



Remote Camera

Settings Guide

CR-N500

CR-N300

Introduction

Thank you for purchasing a Canon Remote Camera (hereafter referred to as the camera)*.

This camera is for indoor use only.

This "Settings Guide" document explains the camera settings and operations. Read this guide carefully before using the camera to ensure correct use. Also, be sure to read the 'Safety Precautions' of the "Installation Guide/Important Information" included with the camera.

* The cameras described in this document may include models not available in your country and/or region.

For the latest information on this product (firmware and software, user manuals, operating environment, etc.), please refer to the Canon website.

Trademarks

- Microsoft, Windows and Microsoft Edge are trademarks or registered trademarks of Microsoft Corporation in the United States and other countries.
- Windows is legally recognized as the Microsoft Windows Operating System.
- macOS is a trademark of Apple Inc., registered in the U.S. and other countries.
- Safari is a trademark of Apple Inc.
- IOS is a trademark or registered trademark of Cisco in the U.S. and other countries and is used under license.
- HDMI is a trademark or registered trademark of HDMI Licensing Administrator, Inc. in the United States and other countries.
- Wi-Fi is a registered trademark of the Wi-Fi Alliance.
- NDI is a trademark or registered trademark of NewTek, Inc. in the United States and other countries.
- All other company or product names used in this document are trademarks or registered trademarks of their respective holders.

Software License Agreement

For the software license agreement, refer to the text file provided with the software and installer.

Except as expressly permitted by the law in effect in the jurisdiction in which you are located, you shall not reverse engineer the firmware which is contained in this product ("Firmware") and you shall not modify the Firmware. TO THE FULL EXTENT PERMITTED BY APPLICABLE LAW, IN NO EVENT SHALL EITHER CANON, OR CANON'S LICENSORS BE LIABLE FOR ANY DAMAGES WHATSOEVER ARISING OUT OF USING THE FIRMWARE. The Firmware may contain third party software components. Notwithstanding anything contained herein to the contrary, the terms and conditions of such third party software components shall be applied to your usage of the Firmware.

Third Party Software

This camera contains third party software modules. Confirm each module's license conditions in [System] > [Maintenance] > [General] > [Tool] > [See Third Party Software License Conditions] on the Settings Page.

Software Licensed Under the GPL and LGPL

If you would like to acquire the source code licensed under the GPL and LGPL, please contact us using one of the following methods:

- (1) To receive an e-mail with the URL to download the source code, access <<https://global.canon/en/oss/scd/index.html>> and complete the request form; or
- (2) To receive the source code by post, send us a letter in writing to the address below with the following information.
In the case you have chosen (2), WE MAY CHARGE YOU for the delivery cost.
 - (i) Your Address (Country/Region, ZIP code, Address, Your name) [mandatory]
 - (ii) Your e-mail address (for the purpose of possible communication with us) [optional]
 - (iii) Product Name/Application Name [mandatory]

(iv) Product/Application Software Version [optional]

If you do not specify a version, we will send source code corresponding to the latest version.

– Address:

Open Source Promotion Division, Canon Inc.

30-2, Shimomaruko 3-chome, Ohta-ku, Tokyo 146-8501, Japan

– For Canon's privacy policy, refer to Canon Global Website <<https://global.canon/>>.

This product is licensed under AT&T patents for the MPEG-4 standard and may be used for encoding MPEG-4 compliant video and/or decoding MPEG-4 compliant video that was encoded only (1) for a personal and non-commercial purpose or (2) by a video provider licensed under the AT&T patents to provide MPEG-4 compliant video. No license is granted or implied for any other use for MPEG-4 standard.

THIS PRODUCT IS LICENSED UNDER THE AVC PATENT PORTFOLIO LICENSE FOR THE PERSONAL USE OF A CONSUMER OR OTHER USES IN WHICH IT DOES NOT RECEIVE REMUNERATION TO (i) ENCODE VIDEO IN COMPLIANCE WITH THE AVC STANDARD ("AVC VIDEO") AND/OR (ii) DECODE AVC VIDEO THAT WAS ENCODED BY A CONSUMER ENGAGED IN A PERSONAL ACTIVITY AND/OR WAS OBTAINED FROM A VIDEO PROVIDER LICENSED TO PROVIDE AVC VIDEO. NO LICENSE IS GRANTED OR SHALL BE IMPLIED FOR ANY OTHER USE. ADDITIONAL INFORMATION MAY BE OBTAINED FROM MPEG LA, L.L.C. SEE [HTTP://WWW.MPEGLA.COM](http://www.mpegla.com)

This product comes with exFAT, a licensed file system technology from Microsoft.

Compliance with Applicable Laws/intellectual Property Rights: Please note that your use of this product may subject you to certain laws, rules and regulations, including but not limited to, privacy, wiretapping and intellectual property and publicity laws. Please be sure your use of this product and/or any resulting recordings or footage complies with applicable laws, rules and regulations.

Canon Inc. and its affiliates shall have absolutely no liability with respect to any claims made by third parties that your use of this product does not comply with applicable laws, rules and regulations and any resulting claims brought against you by third parties alleging non-compliance with such laws, or otherwise violates any third party's intellectual property, personal, privacy or proprietary rights as a result of your use of the product. We are also not responsible to you for any liability whatsoever resulting from your use, and/or installation of this product, and/or any loss of any recordings or footage.

Limited Warranty: Please check the in-box materials for more information about the limited warranty that pertains to your product.

Installation: This product should NOT be installed outdoors. You are solely responsible for the proper installation of this product. **To the extent permitted by law, Canon Inc. and its affiliates shall have absolutely no liability to you with respect to any damages or liabilities associated with the improper use of, or the installation of this product, or for any personal injuries sustained by you or any third parties as a result of any such improper use or installation of this product, whether or not the installation of this product was by you, or by any third party.**

Network Security: You are responsible for the network security of this product and its use. **To the extent permitted by law, neither Canon Inc., nor any of its affiliates shall be liable to you for any losses, direct, indirect incidental or consequential damages or liabilities arising from any security breaches of this product and/or for any resulting claims brought against you by third parties as a result of such security breaches due to network security of this product.** You need to take appropriate steps to help avoid security breaches which, depending on a variety of factors, including your network environment, can include, but may not be limited to, the following:

- Use the product in a network secured by a firewall, or other security protocol
- Set passwords at least 8 characters in length, including at least 3 different types of characters, such as upper case, lower case and symbols and numbers
- Change passwords frequently; avoid sharing passwords
- Change the HTTP port number of the product
- Limit access to the product by other network devices
- Restrict those who log in to the network to those who have authorized user name and password
- After accessing the product as an administrator, be sure to close all web browsers
- Use security software – install appropriate software to protect against intrusions and infections that can compromise the security of the product and its use
- If the product is connected to a network that includes personal computers, make sure that the system is not infected with computer viruses or other malicious programs (using a regularly updated antivirus program, antispyware program, etc.)
- Avoid connections that use public lines
- Do not install the product in locations where the unit, cables and other equipment can be easily accessed, damaged or destroyed by persons with malicious intent
- Security risks and guidelines are always evolving; the above list is intended to include potential steps that can be taken to help avoid security breaches and is not all inclusive. Please consult with an information security specialist for further information.

Privacy:

- Do not install this product in areas where people have a reasonable expectation of privacy, including but not limited to, bedrooms, dressing rooms, locker rooms and rest room facilities.
- Some jurisdictions require signage disclosing the existence of camera equipment. Please check your own area's laws for requirements.
- Making audio recordings is heavily regulated and can vary significantly by area. Please check laws in your jurisdiction before making any audio recordings.

Types of User Manuals

The following describes the different camera user manuals. When you are instructed to reference another manual, its name will be listed as shown below.

"Installation Guide/Important Information" (Included)

This describes safety precautions, procedures for installing the camera, and downloading information from the Canon website.

"Settings Guide" (This Guide)

This explains the camera initial settings, other settings on the Settings Page, troubleshooting, and major specifications, etc.

"Remote Camera Control Application User Manual"

This explains details on how to use the Remote Camera Control Application.

"Remote Camera Controller RC-IP100 User Manual"

This explains details on how to use the Remote Camera Controller RC-IP100.

How to Use This Document

The assumed reading format of this document is on a computer screen.

■ Notes

1. Any unauthorized reproduction of this document is prohibited.
2. The contents of this document are subject to change without any prior notice.
3. This document has been prepared with the utmost attention to accuracy. If you have any comments, however, please contact a Canon sales representative.
4. Canon shall assume no liability for any outcome of using this product, notwithstanding items 2 and 3 above.

■ Software Screenshots

The software screenshots samples shown in this document are for illustration only. The screenshots may differ from the actual screens displayed.

Descriptions use sample screens when connected to the CR-N500, with Windows 10 for the operating system and Google Chrome for the web browser.

■ Symbols Indicating Camera Models

Descriptions that differ depending on the camera model are indicated by the camera name and the following symbols.

Symbol	Model
N500	CR-N500
N300	CR-N300

■ Symbols Used in This Document



Symbol	Meaning
 Caution	Failure to follow the instructions indicated by this symbol may result in property damage other than this product. Be sure to follow these precautions.
 Important	Cautions and restrictions during operation. Make sure to read these carefully.
 Note	Supplementary descriptions and reference information.

Table of Contents

Introduction.....	2
Trademarks	2
Software License Agreement.....	2
Third Party Software.....	2
User Manuals.....	5
Types of User Manuals	5
How to Use This Document	5

Chapter 1

Before Use

Examples of System Configuration.....	12
Related Software	15
Camera Search Tool	15
Remote Camera Control Application	15
Webcam Driver	15
Security Checking/Settings	16
Checking the Firewall Settings (Windows).....	16
Initial Camera Settings.....	17
Settings using the Camera Search Tool	17
Camera's Settings Page from the Web Browser.....	19

Chapter 2

Camera Setup

Overview.....	21
Accessing from a Web Browser	21
Configuration of the Settings Page	23
Camera Operation	25
Operation by Clicking on the Video Display Area or by Slider	25
Exposure Settings.....	27
WB/Color Settings.....	31
Image Quality Settings	33
Image Quality Details Settings	35
Focus Settings (CR-N500).....	37
Autofocus	37
Manual Focus.....	40
Focus Settings (CR-N300).....	42
Autofocus	42
Manual Focus.....	44
PTZ/IS Settings	45
Preset Settings.....	46
Registering Presets.....	46
Calling Presets	47
Deleting Presets.....	47

System Settings	48
Screen Configuration	48
Setting Items	49
Common Operations	49
[System] > [Video and Audio] > [HDMI/SDI]	51
HDMI/SDI	51
SDI	51
[System] > [Video and Audio] > [IP Streaming Video].....	52
Mainstream	52
Substream 1	53
Substream 2.....	53
[System] > [Video and Audio] > [Audio].....	54
General Audio	54
IP Audio Streaming	55
[System] > [Server] > [HTTP/Video].....	56
HTTP Server	56
Video Server.....	56
[System] > [Server] > [RTP]	57
RTP Server	57
Audio Settings.....	57
RTP Mainstream, RTP Substream 1, RTP Substream 2.....	58
[System] > [Communication] > [Network].....	59
LAN	59
IPv4	59
IPv6	60
DNS.....	60
mDNS.....	61
[System] > [Communication] > [Wireless LAN]	62
Interface.....	62
Access Point	62
IPv4	62
[System] > [Communication] > [External Connection (IP)].....	64
Standard Communication (IP).....	64
NDI HX	64
RTMP.....	65
Output Tracking Data.....	65
SRT.....	66
[System] > [Communication] > [External Connection (Serial)]	68
Serial Port.....	68
Standard Communication (Serial).....	69
[System] > [Security] > [Certificate Management]	70
Server Certificate Management	70
Create Certificate	70
[System] > [Security] > [SSL/TLS]	71
Encrypted Communications.....	71
Server Certificate	71

[System] > [Security] > [User Management]	72
Administrator Account	73
Authorized User Account.....	73
User Authority	73
[System] > [Security] > [Host Access Restrictions]	74
IPv4 Host Access Restrictions	74
IPv6 Host Access Restrictions	74
[System] > [System] > [Camera]	76
Camera Name.....	76
Installation Conditions.....	76
Tally Lamp.....	76
IR Remote Controller	77
Genlock.....	77
[System] > [System] > [Date and Time].....	78
Current Date and Time.....	78
Settings	78
[System] > [System] > [Environment]	80
Environment	80
[System] > [System] > [Language]	81
Language.....	81
[System] > [Maintenance] > [General]	82
Device Information	82
Tool	82
Initialization	82
[System] > [Maintenance] > [Backup/Restore]	84
Backup/Restore	84
[System] > [Maintenance] > [Update Firmware]	85
Device Information	85
Update Firmware	85
[System] > [Maintenance] > [Log]	86
View Logs.....	86

Chapter 3

IR Remote Controller

Names and Functions of Parts	88
Handling the Remote Controller	90

Chapter 4

Appendix

USB Camera Functions (CR-N300)	92
Image Adjustment/Camera Control Functions.....	92
Troubleshooting	93
List of Log Messages	95
Log Messages on the Camera.....	95
Error Log	95
Warning log.....	97
Notification log	98

Restoring to the Factory Default Settings	102
Restoring to the Initial Settings from a Web Browser.....	102
Restoring to the Factory Default Settings with the RESET Switch on the Camera.....	102
List of Factory Default Settings	104
Routine Maintenance	107
Cleaning the External Surface	107
Cleaning the Lens	107
Specifications	108
CR-N500 Main Unit	108
CR-N300 Main Unit	110
Accessories	112
Operating Environment	113
Security Measures	114
Basic Measure 1: Setting Administrator Name and Password	115
Basic Measure 2: Using the Latest Firmware	115
Basic Measure 3: Setting Date and Time	115
Basic Measure 4: Monitoring the Log	115
Measures Suitable to the Users' Environment 1: User Management	116
Measures Suitable to the Users' Environment 2: Host Access Restrictions	116
Measures Suitable to the Users' Environment 3: Setting to the Digest Authentication.....	116
Measures Suitable to the Users' Environment 4: Changing the Port Number	117
Measures Suitable to the Users' Environment 5: Encrypting Communication.....	117
Measures Suitable to the Users' Environment 6: Disabling Unused Functions.....	117
Precautions When Disposing the Camera	118
Encrypting Backup Information	118
Index.....	119

Chapter 1

Before Use

This chapter explains the software related to the camera and examples of system configuration. It also describes the preparation and settings after installing the camera.

Examples of System Configuration

System Layout

This camera can be used by connecting with the following devices.

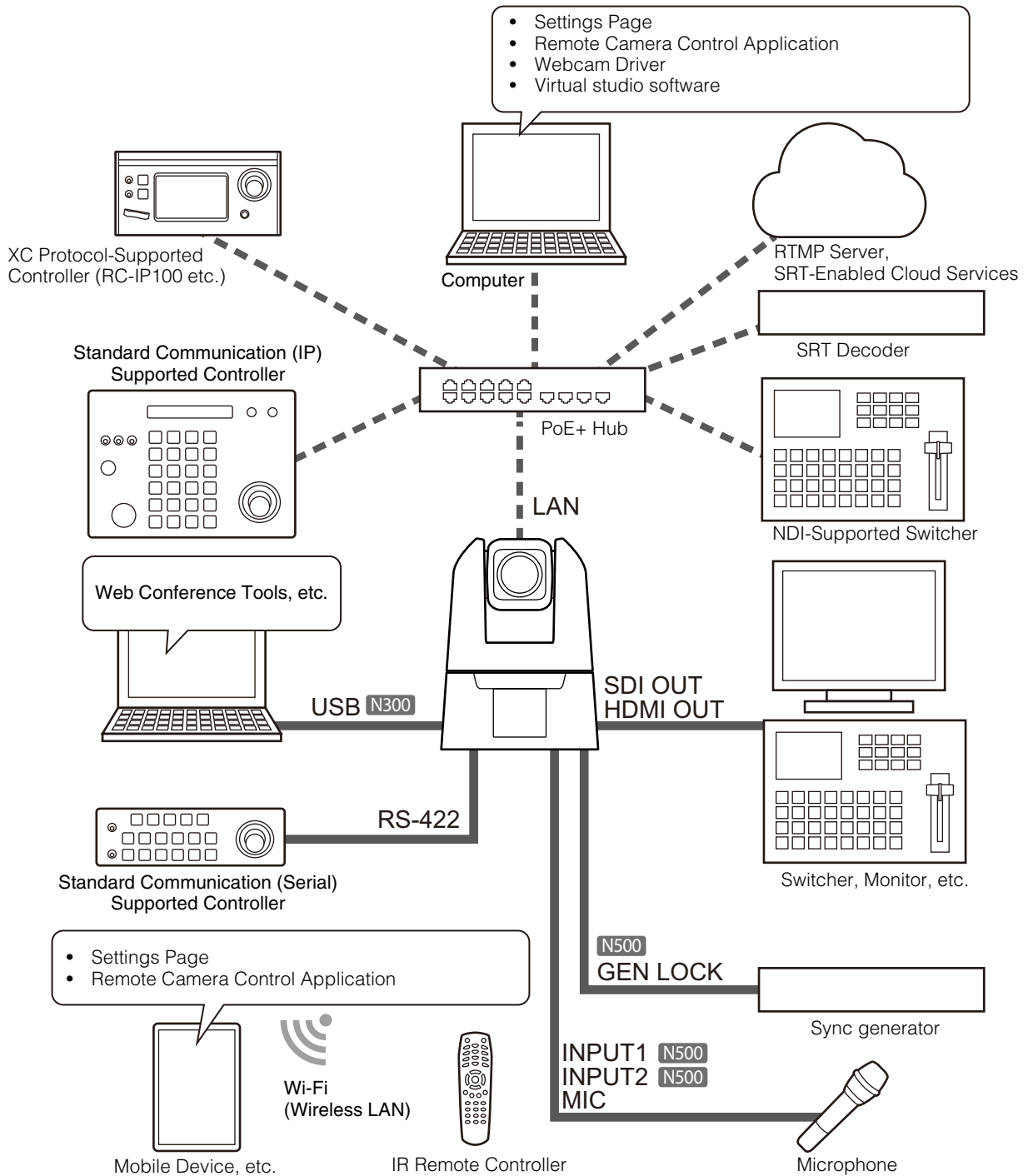

Note

For details on IR remote controller, refer to "Chapter 3 IR Remote Controller" (P. 87).

System Layout Example 1

The following is an example of a connection in which a network connected controller controls multiple cameras and outputs SDI.

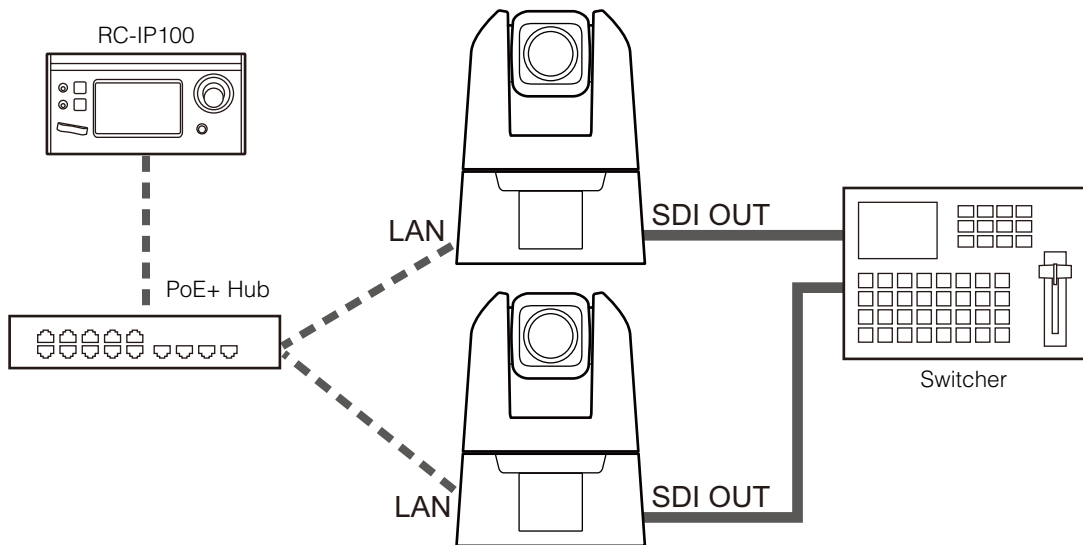

System Layout Example 2

The following is an example of network connected camera control using application.

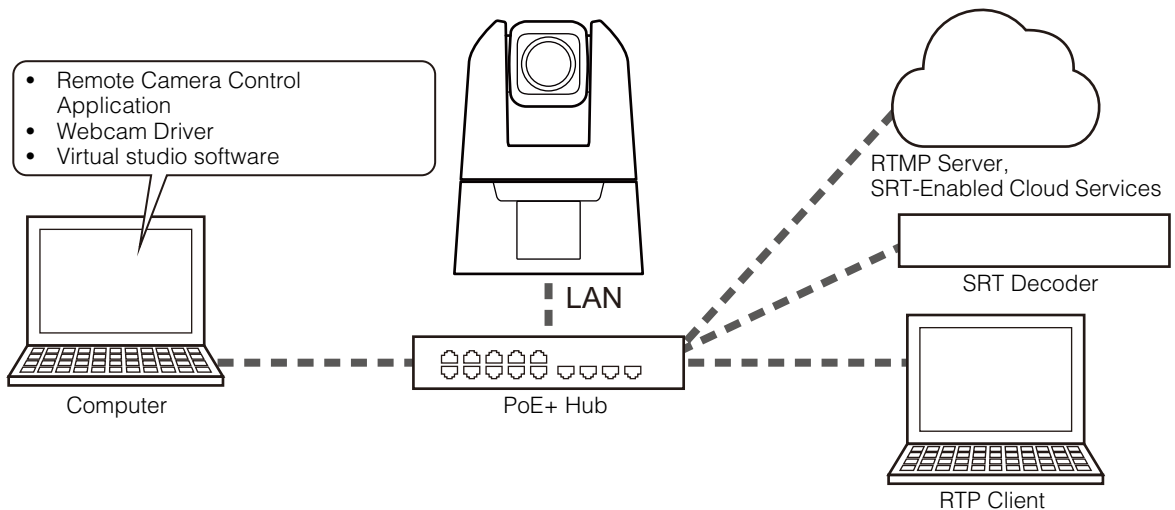

System Layout Example 3

The following is an example with no network connection. Even if network communication is not used during shooting, it is necessary to connect to the network beforehand and perform the initial settings from the computer.

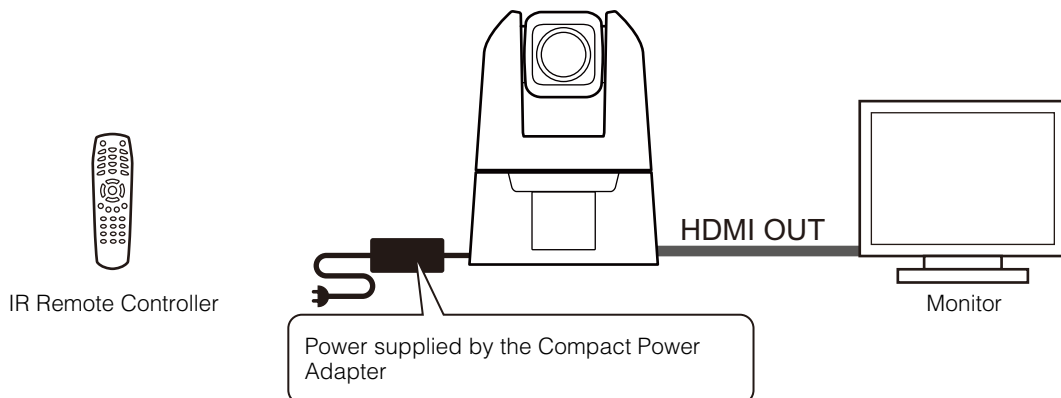

■ System Layout Example 4

The following is an example of connecting the camera as a USB camera. It is necessary to connect a headset, microphone, speakers, etc. to the computer separately, to hold web conferences.

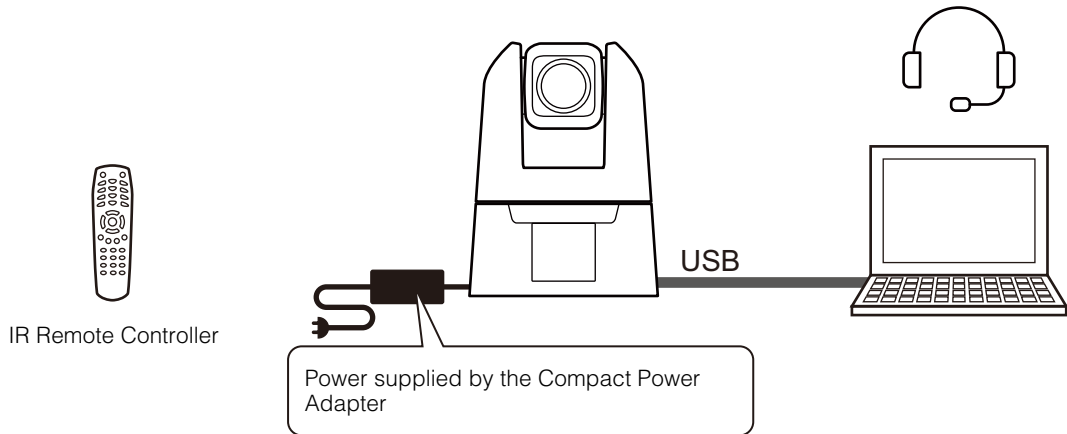

Related Software

The following software can be used to set up and operate the camera efficiently. Download the software to use from the website written in the "Installation Guide/Important Information".

Camera Search Tool

This tool is used for connecting the camera to the computer over a network first. For details, refer to "Initial Camera Settings" (P. 17).

Remote Camera Control Application

This software is used for operating cameras while checking the camera videos. This software can perform the following operations on the camera.

- Pan, Tilt, Zoom operation
- Preset movement
- Trace function

For details on uses and functions, refer to "Remote Camera Control Application User Manual".

Webcam Driver

This software allows the use of the IP streaming video with web conference tools. For details, refer to the "Webcam Driver User Manual".

Security Checking/Settings

The security function of the OS or web browser may block the setting and operation of the camera. Check the security settings beforehand, and change the settings if required.

Checking the Firewall Settings (Windows)

To use the software on a computer with Windows Defender Firewall enabled, it is necessary to add each piece of software as an application that allows communication through the firewall.



Note

If applications were not added in this procedure, they can still be added as allowed applications in the [Windows Security Alert] dialog that appears when starting the software.

- 1** Click [Windows Defender Firewall] in [Control Panel] > [Systems and Security].
- 2** Click [Allow an app or feature through Windows Defender Firewall].
- 3** Click [Change Settings] > [Allow another app].
- 4** Select [CameraSearchTool.exe] downloaded from homepage, and click [Add].

Initial Camera Settings

In order to use the camera, it is necessary to first connect the computer to the camera via network then set the Administrator Account.

Settings using the Camera Search Tool

Here, by using the camera search tool and accessing the camera's initial settings screen, the method to initialize the camera to the factory default settings is explained.

Camera detection by this tool is valid only for cameras in the same network.

- 1 Connect the camera to the computer on the same network, then turn on the power.
- 2 Double-click the Camera Search Tool icon downloaded from the website.



Windows : CameraSearchTool.exe
macOS : Camera Search Tool.app

When starting this tool, cameras on the same network are automatically detected and the acquired information is displayed in a list.

In the case the camera is not automatically detected, click [Search Camera].

Note

- Even if the network addresses of the computer and the camera are different, if IPv6 of the computer is enabled, the camera will be detected using the IPv6 link-local address.
- If IPv6 is not available, either assign an IPv4 address on the DHCP server or use the AutoIP feature to detect the camera. To use the AutoIP function, configure the following setting and then connect the computer and camera to a network environment without a DHCP server. Each computer and camera will be assigned an IPv4 link-local address of 169.254.xxx.xxx and will belong to the same network, so the camera can be detected.

Windows: Set [Obtain an IP address automatically] in the network settings

macOS: Set [Configure IPv4] to [Using DHCP] in [System Preferences] > [Network].

- 3 Click the IP address of the camera to be initialized

Windows :

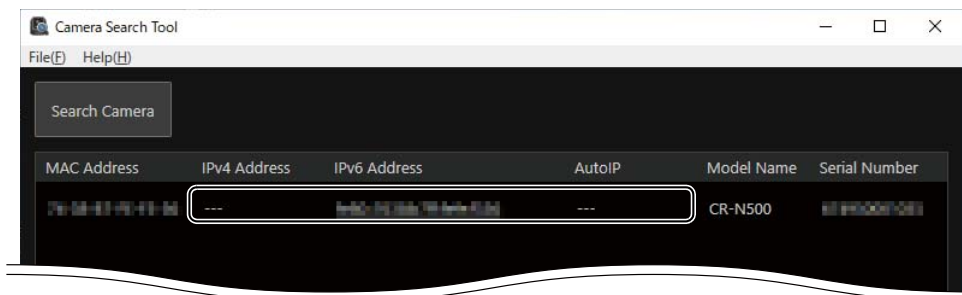

macOS :

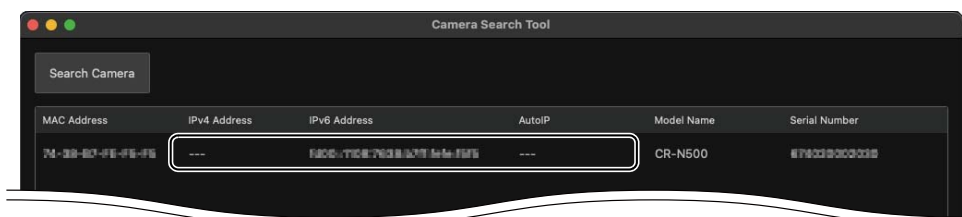

The web browser starts and the [Default Settings (1/2)] screen of the camera is displayed.

4 Enter the Administrator Name and Administrator Password, select [Language], and click [Apply and Reboot].

After rebooting the camera, the [Default Settings (2/2)] screen is displayed.



Important

To ensure system security, set the administrator password that should not be easily guessed by third parties. Be sure not to forget the new password.

5 Set the [Frame Frequency (Hz)], [Network], and [Date and Time], then click [Apply] or [Apply and Reboot].

After the camera reboots, the Settings Page is displayed and settings are able to be configured.

If the [Network] settings are changed, the camera may be unable to be connected from the operating web browser. In this case, confirm the set network settings and its connected computer then reconnect. For details on the settings, refer to "System Settings" (P. 48).



Note

- The video size and frame rate options for the output video are determined according to the set frame frequency.
- When using the camera as a USB camera, set the frame frequency to 59.94 Hz or 50.00 Hz. **N300**

6 Repeat steps 3 to 5 to initialize multiple cameras.

To exit the camera search tool, click [Exit] in the menu or click the **X** button of the window.

Camera's Settings Page from the Web Browser

Able to access the camera by directly specifying the IP address from a web browser.

If there is an IP address assigned by the DHCP server, specify it, otherwise specify "192.168.100.1".



Important

- Able to access with the IP address of 192.168.100.1 approximately 2 minutes after connecting the camera to the network environment.
- If an IPv4 address is assigned by the DHCP server, it will switch to that address and access by 192.168.100.1 will not be possible.
- If there are devices with 192.168.100.1 on the same network, the same IP address will be assigned, and access to the camera with 192.168.100.1 will not be possible.

1 When accessing with 192.168.100.1., set the IP address of the computer.

Set the IP address of the computer to the same network as 192.168.100.1 such as 192.168.100.xxx.

2 Launch the web browser.

3 Enter the camera's IP address in the address column of the web browser and press [Enter].

The [Default Settings (1/2)] screen of the camera is displayed.

4 Perform steps 4 to 5 of the previous section "Settings for the Camera Search Tool".

After the camera reboots, the Settings Page is displayed and settings are able to be configured.



Note

If necessary, restore the computer settings changed in step 1.

Chapter 2

Camera Setup

The settings required to use the camera are made on the Settings Page. Before starting operation, make various settings on the Settings Page according to the shooting conditions and purpose. There are also menus that can be performed during operation, such as camera maintenance.

Overview

Follow the steps below to connect to cameras either by wires or wirelessly and to display the Settings Page.

Accessing from a Web Browser

Follow the steps below to display the Settings Page according to the connection method to the camera (wired or wireless LAN).

The Settings Page can only be connected with an Administrator Account.

Important

- In the case the Administrator Account is forgotten, return settings to factory default settings (P. 102). However, because the Administrator Account and other settings will be initialized, it will no longer be able to connect to the camera as it is. Use the Camera Search tool to perform initialization setting.
- Do not open multiple Setting Pages at one time and try to change the settings of a single camera.

■ For Wired LAN

Enter the IP address set in "Initial Camera Settings" (P. 17) directly into the web browser to display the Camera's Settings Page

- 1** Launch the web browser.
- 2** Enter the IP address and press Enter
The authentication screen of the Settings Page is displayed.
- 3** Enter Administrator Name and Administrator Password, then click [Sign in]

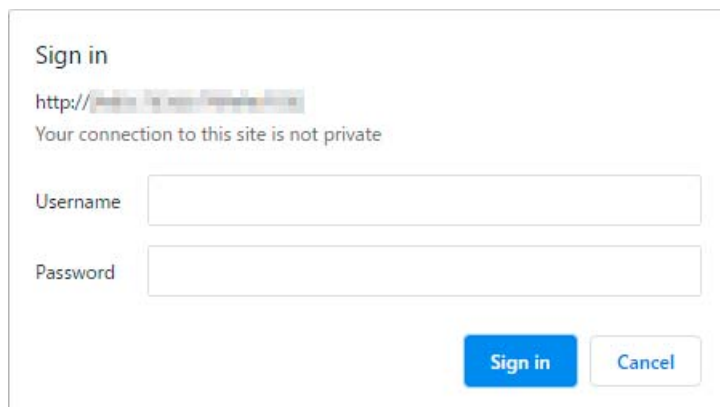

The Settings Page is displayed.

■ For Wireless LAN

Even when using with a wireless LAN, it is necessary to first connect with a wired LAN and configure the wireless LAN settings.

- 1** Display the Settings Page according to the procedure in the previous section "For Wired LAN"
- 2** Enable wireless LAN.
Click the [System] tab and set [Wireless LAN] to [Enable] in [Communication] > [Wireless LAN], configure

[Access Point] and [IPv4], then restart the camera.

The screenshot shows the 'Wireless LAN' configuration interface. At the top right, there are buttons for 'Reboot', 'Apply', and 'Clear'. The 'Interface' section has a dropdown menu for 'Wireless LAN' set to 'Enable'. The 'Access Point' section includes fields for 'SSID' (XXXXX), 'Authentication Method' (WPA2-PSK/WPA3-SAE mix), 'Password' (masked), 'Confirm Password' (masked), and 'Channel Setting' (1). The 'IPv4' section has fields for 'IPv4 Address' and 'Subnet Mask', both set to 192.168.1.1.

For details, refer to [System] > [Communication] > [Wireless LAN] (P. 62).

3 Connect devices (computers and mobile devices) to be used to the camera

Enable the wireless LAN settings on devices to be used and connect to the access point with the SSID that was configured in step 2.

4 Re-display the Settings Page by following the procedure in the preceding section in "For Wired LAN"

Enter the IP address configured in step 2.

■ Cautions and Troubleshooting for Wireless LAN Connection

If experiencing "Slow down of network speed" or "lost connection" while using a wireless LAN, refer to the following examples.

How to install network devices (Wireless LAN support)

- When using a wireless LAN indoors, install the camera and network device in the same room.
- Install the camera and network device in a location with good visibility, where there is no interference from people or objects.
- Place the camera and network device as close to each other as possible. If necessary, change the installation height and orientation.

Surrounding Electronic Devices

- If the network speed becomes slow due to the influence of nearby electronic devices (radio interference), changing the channel may solve the problem.
- IEEE 802.11 b/g/n wireless LANs use the same 2.4 GHz frequency band as microwave ovens, cordless phones, wireless microphones, and Bluetooth devices. This slows down the network speed if these devices are in the vicinity.
- If an access point that uses the same frequency band as the camera is operating nearby, the network speed will be slower.

Using Multiple Cameras

- Do not duplicate IP addresses of devices in the same network.
- To reduce radio interference, set a four-channel interval for the wireless LAN, for example, "1, 6, 11", "2, 7, 12", or "3, 8, 13".

Configuration of the Settings Page

The configuration of the Settings Page is as follows:

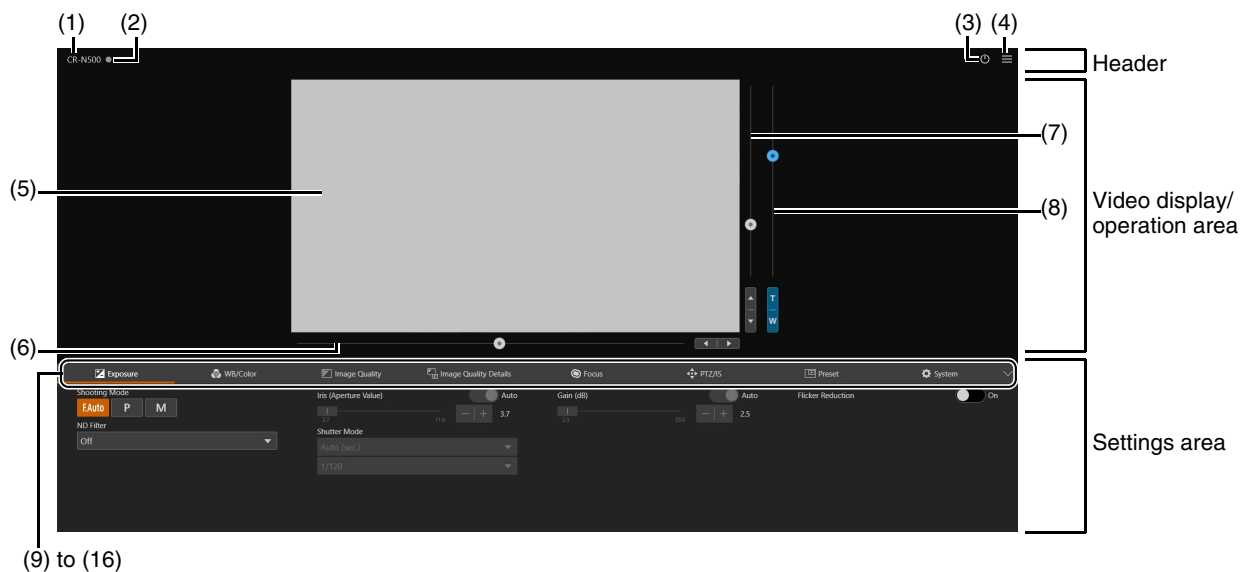

■ Header

This area is common to all Settings Pages.

- (1) **Model Name**
Displays the model name of the connected camera.
- (2) **Tally Lamp Status Display**
Displays the video distribution status on the Tally Lamp.
 - : Distributing
 - : Preparing for distribution
 - : No distribution
- (3) **Power ON/Standby**
Switches between the camera on and standby mode. Set it to standby mode if needing to stop HDMI/SDI output or IP distribution of videos.
If  is clicked while the camera is on, "This will switch to standby. Do you want to continue?" message will appear. Click [OK] and "On Standby" will appear in the video display area and will go into standby mode. Click [Start Up] to return to the power on state.

The power lamp on the front of the camera is as follows:
On (green): Power on
ON (orange): Standby
Blinking (green): Changing to or from standby
- (4)  **Menu**
Click to display a list of items in the settings area.
For details of the items, refer to the "Settings Area" (P. 24).

■ Video Display/Operation Area



Displays the video received from the camera. Also, operates the pan, tilt, and zoom of the camera.

(5) Video Display Area



JPEG video is displayed.

When the image cannot be displayed, the  Reconnect button appears in the center of the screen.

(6) Pan Slider (P. 25)

Move the camera angle left or right. Use the  or  button to fine-tune the position.

(7) Tilt Slider (P. 25)

Move the camera angle up or down. Use the  or  button to fine-tune the position.

(8) Zoom Slider (P. 25)

Move up to zoom in (telephoto) or down to zoom out (wide angle).

Use the T or W button to fine-tune the position.

■ Settings Area

Change camera settings. Click each tab to switch the settings area.

(9) [Exposure] tab (P. 27)

Sets exposure settings.

(10) [WB/Color] tab (P. 31)

Sets the white balance and color matrix settings.

(11) [Image Quality] tab (P. 33)

Sets the image quality.

(12) [Image Quality Details] tab (P. 35)

Sets advanced image quality settings.

(13) [Focus] tab (P. 37, 42)

Sets focus settings.

(14) [PTZ/IS] tab (P. 45)

Sets pan, tilt, and zoom operations and image stabilizer settings.

(15) [Preset] tab (P. 46)

Sets the preset settings.

(16) [System] tab (P. 48)







Configure advanced camera system settings such as video and audio, server, communications, and security.

If this tab is clicked, the video display/operation area disappears, and the screen will be configured with the setting item category and the settings screen.

Important

Do not use the [Back] and [Forward] buttons on the Web browser to navigate through the settings page. The changed settings may be reverted or unintended changes may be applied.

Note

- By clicking  at the right of the tab area, the Settings area will be hidden, and only the video display/operation area will be displayed. It will be reverted by clicking .
- If the width of the screen is narrow, tabs can be switched by using the   buttons. Also, for each Settings area, it is possible to switch the display by using the   buttons at the bottom of the screen or by clicking .

Camera Operation

Set the camera angle by operating the camera's pan, tilt and zoom.

Note

Camera control by clicking and dragging does not guarantee exact precision.

Operation by Clicking on the Video Display Area or by Slider

Click Operation

When clicking on the video display area, the camera angle moves so that the position of the mouse pointer is at the center.

If a single click does not center to the desired location, repeat the operation.

Note

When operating [Focus], the camera angle cannot be centered by clicking on the video display area.

Slider Operation

Dragging the pan and tilt slider knobs pans and tilts the camera.

Drag the zoom slider knob to operate the zoom.

The slider knob moves even if clicking the slider on the point without the knob.

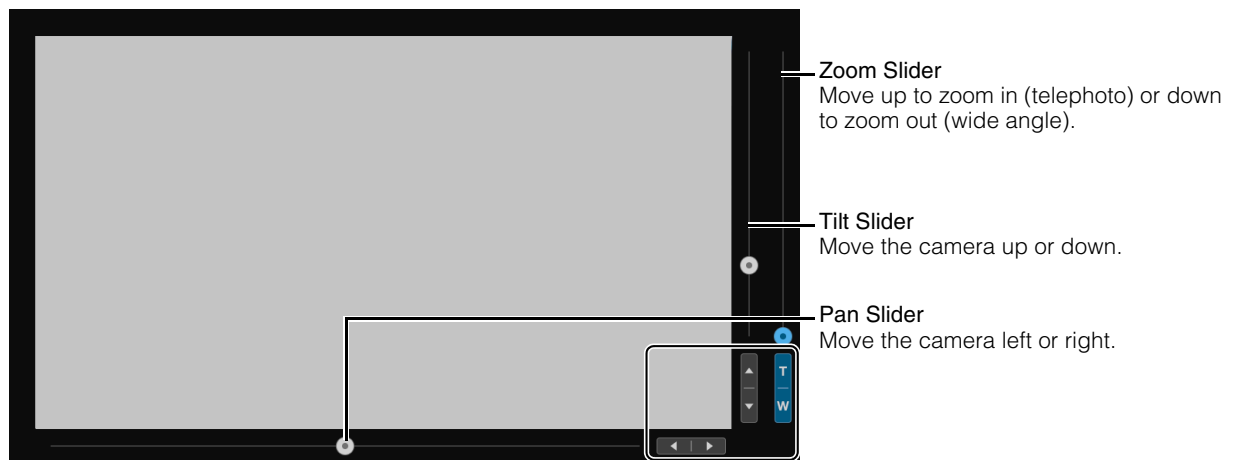

Fine tune the pan, tilt, and zoom positions by clicking the ◀ or ▶, ▲ or ▼, or T or W buttons.

■ Slider Operation When Using the Digital Zoom and Digital Tele-Converter

When [PTZ/IS] > [Digital Zoom] is set to [300x] **N500**, [400x] **N300**, the digital zoom area is displayed on the zoom slider and digital zoom operation is enabled.

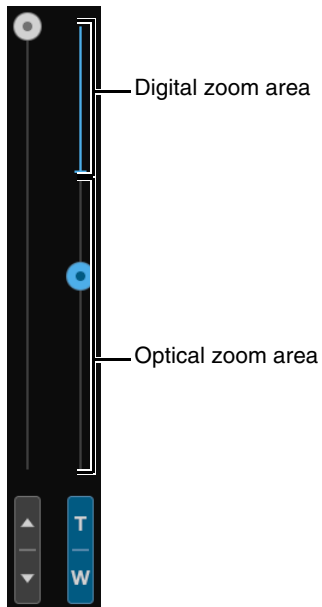

When [PTZ/IS] > [Digital Zoom] is set to [Digital Tele-Converter] (P. 45), the video is magnified according to the magnification selected, but the position of the slider does not change.

Exposure Settings

Settings for the shooting mode according to the shooting environment and subject, as well as the iris, shutter speed, and gain.

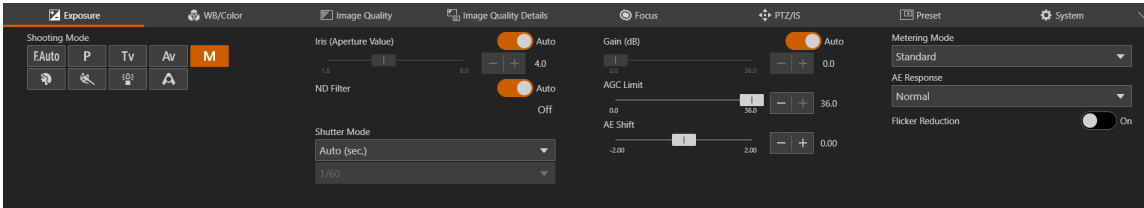

[Shooting Mode]

Switches the shooting mode according to the shooting environment and subject.

F.Auto (Full Auto)

The exposure (iris, shutter speed, gain, etc.) and white balance settings are adjusted automatically.

P (Program AE)

The exposure (iris, shutter speed, gain, etc.) settings are adjusted automatically. It is possible to set [AGC Limit], [AE Shift], [Metering Mode], and [AE Response].

Tv (Shutter Priority AE) **N300**

The shutter speed is adjusted manually. The gain and iris are adjusted automatically.

Av (Iris Priority AE) **N300**

The iris is adjusted manually. The shutter speed and gain are adjusted automatically.

M (Manual Exposure)

The exposure (iris, shutter speed, gain, etc.) is adjusted manually.

(Portrait) **N300**

Blurs the background to make the subject stand out.

(Sports) **N300**

Captures fast moving subjects.

(Low Light) **N300**

Brightly captures subjects in dark locations.

(Spotlight) **N300**

Captures subjects illuminated by a spotlight beautifully.

Note

- In (Portrait), (Sports), (Low Light), and (Spotlight), the exposure (iris, shutter speed, gain, etc.) settings are adjusted automatically. In the [WB/Color] tab, only [White Balance Mode] and [Color Temperature (K)] are displayed. The [Image Quality] tab and the [Image Quality Details] tab cannot be selected. **N300**
- In (Portrait) and (Sports), the captured video may not appear smooth or may flicker. **N300**
- For precautions regarding shooting in (Shutter Priority AE) and (Low Light), refer to "About Shooting with Slow Shutter" (P. 30). **N300**
- The items that can be set differ depending on the shooting mode. The details are shown below.
 ○: Items which can be set
 ●: Items which are set automatically
 -: Items which cannot be set

Item	Shooting Mode						
	F.Auto	P	N300 Tv	N300 Av	M	N300 	
Iris	●	●	●	○	○	●	
ND Filter	N500	○	/		○	/	
	N300	●	○*1	○*1	○*2	○*2	●
Shutter Mode	●	●	○*3	●	○	●	

Item	Shooting Mode					
	F.Auto	P	N300 Tv	N300 Av	M	N300 [Portrait] [Sports] [Low Light] [Spotlight]
Gain	●	●	●	●	○	●
AGC Limit	–	○	○	○	○	–
AE Shift	–	○	○	○	○*4	–
Metering Mode	–	○	○	○	○	–
AE Response	–	○	○	○	○	–
Flicker Reduction	○	○	○	○	○	○
Auto Slow Shutter	N300 ○	○	–	–	–	–

*1 Possible to select [Auto] or off.

*2 Linked to the iris settings.

*3 Possible to set the shutter speed.

*4 Possible only if one of Shutter Mode, Iris and Gain is set to [Auto].

[Iris (Aperture Value)]

Adjusts the iris (aperture) according to the brightness of the subject.

When [Auto] is set, the iris is automatically adjusted.

When [Auto] is off, the iris can be manually adjusted. Moving the slider to the left opens the aperture and brightens the video. Moving it to the right narrows the aperture and darkens the video. Following aperture values can be set.

N500 F2.8, F3.1, F3.4, F3.7, F4.0, F4.4, F4.5, F4.8, F5.2, F5.6, F6.2, F6.7, F7.3, F8.0, F8.7, F9.5, F10, F11

N300 F1.8, F2.0, F2.2, F2.4, F2.6, F2.8, F3.1, F3.4, F3.7, F4.0, F4.4, F4.8, F5.2, F5.6, F6.2, F6.7, F7.3, F8.0

The aperture value that can be set differs depending on the zoom position. Reference aperture value is displayed on the screen.

N500 Maximum wide angle: F2.8 to F11, maximum telephoto: F4.5 to F11

N300 Maximum wide angle: F1.8 to F8.0, maximum telephoto: F2.8 to F8.0

Note

- By changing the depth of field and blur the background or surroundings to make the subject stand out, set a smaller aperture value, and to keep everything from close objects to far-away objects in focus, set a larger aperture value.
- When shooting in a bright location, narrowing down the iris can cause blurring. It is possible to prevent blurring by adjusting the ND filter and shutter speed and opening the iris.
- When [AUTO] of the iris is set to off, the aperture value from Auto is inherited. The aperture value before setting to [AUTO] is not restored.

[ND Filter] **N500**

Choose whether to use the ND filter. ND filter can be switched to three levels (1/4, 1/16, 1/64). The ND filter allows to open the aperture for a video with shallow depth of field even in a bright environment. This is also convenient for avoiding blur caused by narrowing down the aperture.

Note

Changing the ND Filter settings in certain shooting conditions could generate some slight change in coloring. In this case, it is effective to set the white balance when shooting (P. 31).

[ND Filter] **N300**

When the [Shooting Mode] is set to **Av** (Iris Priority AE) or **M** (Manual Exposure) and the [Iris (Aperture Value)] is F4.0 or larger, ND filter is automatically adjusted linked to the setting of the iris. In other shooting modes, when [Iris (Aperture Value)] is F4.0 or larger, the exposure is automatically adjusted using the ND filter.

In **Av** (Iris Priority AE), **M** (Manual Exposure), **P** (Program AE), or **Tv** (Shutter Priority AE), in order to adjust the exposure without using the ND filter, [Auto] can be set to off.

Note

When the [Shooting Mode] is set to **F.Auto** (Full Auto), **[Portrait]** (Portrait), **[Sports]** (Sports), **[Low Light]** (Low Light), or **[Spotlight]** (Spotlight), ND filter is always automatically adjusted.

[Shutter Mode]

Adjusting the shutter speed enables to adapt to the subjects and the shooting environment, making it possible to capture fast-moving subjects (sports, vehicles, etc.) clearly and brighten low-light scenes, etc. Shutter speed can be adjusted in the following modes:

[Auto (sec.)]

Automatically adjusts the shutter speed according to the brightness of the video.

[Speed (sec.)]

Sets the shutter speed to seconds. The shutter speed can also be set to a value higher than the frame rate.

[Slow (sec.)]

Sets the shutter speed slower than the frame rate to seconds. This setting is used for shooting in low-light areas. Also, special effects such as "blurring the background" and "adding residual image effects to zoom" are available for shooting a moving subject with pan operation.

For precautions when shooting in slow, refer to "About Shooting with Slow Shutter" (P. 30).

[Clear Scan (Hz)]

Sets the shutter speed by frequency. This is used to reduce black bands on the screen, flickering from fluorescent lighting, and to fine tune the brightness.

The shutter speed that can be selected differs depending on the frame frequency.

Shutter Mode	Frame Frequency (Hz)				
	23.98	29.97	59.94	25.00	50.00
Auto (sec.)	1/24 - 1/2000	1/30 - 1/2000	1/60 - 1/2000	1/25 - 1/2000	1/50 - 1/2000
Speed (sec.)	1/24 - 1/2000	1/30 - 1/2000	1/60 - 1/2000	1/25 - 1/2000	1/50 - 1/2000
Slow (sec.)	N500 1/3, 1/6, 1/12	1/4, 1/8, 1/15	1/4, 1/8, 1/15, 1/30	1/3, 1/6, 1/12	1/3, 1/6, 1/12, 1/25
	N300 1/6, 1/12	1/8, 1/15	1/8, 1/15, 1/30	1/6, 1/12	1/6, 1/12, 1/25
Clear Scan (Hz)	23.98 - 250.38	29.97 - 250.38	59.94 - 250.38	25.00 - 250.40	50.00 - 250.40

Note

- When the [Shooting Mode] is set to **Tv** (Shutter Priority AE), the shutter speed value can be set as follows according to the frame frequency. **N300**
 - At 23.98, 25.00, or 50.00 Hz: 1/6 to 1/2000 sec.
 - At 29.97 or 59.94 Hz: 1/8 to 1/2000 sec.

[Gain (dB)]

Able to set the amplification amount of the video amplifier.

When [Auto] is set, the gain is automatically adjusted. By setting the [AGC Limit], the maximum gain can be limited.

When [Auto] is off, the gain can be manually adjusted. Adjustment can be made in the ranges below.

N500 -6.0 to 33.0 dB (by 0.5)

N300 0.0 to 36.0 dB (by 0.5)

When [Image Quality] > [Gamma] is [Wide DR] or [Canon Log3], the adjustment range is 2.5 to 33.0 dB. **N500**

Note

Increasing the gain may cause a slightly grainy screen. Also, uneven colors, white dots, and vertical lines may appear on the screen.

[AGC Limit]

Able to suppress the occurrence of grainy screen, uneven colors, white dots, vertical lines, etc. by limiting the maximum value when the gain is set to [Auto].

Adjustment can be made in the ranges below.

N500 -6.0 to 33.0 dB (by 0.5)

N300 0.0 to 36.0 dB (by 0.5)

When [Image Quality] > [Gamma] is [Wide DR] or [Canon Log3], the adjustment range is 2.5 to 33.0 dB. **N500**

Note

When the shooting mode is **F.Auto** (Full Auto), the [AGC Limit] value will not be applied. It will be limited by the maximum values below.

N500 Maximum 33.0 dB

N300 Maximum 24.0 dB

[AE Shift]

When one of the [Iris (Aperture Value)], [Shutter Mode] or [Gain (dB)] is set to auto, the exposure can intentionally be compensated to capture subjects either at a brighter or darker exposure.

Move the slider to a negative value to darken the image, or to a positive value to lighten it. Adjustment can be made in the range of -2 levels to +2 levels (by 0.25).

[Metering Mode]

When one of the [Iris (Aperture Value)], [Shutter Mode] or [Gain (dB)] is set to Auto, and the metering mode is set to match the shooting scene, it is possible to shoot with more appropriate brightness.

[Standard]

Meters the entire screen while focusing on the subject in the center of the screen.

[Backlight]

Controls darker areas of the screen more brightly when shooting backlight scenes.

[Spotlight]

Controls the brightness of the subject in the spotlight.

[AE Response]

Select the response of AE when one of the [Iris (Aperture Value)], [Shutter Mode] or [Gain (dB)] is set to Auto. The set values are High, Normal, and Low in order of the shortest time to achieve the proper exposure.

[Flicker Reduction]

Setting [On] automatically detects and corrects flickering from fluorescent lights.



Note

- Erroneous flicker detection may cause horizontal noise. In this case, avoid using [Flicker Reduction].
- When the frame frequency is 23.98 Hz, flicker reduction is not effective even when set.
- When shooting under an artificial light source such as a fluorescent lamp, mercury lamp, or halogen light, flicker may occur in principle depending on the shutter speed set. It may be possible to suppress flicker by setting the shutter speed according to the frequency of the power supply. For 50 Hz, select 1/50 second* or 1/100 second; for 60 Hz, select 1/60 second or 1/120 second.
* Not available depending on the frame frequency.

[Auto Slow Shutter] **N300**

When shooting in a place with insufficient light (such as a room with low light), slows down the shutter speed automatically and adjust to make the video brighter.

Possible to set when the shooting mode is **FAuto** (Full Auto) and **P** (Program AE).



Note

- The slowest shutter speed for each frame frequency differs as follows.
At 23.98 Hz: 1/12 sec.
At 29.97 HZ: 1/15 sec.
At 59.94 Hz: 1/30 sec.
At 25.00 Hz: 1/12 sec.
At 50.00 Hz: 1/25 sec.
- Auto slow shutter cannot be used under the conditions below.
 - When AGC limit is enabled
 - When frame frequency is 23.98 Hz, 29.97 Hz, or 25.00Hz, and [Focus] > [Face Detection AF] is [Face Det. & Tracking] or [Face Only]
- For the precautions when shooting with auto slow shutter, refer to the following section “About Shooting with Slow Shutter”.

■ About Shooting with Slow Shutter

By setting the [Shooting Mode] to **M** (Manual Exposure) or **Tv** (Shutter Priority AE) **N300** to set a slow shutter speed, setting it to **☺** (Low Light) **N300**, or setting the [Auto Slow Shutter] **N300** to [ON], it is possible to shoot the subject brightly even where the light is insufficient. However, depending on the scene or the subject, the following may occur.

- Noticeable residual image from moving subjects
- Deterioration of image quality
- White spots on the screen
- Autofocus not functioning well

WB/Color Settings

Setting the white balance and color matrix settings.

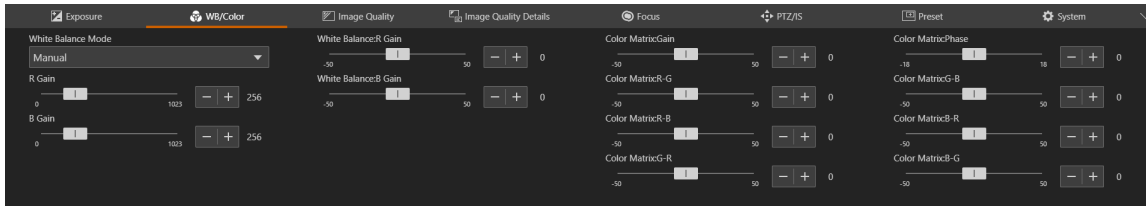

Note

- When [Exposure] > [Shooting Mode] is **F.Auto** (Full Auto), [White Balance Mode] is AWB fixed.
- When [Exposure] > [Shooting Mode] is **Portrait**, **Sports**, **Low Light**, or **Spotlight**, only [White Balance Mode] (AWB fixed) and [Color Temperature (K)] are displayed. **N300**

[White Balance Mode]

Sets white balance according to the color temperature of light sources such as illuminations and daylight. Adjustment procedure is as follows:

[AWB]

Adjust the white balance so that it is always optimal. The white balance is automatically adjusted as the color temperature of the light source changes.

[Daylight]

Sets the white balance according to the daylight (approx. 5600 K).

[Tungsten]

Sets the white balance according to tungsten lighting (approx. 3200 K). Use this setting when shooting under tungsten or tungsten colored fluorescent lighting.

[Color Temperature (K)]

Specify the color temperature in range of 2000 K to 15000 K to adjust the white balance.

[Manual]

Set [R Gain] and [B Gain] as desired.

[Set A] , [Set B]

Executing [White Balance Calibration] captures the reference white color in the actual shooting environment. Illuminate a gray card or white subject (white paper, etc.) with a light source and click [White Balance Calibration] while the subject fills the screen.

Possible to register two settings: [Set A] and [Set B].

The settings are erased after the camera is restarted or turned off/on, so register them as a preset in order to save the settings.

Note

- When shooting under the following conditions, if the screen color looks unnatural in [AWB], adjust the white balance using [Set A] or [Set B]:
 - Shooting in locations where lighting conditions suddenly change
 - Close-up shooting
 - Shooting a scene with only one color, such as sky, sea, or forest
 - Shooting under mercury lamps and certain fluorescent/LED lights
- If the setting is other than [AWB], and the location or brightness changes or the ND filter is switched, adjust the white balance again.

[White Balance:R Gain]

Adjusts the shift amount of the red tint in the white balance.

[White Balance:B Gain]

Adjusts the amount of blue tint shift in the white balance.

[AWB Response]

Selects the responsiveness when [White Balance] is set to [AWB].

The set values in the order of the shortening time required to achieve the proper white balance are High, Normal, and Low.

[Color Matrix: Gain], [Color Matrix: Phase], [Color Matrix: R-G], [Color Matrix: R-B], [Color Matrix: G-R], [Color Matrix: G-B], [Color Matrix: B-R], [Color Matrix: B-G]

The color matrix allows to fine-tune the tone of the video.

Settings	Adjustment Items
Gain	Color depth
Phase	Hue
R-G	Cyan to green and red to magenta color tones
R-B	Cyan to blue, red to yellow color tones
G-R	Magenta to red and green to cyan color tones
G-B	Magenta to blue and green to yellow color tones
B-R	Yellow to red, blue to cyan color tones
B-G	Yellow to green and blue to magenta color tones

Image Quality Settings

Setting the image quality.

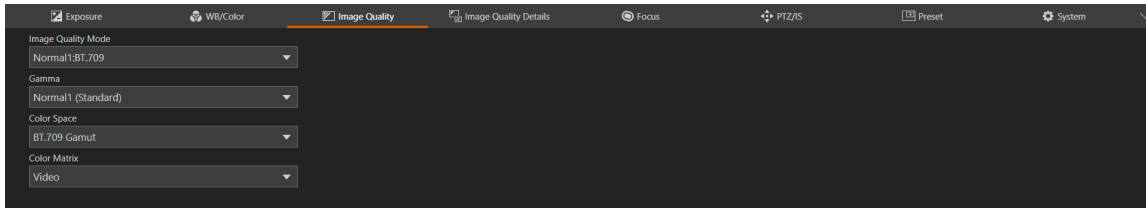

Note

When [Exposure] > [Shooting Mode] is (Portrait), (Sports), (Low Light), or (Spotlight), the [Image Quality] tab cannot be selected. **N300**

[Image Quality Mode] **N500**

Presets that combine gamma, color space, and color matrix are provided as image quality modes.

The Image Quality Mode settings are as follows:

Image Quality Mode	Gamma	Color Space	Color Matrix	Features
Normal 1:BT.709	Normal 1 (Standard)	BT.709	Video	Appropriate settings for viewing on a TV monitor
Normal 1:BT.2020	Normal 1 (Standard)	BT.2020	Video	
Wide DR:BT.709	Wide DR	BT.709	Video	Appropriate settings for viewing on a TV monitor Realizing wide dynamic range
Wide DR:BT.2020	Wide DR	BT.2020	Video	
Canon Log3: BT.709	Canon Log3	BT.709	Neutral	Uses Canon Log3 gamma for post-production processing
Canon Log3: BT.2020	Canon Log3	BT.2020	Neutral	

The image quality mode of the BT.2020 color space is for HDMI/SDI output.

When Image Quality Mode is [Custom], it is possible to select gamma, color space, and color matrix separately.

[Gamma]

Select the gamma curve that determines the overall taste of the image.

[Normal 1 (Standard)]

Use when watching on a TV monitor.

[Normal 2 (x4.0)] **N500**

Able to express the high brightness areas brighter compared to Normal 1.

[Normal 3 (BT.709)]

Able to express black gradation in the shadow areas more compared to Normal 2. **N500**

Able to express black gradation in the shadow areas more compared to Normal 1. **N300**

[Normal 4 (x5.0)] **N500**

Able to express black gradation in the shadow areas more compared to Normal 3.

[Wide DR] **N500**

Ensures a wide dynamic range. Used to output to a TV monitor.

[Canon Log3] **N500**

Gamma for postproduction processing.

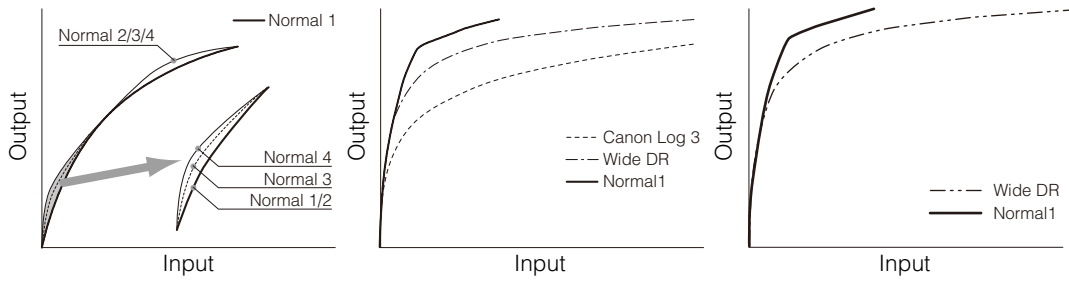

Note

Canon Log3 provides a wide dynamic range that maximizes the characteristics of the image sensor. **N500**

[Color Space]

Select a color space.

[BT.2020 Gamut]

A color space that conforms to the ITU-R BT. 2020 standard specified for UHDTV (4K/8K). This is the setting for HDMI/SDI output.

[BT.709 Gamut]

A standard color space that conforms to the sRGB standard.

[Color Matrix]

Select the video's image tone.

[Video]

Realizes color reproduction with contrast suitable for TV broadcasting.

[Neutral]

Faithful color reproduction.

Image Quality Details Settings

Detailed settings related to image quality.

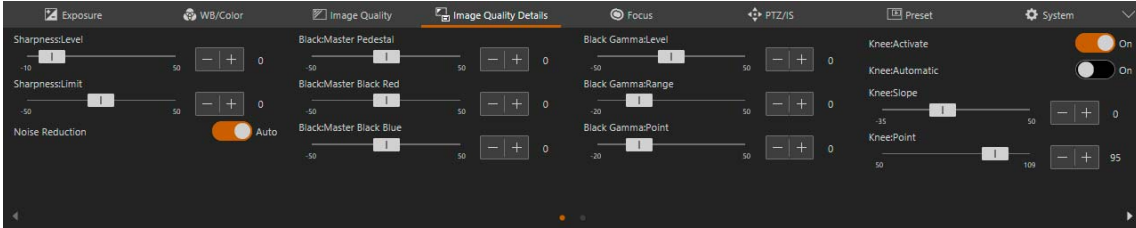

Note

When [Exposure] > [Shooting Mode] is (Portrait), (Sports), (Low Light), or (Spotlight), the [Image Quality Details] tab cannot be selected. **N300**

[Sharpness:Level]

Adjust the level of edge enhancement.

[Sharpness:Limit]

Adjusts the level at which the edge enhancement is limited.

[Noise Reduction]

Selects setting method of noise filter to reduce noise.

When [Auto] is turned on, the noise reduction level is automatically set.

When [Auto] is turned off, it is possible to adjust the noise reduction level manually. The higher the value, the greater the noise reduction effect.

[Black:Master Pedestal]

Adjusts the black level.

The higher the value, the vivid the dark area will be and less contrast. Decreasing the number makes the black levels flat. When [Image Quality] > [Gamma] is set to [Canon Log3], it will not be displayed. **N500**

[Black:Master Black Red], [Black:Master Black Blue]

Corrects R and B individually for black color casts.

When [Image Quality] > [Gamma] is set to [Canon Log3], it will not be displayed. **N500**

[Black Gamma:Level], [Black Gamma:Range], [Black Gamma:Point]

Corrects gamma in shadow areas. By changing each value, the gamma curve on the black side within the range shown in the figure below is adjusted.

- Level: Height from reference gamma
- Range: Width from the point
- Point: Vertex position

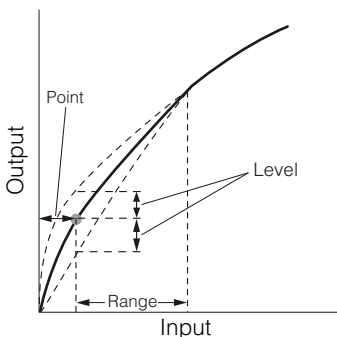

This function will not be displayed when [Image Quality] > [Gamma] is set to [Wide DR] or [Canon Log3]. **N500**

[Knee:Activate], [Knee:Automatic], [Knee:Slope], [Knee:Point], [Knee:Saturation]

Compresses the highlighted areas to suppress the occurrence of blown highlights.

- Activate: Enables knee adjustment.
- Automatic: Enables automatic knee adjustment.
- Slope: Indicates the slope of the knee.
- Point: Indicates the knee point.

- Saturation: Adjusts the color intensity in the highlighted areas.

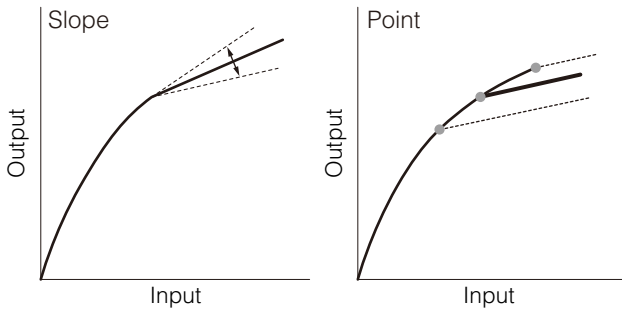

This function will not be displayed when [Image Quality] > [Gamma] is set to [Wide DR] or [Canon Log3]. **N500**

Focus Settings (CR-N500)

There are two focus adjustment modes: "Autofocus" and "Manual focus".

Switch the [AF] on in the focus mode to select the autofocus or switch it to off to select the manual focus.

The items that can be set differ depending on the focus mode.

Autofocus

Autofocus adjusts the focus automatically.

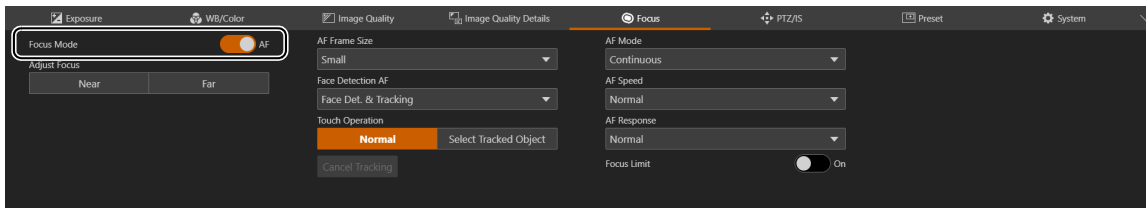

[Focus Mode]

Turning [AF] on switches to autofocus mode.

[Adjust Focus]

Able to adjust the focus manually even when [AF] is set to on.

Click [Near] to move the focus position to the near side, and [Far] to move the focus position to the far side. Click and hold the button to move continuously. Release the button to return to auto focus.

[AF Frame Size]

Able to change the size and position of the AF frame displayed on the screen when adjusting with autofocus.

When the AF frame size is set to [Big] or [Small], selecting the position of the AF frame is possible. During face detection or subject tracking, the size and position of the AF frame automatically changes to match the face and subject (P. 38).

[Auto]

Focuses on the subject in the center of the screen. No frame is displayed.

[Small], [Big]

Focuses on the subject in the AF frame shown. Able to move the AF frame to any position within 80% of the screen (P. 38).

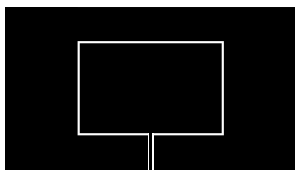

AF frame

[Face Detection AF]

Sets the operation of the face detection AF (the ability to detect and focus on a person's face).

[Off]

Focuses on the AF frame or the center of the screen. Face detection is not performed.

[Face Det. & Tracking]

Gives priority to focus on a person's face.

- When there is a person's face in the screen
When multiple people are in the screen, the main subject is automatically determined.
The following face frame is displayed regardless of the [AF Frame Size] setting.

Frame representing the main face (if even one face)

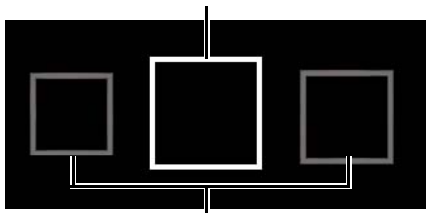

Frame representing a non-main face

Click on a face frame to track that face (P. 38).

- When there is no face in the screen
The [AF Frame Size] setting determines the focus position (P. 38).

[Face Only]

Focuses only on the person's face.

If there is a person's face in the screen, follows the procedure described in the previous section, [Face Det. & Tracking].

If there isn't any person's face in the screen, the focus is locked until a face is detected.

[Touch Operation]

For screen operations, refer to "Clicking on the Screen" (P. 38).

[Cancel Tracking]

Cancels tracking when tracking a specified subject (P. 38).

[AF Mode]

Selects the autofocus mode.

[Continuous]

Always on autofocus.

[AF-Boosted MF]

Click [Near] or [Far] to roughly adjust the focus of the target subject, and it will automatically adjust the focus when the subject approaches the in-focus position.

Use this mode when the video size is large, such as [3840 x 2160], or when wanting to prevent the focus from becoming less precise during shooting. In addition, since an uncertain adjustment operation is not performed when adjustment information cannot be detected, adjustment can be performed more stably than [Continuous].

[AF Speed]

Selects the autofocus adjustment speed. The setting values are High, Normal, and Low in order of speed.

[AF Response]

Selects the responsiveness of the autofocus.

The setting values are High, Normal, and Low in order of the shortest time until the focus operation starts.

[Focus Limit]

Reduces the time to achieve the focus by limiting the focus range.

When set to [On], the focus range is limited to 60 cm (2 ft.) to ∞ (throughout the entire zoom range). When set to off, the range is 1 cm (0.39 in.; at full wide-angle) to ∞ , including the macro area.

■ Clicking on the Screen

Click the screen to move the AF frame to that position. Even if a person or subject moves in the screen, it is possible to keep the focus on the main subject. This is called tracking.

When [Face Detection AF] is [Off]

If [AF Frame Size] is [Big] or [Small], the AF frame moves to the point where clicked.

When [AF Frame Size] is set to [Auto], the subject in the center of the screen stays in focus and the AF frame will not be displayed.

When [Face Detection AF] is [Face Det. & Tracking]

When clicking on a person's face, a tracking frame appears on the face, and the tracking will be in progress.

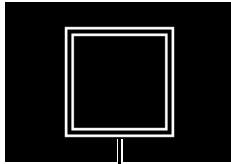

Tracking Frame

If something other than the face of a person is clicked, depending on the AF frame size, the operation differs as follows.

When [AF Frame Size] is set to [Auto], the tracking frame appears on the subject clicked on the screen and is tracked.

If [AF Frame Size] is set to [Big] or [Small], and [Touch Operation] is set to [Normal], when there is no person's face, the AF frame appears where it was clicked. If there is a person's face in the screen, the face frame remains displayed.

When [AF Frame Size] is set to [Big] or [Small] and [Touch Operation] is set to [Select Tracked Object], a tracking frame is displayed on the subject clicked on the screen and is tracked.



Note

When the tracking frame is displayed, the face frame will not be displayed.

When [Face Only] is selected for [Face Detection AF]

Clicking a person's face is the same as in [Face Det. & Tracking] in the previous section.

If something other than a person's face is clicked, the focus does not change.

Autofocus

- The focus position for autofocus varies slightly depending on the shooting conditions such as the subject, brightness, and zoom position. Check the focus again before shooting.
- Focus adjustment can take a while when the frame frequency is 29.97 Hz, 25.00 Hz, or 23.98 Hz.
- It may be difficult to focus with autofocus in certain cases.

Shooting conditions that are difficult to focus with autofocus



Strong light is reflected.



Center of the screen has little light/dark difference.

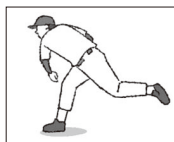

Fast movement

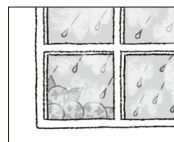

Shooting through glass with water droplets



Night view



Repeated pattern

- When [Image Quality] > [Gamma] is set to [Canon Log3] or [Wide DR]
- When the iris is narrowed down
- When the shutter speed is in the range of [Slow (sec.)]
- When subjects are at both far and near sides
- The following are the main examples of failure to detect faces:
 - When the face is extremely small, large, dark, or bright relative to the entire screen
 - When the face is facing sideways or diagonally, or the face is upside down
 - When part of the face is hidden
- May detect a subject other than a person as a face by mistake. If so, set [Face Detection AF] to [Off].
- May accidentally track another subject with similar characteristics. In this case, select the subject again.
- The conditions under which face detection AF or tracking cannot be used are as follows:
 - Shutter speed slower than 1/30 of a second (frame frequency at 59.94/29.97 Hz), 1/25 of a second (at 50.00/25.00 Hz), or 1/24 of a second (at 23.98 Hz).
 - When [PTZ/IS] > [Digital Zoom] is set to [300x] and the image size is magnified by more than 60 times
 - [PTZ/IS] > [Digital Zoom] > [Digital Tele-Converter] to [6.0x]
- Unable to change the size or position of the AF frame in the following cases: Also, the [AF mode], [AF Speed], and [AF response] settings are disabled.

- When [PTZ/IS] > [Digital Zoom] is set to [300x] and the zoom position is the digital zoom area.
- When [PTZ/IS] > [Digital Zoom] > [Digital Tele-Converter] is set to [3.0x] or [6.0x]
- When [AF frame size] is [AUTO], [AF mode] becomes [Continuous].

Manual Focus

Manual Focus makes the focus position move manually.

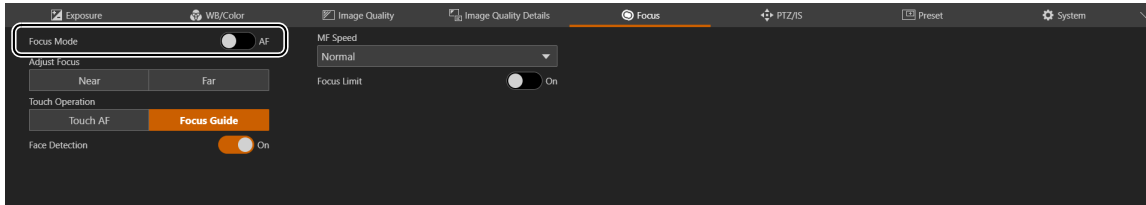

Note

- If a zoom operation is performed after focusing, the focus may shift.
- If the camera is left turned on, the focus may shift due to increase of the temperature of the lens and inside the camera body. Check the focus again before shooting.

[Focus Mode]

Turning [AF] off switches to manual focus mode.

[Adjust Focus]

Click [Near] to move the focus position to the near side, and [Far] to move the focus position to the far side. Click and hold the button to move continuously.

[MF Speed]

Selects the manual focus adjustment speed (amount of focus movement when [Near] or [Far] is clicked.).

[Touch Operation]

Specifies the action when clicking the video.

[Touch AF]

Focuses on the position clicked on the screen.

[Focus Guide]

The focus guide frame is displayed and is able to move the frame to the position clicked on the screen.

The focus guide frame visually displays the direction and amount of adjustment from the current focus position to the in-focus position.

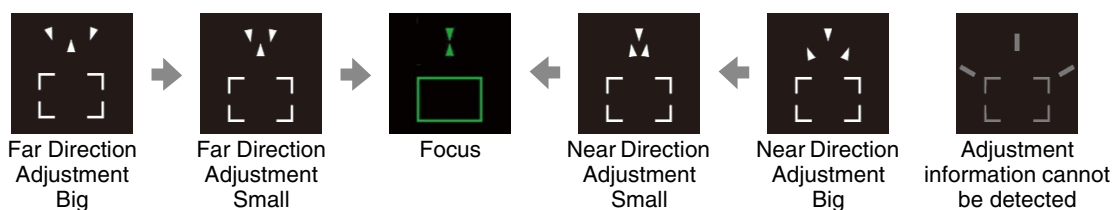

[Face Detection]

Displayed when [Focus Guide] is set by [Touch Operation].

When set to [On], if there are people's faces on the screen, the focus guide frame will be displayed around the eye of the person judged to be the main subject.

When turned off or no faces in the screen, the focus guide frame can be moved to the clicked position.

Note

- The green focus guide indicates the focus range.
- When the [Iris (Aperture Value)] is set to [Auto], it may take a while for the response of the focus guide frame to stabilize after a zoom operation.
- In the "Shooting conditions that are difficult to focus with autofocus" (P. 39), the focus guide frame may not be displayed correctly.
- The focus guide is not available if:
 - [PTZ/IS] > [Digital Zoom] is set to [300x] and the zoom position is the digital zoom area.

- [PTZ/IS] > [Digital Zoom] > [Digital Tele-Converter] is set to [3.0x] or [6.0x]
- The face detection is not available if:
 - Shutter speed slower than 1/30 of a second (frame frequency at 59.94/29.97 Hz), 1/25 of a second (at 50.00/25.00 Hz), or 1/24 of a second (at 23.98 Hz).

[Focus Limit]

The setting is the same as for "Autofocus" (P. 37).

Focus Settings (CR-N300)

There are two focus adjustment modes: "Autofocus" and "Manual focus".

Switch the [AF] on in the focus mode to select the autofocus or switch it to off to select the manual focus.

The items that can be set differ depending on the focus mode.

Autofocus

Autofocus adjusts the focus automatically.

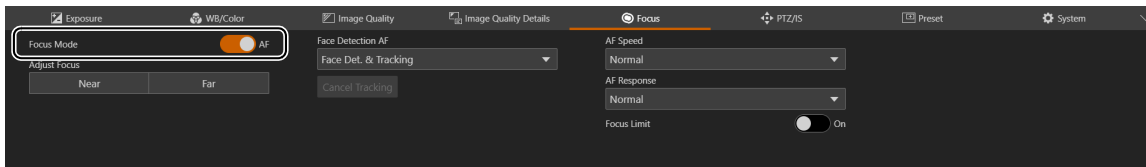

[Focus Mode]

Turning [AF] on switches to autofocus mode.

[Adjust Focus]

Able to adjust the focus manually even when [AF] is set to on.

Click [Near] to move the focus position to the near side, and [Far] to move the focus position to the far side. Click and hold the button to move continuously. Release the button to return to auto focus.

[Face Detection AF]

Sets the operation of the face detection AF (the ability to detect and focus on a person's face).

[Off]

Focuses on the center of the screen. Face detection is not performed.

[Face Det. & Tracking]

Gives priority to focus on a person's face.

- When there is a person's face in the screen
When multiple people are in the screen, the main subject is automatically determined.
The following face frame is displayed.

Frame representing the main face (if even one face)

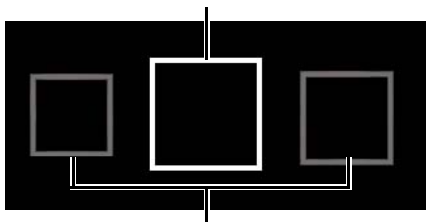

Frame representing a non-main face

Click on a face frame to track that face (P. 43).

- When there is no face in the screen
Focuses on the center of the screen (P. 43).

[Face Only]

Focuses only on the person's face.

If there is a person's face in the screen, follows the procedure described in the previous section, [Face Det. & Tracking].

If there isn't any person's face in the screen, the focus is locked until a face is detected.

[Cancel Tracking]

Cancels tracking when tracking a specified subject (P. 43).

[AF Speed]

Selects the autofocus adjustment speed.

[High]

Operates AF at the fastest speed. Effective for high brightness or night view. Uses the external sensor at the same time.

[Normal]

Operates more smoothly compared to [High]. Uses the external sensor at the same time.

[Low]

Stable AF operation.

[AF Response]

Selects the responsiveness of the autofocus.

The setting values are High, Normal, and Low in order of the shortest time until the focus operation starts.

[Focus Limit]

Reduces the time to achieve the focus by limiting the focus range.

When set to [On], the focus range is limited to 60 cm (2 ft.) to ∞ (throughout the entire zoom range). When set to off, the range is 1 cm (0.39 in.; at full wide-angle) to ∞ , including the macro area.

■ Clicking on the Screen

By clicking on the person or on the subject in the screen, even if the subject moves, it is possible to continue to focus on as the main subject. This is called tracking.

When [Face Detection AF] is [Off]

The subject in the center of the screen stays in focus and the AF frame will not be displayed.

When [Face Detection AF] is [Face Det. & Tracking]

When clicking on a person's face, a tracking frame appears on the face, and the tracking will be in progress.

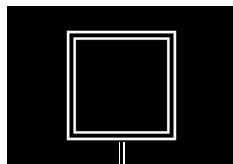

Tracking Frame

If something other than the face of a person is clicked, the tracking frame appears on the subject clicked in the screen and is tracked.



Note

When the tracking frame is displayed, the face frame will not be displayed.

When [Face Only] is selected for [Face Detection AF]

Clicking a person's face is the same as in [Face Det. & Tracking] in the previous section.

If something other than a person's face is clicked, the focus does not change.

■ Autofocus

- The focus position for autofocus varies slightly depending on the shooting conditions such as the subject, brightness, and zoom position. Check the focus again before shooting.
- Focus adjustment can take a while when the frame frequency is 29.97 Hz, 25.00 Hz, or 23.98 Hz.
- It may be difficult to focus with autofocus in certain cases.

Shooting conditions that are difficult to focus with autofocus

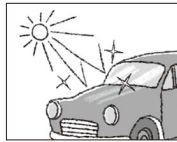

Strong light is reflected.

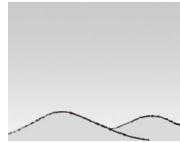

Center of the screen has little light/dark difference.

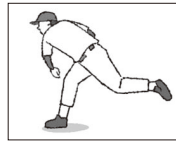

Fast movement

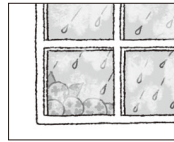

Shooting through glass with water droplets



Night view

- When the iris is narrowed down
- When the shutter speed is in the range of [Slow (sec.)]
- When subjects are at both far and near sides
- The following are the main examples of failure to detect faces:
 - When the face is extremely small, large, dark, or bright relative to the entire screen
 - When the face is facing sideways or diagonally, or the face is upside down
 - When part of the face is hidden
- May detect a subject other than a person as a face by mistake. If so, set [Face Detection AF] to [Off].
- May accidentally track another subject with similar characteristics. In this case, select the subject again.
- The conditions under which face detection AF or tracking cannot be used are as follows:
 - Shutter speed slower than 1/30 of a second (frame frequency at 59.94/29.97 Hz), 1/25 of a second (at 50.00/25.00 Hz), or 1/24 of a second (at 23.98 Hz).
 - When [PTZ/IS] > [Digital Zoom] is set to [400x] and the image size is magnified by more than 80 times
 - [PTZ/IS] > [Digital Zoom] > [Digital Tele-Converter] to [6.0x]

Manual Focus

Manual Focus makes the focus position move manually.

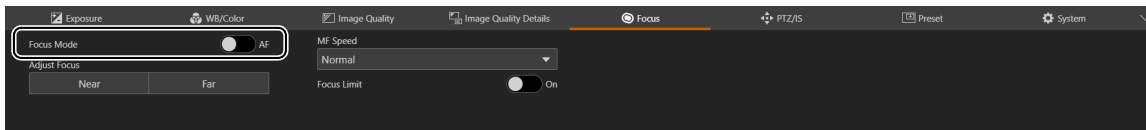

Note

- If a zoom operation is performed after focusing, the focus may shift.
- If the camera is left turned on, the focus may shift due to increase of the temperature of the lens and inside the camera body. Check the focus again before shooting.

[Focus Mode]

Turning [AF] off switches to manual focus mode.

[Adjust Focus]

Click [Near] to move the focus position to the near side, and [Far] to move the focus position to the far side. Click and hold the button to move continuously.

[MF Speed]

Selects the manual focus adjustment speed (amount of focus movement when [Near] or [Far] is clicked.).

[Focus Limit]

The setting is the same as for "Autofocus" (P. 42).

PTZ/IS Settings

Settings for the camera's pan, tilt, and zoom operations and image stabilizer.

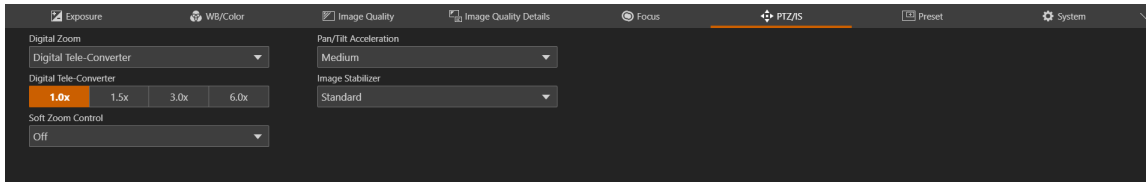

[Digital Zoom]

Select whether to use a digital zoom (300x **N500**, 400x **N300**), or a Digital Tele-Converter.

[Digital Tele-Converter]

When [Digital Zoom] is set to [Digital Tele-Converter], select the magnification of the focal length. Because the image is processed digitally, the video is coarser over the entire zoom range.

[Soft Zoom Control] **N300**

Slowly accelerates when zooming starts and decelerates when zooming stops.

[Pan/Tilt Acceleration]

Select the degree of acceleration of the pan/tilt operation.

[Image Stabilizer]

Select whether to use a function that reduces the blurring of videos caused by camera vibration.

[Standard] corrects relatively small blurs.

[Powered IS] corrects blurring during telephoto shooting. The closer the zoom is to the telephoto side, the greater the correction effect. It is not suitable for pan or tilt.

Note

- If the blurring is too large, it may not be corrected completely.
- For pan and tilt, the anti-vibration effect is smaller than compared to when not operating.
- Swing back may occur when the pan/tilt stops.

Preset Settings

By registering preset camera settings such as camera angle, exposure, and image quality, it is possible to easily call the presets and execute the settings.

Registering Presets

- 1 Click the [Preset] tab on the settings page
Displays the preset settings.
- 2 Click the preset number field to register, and click [Add] to register.

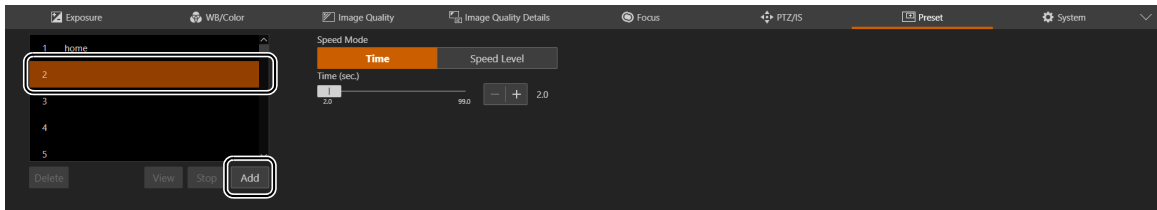

The settings screen will pop up.

- 3 Set the preset items and click [Add]

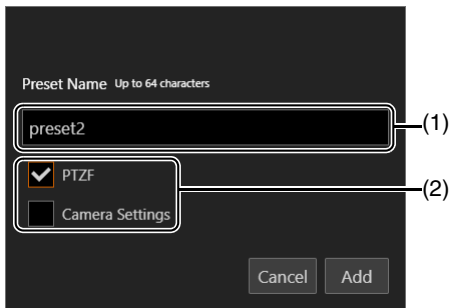

- (1) [Preset Name]
Enter a preset name.
- (2) [PTZF], [Camera Settings]
Check the items to preset.

Item	Preset target
PTZF	Pan/Tilt/Zoom position [Focus] [PTZ/IS] > [Digital Zoom], [Soft Zoom Control] N300 , [Pan/Tilt Acceleration]
Camera Settings	[Exposure] [WB/Color] [Image Quality] [Image Quality Details] [PTZ/IS] > [Image Stabilizer]

The preset is saved to the camera and displayed in the list as follows:

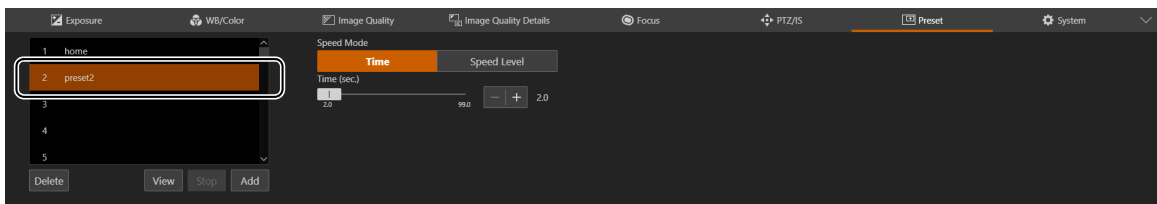

4 Repeat steps 2 to 3 to register multiple presets.



Note

- [home] is the setting when the camera was launched (home position). It can be overwritten but cannot be deleted.
- Able to register up to 100 presets (including home position) in the camera.

Calling Presets

Select the preset to call from the list and click [View] to reflect the preset settings on the camera.

Confirm in the video display area.

The time or speed at which the camera moves to the pan/tilt/zoom position can be specified in the [Speed Mode]. Click [Time] or [Speed Level] and adjust the value with the slider, and then click [View].



Note

- If the pan/tilt/zoom or focus of the camera is operated while a preset is running, the preset stops. However, another preset can be called while a preset is running.
- If [Stop] is clicked while a preset is running on a camera, the preset stops.
- Depending on the relationship between the pan/tilt/zoom position before the call and the registered pan/tilt/zoom position, and the [Time] setting, it may not operate within the set time.
- Camera settings other than the pan/tilt/zoom position are reflected immediately when [View] is clicked.

Deleting Presets

Select the preset to delete from the list and click [Delete] to delete it from the camera.

System Settings

Configure advanced camera system settings such as video and audio, server, communications, and security. If selecting the [System] tab in settings, the video display/operation area disappears and the following appears.

Screen Configuration

When [System] tab is clicked, the setting items category is displayed on the left side of the screen, and the setting screen is displayed on the right side.

Categories of the setting items can also be displayed by clicking the  at the upper right of the screen.

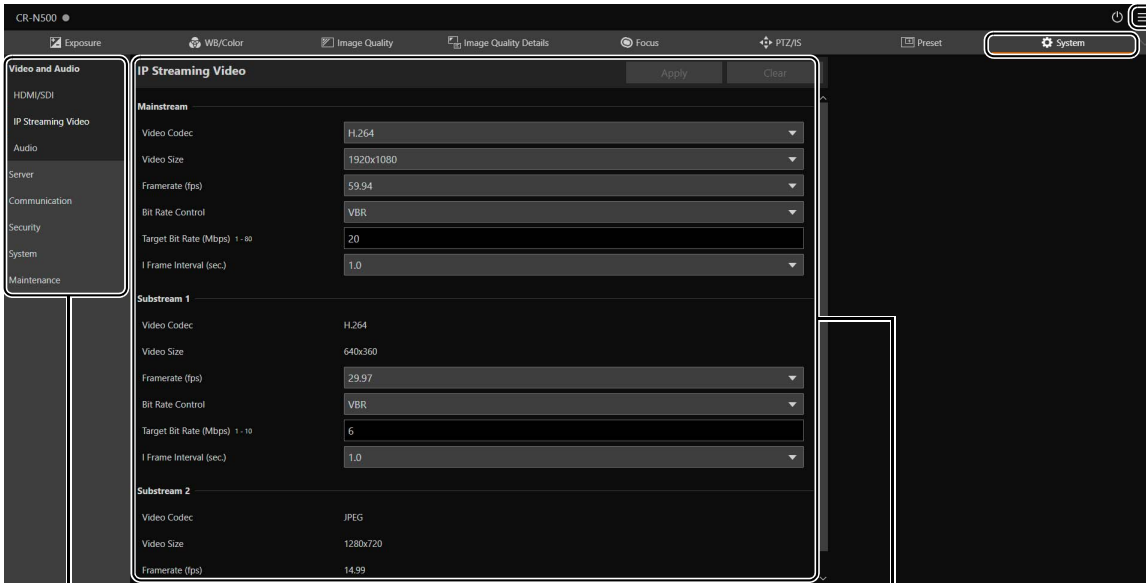

Setting items category

Settings screen

If the width of the screen is narrow, operations must be made from the  menu since the categories of the setting items are hidden.

Setting Items

The system setting items are summarized as follows:

Category	Item	Description
Video and audio	HDMI/SDI	Setting the common output signal method for HDMI/SDI and 3G-SDI mapping (P. 51)
	IP Streaming Video	General settings of the video, such as video size and quality sent from the camera (P. 52)
	Audio	Setting the bit rate for audio input from a microphone connected to the camera or IP audio streaming (P. 54)
Server	HTTP/Video	Setting the HTTP Server and video server (P. 56)
	RTP	Communication setting using RTP Server (P. 57)
Communication	Network	Setting the network to which the camera is connected (P. 59).
	Wireless LAN	Setting the access point or IPv4 settings (P. 62) for direct connection of the camera and Wireless LAN enabled device.
	External Connection (IP)	Setting the communication protocol for IP connection of the camera with external devices such as controllers (P. 64).
	External Connection (serial)	Settings for serial connection of the camera (P. 68)
Security	Certificate Management	Settings for certificate creation and management (P. 70).
	SSL/TLS	Encrypted communications and server certificate settings (P. 71).
	User Management	Add/delete and set operating privileges for administrator account information and authorized users (P. 72).
	Host Access Restrictions	Setting separate access controls for access from IPv4 and IPv6 addresses (P. 74).
System	Camera	Camera Name and camera Installation Conditions, Tally Lamp, IR remote controller, and Genlock settings (P. 76).
	Date and Time	Camera date and time settings (P. 78).
	Environment	Frame frequency settings (P. 80).
	Language	Display language settings (P. 81).
Maintenance	General	Device information and settings, license verification, reboot and initialization settings (P. 82).
	Backup/Restore	Perform backup and restoration (P. 84).
	Update Firmware	Perform firmware update (P. 85).
	Log	Log display and downloading message (P. 86).

Common Operations

Describes common operations in system settings.

Note

If a setting that does not display a dialog in a web browser is enabled, it may not be possible to operate the Settings Page. In this case, close and restart the web browser.

■ Applying Configuration Changes

When a setting is changed on the Settings Page, the [Apply] and [Clear] buttons in the upper right of the Settings Page are no longer grayed out and can be clicked.



In this situation, if [Apply] is clicked, the changed settings will be applied. Click [Clear] to revert to the previous settings.

■ Changes to Settings that Require to Reboot

Settings that require the camera to be restarted for the changed settings to take effect are indicated with a green [Reboot] symbol in the beginning.



When an item that has a [Reboot] symbol is changed, [Apply] in the upper right of the Settings Page changes to [Apply and Reboot].

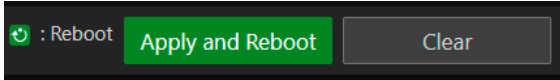

Click [Apply and Reboot] to apply the changes and restart the camera.
Click [Clear] to revert to the previous settings.



Important

If switched to another settings screen without clicking [Apply] or [Apply and Reboot], changes will be lost. Be sure to click [Apply] or [Apply and Reboot] to apply changes.

■ Setting Range and Character Limit

For setting items for numeric values and characters, the allowable range and character limit are displayed.
Enter within the displayed ranges.

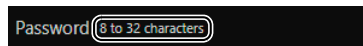

[System] > [Video and Audio] > [HDMI/SDI]

Settings for the output signal format of the HDMI and SDI terminals.

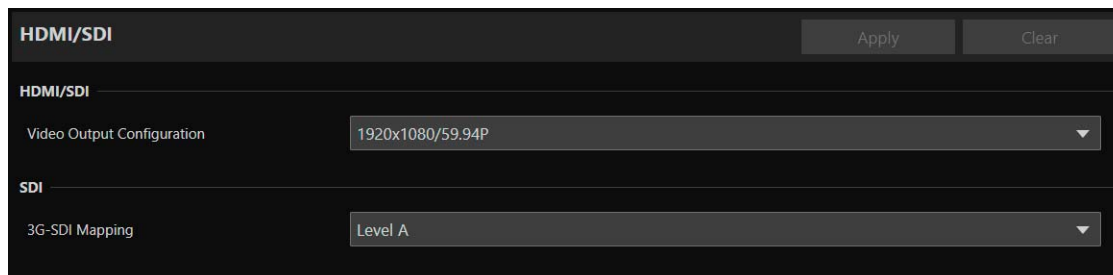

HDMI/SDI Apply Clear

HDMI/SDI

Video Output Configuration: 1920x1080/59.94P

SDI

3G-SDI Mapping: Level A

HDMI/SDI

Common settings for the video output signal format for HDMI/SDI.

[Video Output Configuration]

The video output format is set as a combination of the video size and frame rate.

The selectable HDMI/SDI video output format varies depending on the [Frame Frequency (Hz)] set in [System] > [System] > [Environment].

[Frame Frequency (Hz)]	HDMI/SDI video output format (video size/frame rate)
23.98	1920x1080/23.98P, 3840x2160/23.98P
29.97	1920x1080/29.97P, 3840x2160/29.97P
59.94	1280x720/59.94P, 1920x1080/59.94P, 1920x1080/59.94i
25.00	1920x1080/25.00P, 3840x2160/25.00P
50.00	1920x720/50.00P, 1920x1080/50.00P, 1920x1080/50.00i

The settings and options for each video stream vary depending on the selected video output format. See [System] > [Video and Audio] > [IP Streaming Video] for more information.

Note

SDI output is not available when the video size is 3840 x 2160.

SDI

Settings for the output signal method of the SDI terminals.

[3G-SDI Mapping]

When [Video Output Configuration] is [1920x1080/59.94P] or [1920x1080/50.00P], select the mapping method of the output signal of the SDI terminal. A signal conforming to Level A or Level B of the SMPTE ST 425-1 standard is outputted.

[System] > [Video and Audio] > [IP Streaming Video]

Settings for the general video settings such as size and quality for the video to be distributed via IP. Settings are made for each of the following three streams.

- Mainstream
- Substream 1
- Substream 2

Stream	Video Codec	Video Size	Framerate (fps)	Bit Rate Control	Target Bit Rate (Mbps)	I Frame Interval (sec.)
Mainstream	H.264	1920x1080	59.94	VBR	20	1.0
Substream 1	H.264	640x360	29.97	VBR	6	1.0
Substream 2	JPEG	1280x720	14.99			

The options for [Video Size] and [Framerate (fps)] that can be selected for each video stream vary depending on the frame frequency set in [System] > [System] > [Environment].

Mainstream

Set the Mainstream video to be distributed from the camera.

[Video Codec]

Select the video codec type.

In the following cases, the video codec is H.264.

- If [System] > [Communication] > [External Connection (IP)] > [NDI|HX] is [Enable],
- If [System] > [Communication] > [External Connection (IP)] > [RTMP] is [Enable],

Note

If [I Frame Interval (sec.)] is set to [ALL-I], [H.265] cannot be set.

[Video Size]

Select a video size.

When the frame frequency is 59.94 Hz or 50.00 Hz, [3840 x 2160] cannot be set.

[Framerate (fps)]

Select the frame rate of the video.

[Bit Rate Control]

Settings for the video bit rate.

In order to control the bit rate strictly in an environment subject to limitations such as the bandwidth, set to [CBR].

[Target Bit Rate (Mbps)]

Enter the target value of the bit rate when [Bit Rate Control] is set to [CBR].

Enter a bit rate as an image quality target when [Bit Rate Control] is set to [VBR]. Depending on the video, the set bit rate may be exceeded.

The maximum value that can be entered differs depending on the settings of [Video Size] and [Framerate (fps)].

[I Frame Interval (sec.)]

Select the interval in seconds to insert an I frame into the video selected in [Video Codec]. Specify [ALL-I] if wanting all frames to be I-frames.



Note

When [Video Codec] is set to [H.265], [ALL-I] cannot be set.

Substream 1

Settings for the video of Substream 1 to be distributed from the camera.

[Video Codec]

H. 264 is fixed.

[Video Size]

640 x 360 is fixed.

[Framerate (fps)], [Bit Rate Control], [Target Bit Rate (Mbps)], [I Frame Interval (sec.)]

Refer to each item of [Mainstream].



Note

[Framerate (fps)] of Substream 1 cannot be set to [59.94] or [50.00].

Substream 2

Settings for the video of Substream 2 to be distributed from the camera.

[Video Codec]

JPEG is fixed.

[Video Size]

1280 x 720 is fixed.

[Framerate (fps)]

The set value is displayed according to the frame frequency.

[System] > [Video and Audio] > [Audio]

Settings for the audio input from the microphone connected to the camera and for the bit rate for IP audio streaming.

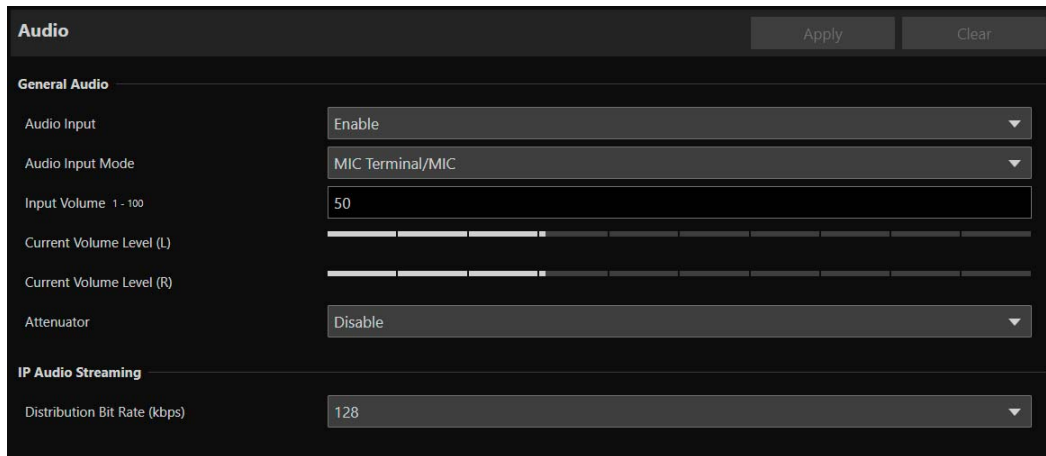

General Audio

Settings for the volume of the audio input and the type of microphone.

[Audio Input]

Select whether to use audio from the microphone.

When [Disable] is selected, Audio cannot be outputted from HDMI/SDI output.

Note

To set [Audio Input] to [Disable], all of the following settings must be changed to [Disable].

- [System] > [Server] > [RTP Server] > Each stream (Main, Sub1, Sub2) > [Audio Transmission]
- [System] > [Communication] > [External Connection (IP)] > [NDI|HX] > [Audio Transmission]
- [System] > [Communication] > [External Connection (IP)] > [RTMP] > [Audio Stream]
- [System] > [Communication] > [External Connection (IP)] > [SRT] > [Audio Stream]

[Audio Input Mode]

Select the type of microphone to connect to the camera: input terminals (INPUT **N500**/MIC), input method (LINE/MIC), and with or without power to the microphone.

Setting Value	Input Terminal	Input Method	Power to Microphone
MIC Terminal/LINE	MIC	LINE	-
MIC Terminal/MIC	MIC	MIC	Not Supported
MIC Terminal/MIC (MIC Power On)	MIC	MIC	Supported
INPUT Terminal/LINE N500	INPUT	LINE	-
INPUT Terminal/MIC N500	INPUT	MIC	Not Supported
INPUT Terminal/MIC+48V N500	INPUT	MIC	+48V

Note

To use a microphone that requires phantom powering, turn it on while connected, and then set it to [INPUT Terminal/MIC+48V]. **N500**

Caution

When using a microphone, set [Audio Input Mode] correctly according to the specifications of the microphone.

Failure to do so may damage the camera or microphone.

[Input Volume]

Settings for the volume to be inputted from the microphone connected to the camera.

[Current Volume Level (L)], [Current Volume Level (R)]

Displays the current volume level in the status bar.

[Attenuator]

Select whether to use the attenuator (20 dB) when the MIC input method is selected for [Audio Input Mode].

IP Audio Streaming

Features settings for IP Audio streaming.

[Distribution Bit Rate (kbps)]

Select the bit rate for distribution.



Important

- Video and audio may not be synchronized.
- Depending on the performance of the computer and the network environment, audio may be choppy.
- If using antivirus software, audio may be choppy.
- If communication is temporarily interrupted by reseating of the LAN cable for example, the audio will be disconnected. In this case, reconnect the device to the camera.

[System] > [Server] > [HTTP/Video]

Setting for the HTTP Server for distributing Settings Page and videos over the network, and video distribution via HTTP.

HTTP/Video

Reboot Apply Clear

HTTP Server

Authentication Method Digest Authentication

HTTP Port 80,1024 - 65535 80

HTTPS Port 443,1024 - 65535 443

Video Server

Maximum Number of Clients 0 - 15 15

Maximum Connection Time (sec.) 0 - 65535 0

HTTP Server

Settings for the authentication method and HTTP port.

Important

A confirmation dialog will appear when the [HTTP port] or [HTTPS port] settings are changed, and the connection to the camera from the active web browser may become disabled. If the changed settings are to be applied, click [OK].

If unable to reconnect to the camera from the web browser after restarting the camera, a message appears with a suggested URI, if any, to reconnect to the camera.

If unable to connect to the camera through the displayed URI, contact your system administrator.

[Authentication Method]

Select the authentication method to be used by the HTTP Server.

[HTTP Port]

Enter the HTTP port.

In general, use [80] (factory default setting).

[HTTPS Port]

Enter the HTTPS port.

In general, use [443] (factory default setting).

Video Server

Settings for clients which can connect to the Video Server.

[Maximum Number of Clients]

Enter the maximum number of clients that can connect to the camera simultaneously.

If [0] is entered, only the administrator is allowed to connect.

Important

If there are many clients to distribute, the video frame rate may decrease or the audio may be cut off.

[Maximum Connection Time (sec.)]

Enter the maximum time, in seconds, that individual client can connect to the camera.

If [0], the connection time is unlimited.

[System] > [Server] > [RTP]

Settings for video and audio streaming using RTP.

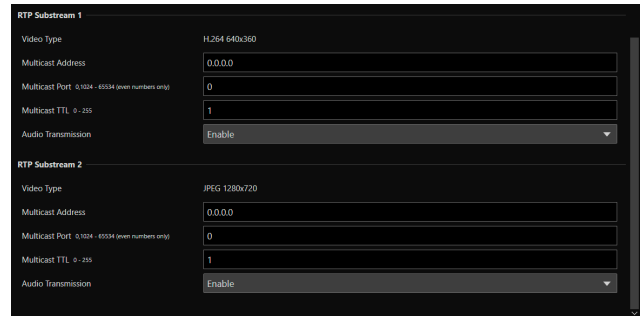
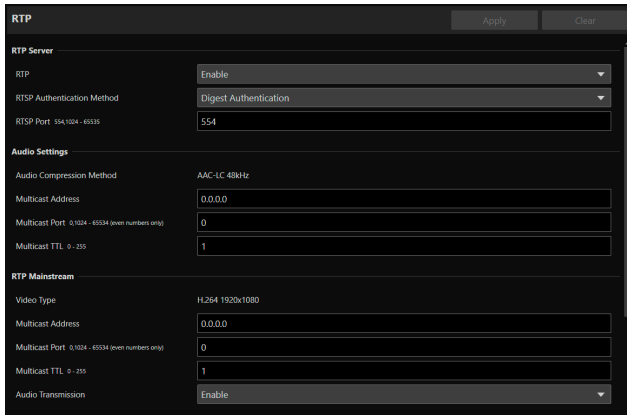

RTP Server

Settings for use of RTP, RTSP authentication method and port number.

[RTP]

Select whether to use RTP.

[RTSP Authentication Method]

Select a RTSP authentication method. Since RTSP authentication method is set independently from HTTP Server authentication method, it is necessary to configure the setting for each authentication method.

[RTSP Port]

Enter the RTSP port.

In general, use [554] (factory default settings).

Audio Settings

Settings for multicast audio transmission.

[Audio Compression Method]

Displays the audio compression method and the frequency. [AAC-LC 48kHz] as fixed value.

[Multicast Address]

Enter multicast address for audio transmission as follows.

IPv4: in the range of 224.0.0.0 to 239.255.255.255

IPv6: address starting with ff00::/8

[Multicast Port]

Enter multicast port for audio transmission.

[Multicast TTL]

Enter the effective range for multicast distribution.

The TTL (Time To Live), representing the effective range for multicast distribution, is decremented each time the signal passes through a router. When it reaches 0, distribution through a router becomes impossible.

For example, if TTL is set to [1], multicast distribution is confined to the local segment only and cannot pass through the router.



Note

With one of the following settings, audio multicast distribution is disabled.

- Set [0.0.0.0] (IPv4) or [::0::] (IPv6) for [Multicast Address] .
- Set [0] for [Multicast Port] or [Multicast TTL].

RTP Mainstream, RTP Substream 1, RTP Substream 2

Settings for RTP stream distribution, to be configured for each stream.

[Video Type]

Displays [Video Codec] and [Video Size] set for each video stream in [System] > [Video and Audio] > [IP Streaming Video].

[Multicast Address]

Enter multicast address for RTP stream as follows.

IPv4: in the range of 224.0.0.0 to 239.255.255.255

IPv6: address starting with ff00::/8

[Multicast Port]

Enter multicast port for RTP stream.

[Multicast TTL]

Enter the effective range for multicast distribution of RTP stream.

The TTL (Time To Live), representing the effective range for multicast distribution, is decremented each time the signal passes through a router. When it reaches 0, distribution through a router becomes impossible.

For example, if TTL is set to [1], multicast distribution is confined to the local segment only and cannot pass through the router.

[Audio Transmission]

Select whether to use the audio transmission of RTP stream.

When [Disable] is set for [System] > [Video and Audio] > [Audio] > [General Audio] > [Audio Input], [Enable] cannot be set.



Note

- With one of the following settings, the multicast distribution of RTP stream is disabled.
 - Set [0.0.0.0] (IPv4) or [::0(::)] (IPv6) for [Multicast Address] .
 - Set [0] for [Multicast Port] or [Multicast TTL].
- URL for RTP stream
rtsp://IP address: port/rtpstream/config1(to 3)
Example: rtsp://192.168.100.1:554/rtpstream/config1
Note: Distribution method depends on the request for distribution from the RTP client application.
 - Distribution method depends on the request for distribution from the RTP client application.
 - config1 requests the distribution of Mainstream, config 2 requests Substream 1, and config 3 requests Substream 2.
- Video quality of [Bit Rate Control] of Main and Sub1 uses the settings in [System] > [Video and Audio] > [IP Streaming Video] (P. 52)
- [Video Distribution] in [System]> [Security]> [User Management]> [User Authority] is not reflected in RTP.
- In an environment using proxy server or firewall, the video from the RTP stream may not be displayed. In such a case, contact your system administrator.
- When the host access restriction is applied to a client during the RTP over UDP stream distribution, it may take from a few seconds to several tens of seconds to stop the distribution.

[System] > [Communication] > [Network]

Settings for connecting to the network.

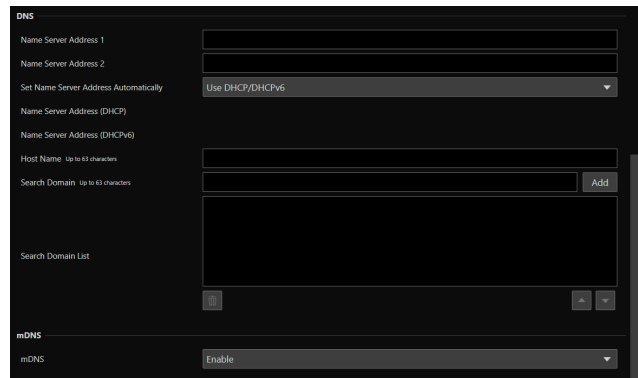
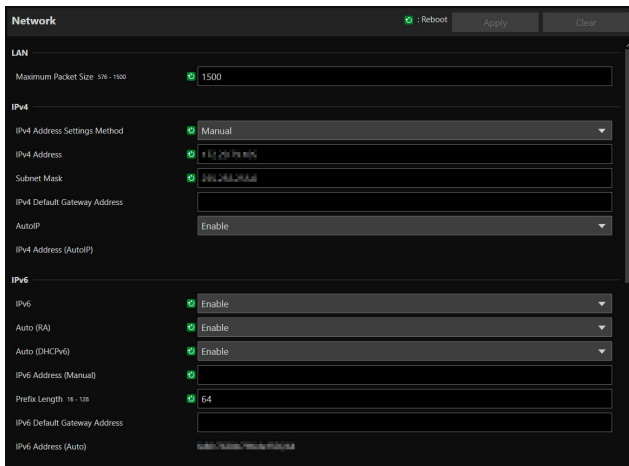

Important

If changing settings related to network connection, it might not be possible to connect to the camera from the web browser. In this case, by clicking [Apply] or [Apply and Reboot], a dialog for confirmation will be displayed. Click [OK] to apply the change. If unable to reconnect to the camera from the web browser after the camera is restarted due to a configuration change, a message appears with a suggested URI, if any to reconnect to the camera. If unable to connect to the camera through the displayed URI, contact the system administrator.

LAN

Settings for the transmission data size from the camera.

[Maximum Packet Size]

Enter the maximum size for the packets transmitted from the camera. In general, it is not necessary to change from 1500. When using IPv6, it is necessary to set 1280 or higher. When using ADSL, by slightly decreasing the value, transmission efficiency may be improved.

IPv4

Settings for connection to the camera by IPv4. IPv4 address can be acquired automatically from the DHCP Server or can be set manually.

Important

- Regarding [IPv4 Address], [Subnet Mask] and [IPv4 Default Gateway Address] for manual setting of IPv4, contact your system administrator.
- If there is any error in the settings of [IPv4 Address], [Subnet Mask] or [IPv4 Default Gateway Address], access via network may not be possible. In such a case, search cameras using the Camera Search Tool, and set the address again.

[IPv4 Address Settings Method]

Select the IPv4 address settings method.

For [Manual], enter a fixed IPv4 address to [IPv4 Address].

For [Auto (DHCP)], a value acquired from DHCP Server will be set automatically to [IPv4 Address (DHCP)] and [IPv4 Default Gateway Address (DHCP)].

Important

When using IPv4 address settings in [Auto (DHCP)], in an environment with a router between the DHCP Server and the camera, IPv4 address may not be assigned correctly. In such a case, select [Manual] to set the fixed IPv4 address.

[IPv4 Address]

When [IPv4 Address Settings Method] is [Manual], enter the fixed IPv4 address.

[Subnet Mask]

When [IPv4 Address Settings Method] is [Manual], enter the subnet mask value specified for each network.

[IPv4 Default Gateway Address]

When [IPv4 Address Settings Method] is [Manual], enter a value. Make sure to set, when connecting the camera to a subnet different from IP connection device such as controller.

[AutoIP]

Select whether to use AutoIP. When the AutoIP address is enabled, IP address automatically set will be displayed in [IPv4 Address (AutoIP)].

IPv6

Settings for connection to the camera using IPv6. IPv6 address can be acquired automatically from the RA or the DHCPv6 Server, or can be set manually.

Important

Regarding [IPv6 Address (Manual)], [Prefix Length] and [IPv6 Default Gateway Address] for manual setting of IPv6, contact your system administrator.

[IPv6]

Select whether to use IPv6,

[Auto (RA)]

Select [Enable], when automatically setting the address using RA (Router Advertisement, network information transmitted automatically from the router).

[Auto (DHCPv6)]

Select [Enable], when automatically setting the address using DHCPv6.

[IPv6 Address (Manual)]

For setting the address manually, enter a fixed IPv6 address.

[Prefix Length]

For setting the address manually, enter a prefix length.

[IPv6 Default Gateway Address]

For setting the address manually, enter a default gateway address. Make sure to set, when connecting the camera to a subnet different from IP connection device such as controller.

[IPv6 Address (Auto)]

When [IPv6] is [Enable] and [Auto (RA)] or [Auto (DHCPv6)] is [Enable], the address automatically acquired will be displayed.

DNS

Settings for the DNS Server address. DNS Server address can be set manually or can be acquired automatically from the DHCP/DHCPv6 Server.

[Name Server Address 1], [Name Server Address 2]

Enter the name server address to be registered. When only one address is to be registered, leave [Name Server Address 2] blank.

Note

If [Name Server Address 1] cannot be used, make access to [Name Server Address 2]. However, it is assumed that [Name Server Address 2] set beforehand.

[Set Name Server Address Automatically]

Select the server for setting automatically the name server address.

When using DHCP, set [IPv4 Address Settings Method] to [Auto (DHCP)] (P. 59).

When using DHCPv6, set [IPv6] to [Enable] and [Auto (DHCPv6)] to [Enable] (P. 60).

[Name Server Address (DHCP)]

When [Set Name Server Address Automatically] is set as [Use DHCP] or [Use DHCP/DHCPv6], the name server address acquired from the DHCP Server will be displayed.

[Name Server Address (DHCPv6)]

When [Set Name Server Address Automatically] is set as [Use DHCPv6] or [Use DHCP/DHCPv6], the name server address acquired from the DHCPv6 Server will be displayed.

[Host Name]

The host name of the camera can be registered with alphanumeric characters to the name server.

[Search Domain]

When adding a domain name to the search domain list, enter the domain name and click [Add].

If a domain name is specified in the search domain list, it will be handled in the form of host name + domain name simply by specifying the host name without the domain name in the specified server such as NTP and RTMP.

[Search Domain List]

Displays a list of domain names added in [Search Domain].

Queries are sent to the DNS Server in order from the top of the list of domain names.

With the ▲ or ▼ button on the right, the order of the domain names can be changed.

Select a domain name and click  to delete the domain name.

mDNS

Settings for use of multicast DNS. When using mDNS, IP address and host name information of the camera is notified to other hosts on the network.

[mDNS]

Select whether to use mDNS.

For using NDI|HX as a communication protocol (P. 64), set [mDNS] to [Enable].

[System] > [Communication] > [Wireless LAN]

Settings for the access point for directly connecting the camera and the wireless LAN supported devices. By setting different IP addresses for the Wireless LAN and the Wired LAN, it possible to choose and use according the purposes.

Wireless LAN 🔄 : Reboot Apply Clear

Interface

Wireless LAN Enable

Access Point

SSID Up to 32 characters xxxxx

Authentication Method WPA2-PSK/WPA3-SAE mix

Password 8 to 63 characters *****

Confirm Password 8 to 63 characters *****

Channel Setting 1

IPv4

IPv4 Address 🟢 192.168.1.1

Subnet Mask 🟢 255.255.255.0

Interface

Settings for use of the wireless LAN.

[Wireless LAN]

Select whether to use the wireless LAN.

Access Point

When [Wireless LAN] is set as [Enable], set the SSID and the authentication method etc., so that the camera functions as the access point.

[SSID]

Enter the network name (SSID). Enter in single-byte alphanumeric characters, numbers, or symbols.

[Authentication Method]

Fixed as WPA2-PSK/WPA3-SAE mix.

[Password]

Enter a password for the access point. Enter in single-byte alphanumeric characters, numbers, or symbols.

[Confirm Password]

Enter the same password as above for confirmation.

[Channel Setting]

When connecting multiple devices at the same frequency, set the channel to avoid radio interference.



Note

If the SSID is changed, it is also required to change the password.

IPv4

Settings of IPv4 for connecting the wireless LAN and the wired LAN at the same time.

[IPv4 Address]

Enter the fixed IPv4 address.

[Subnet Mask]

Enter specified subnet mask value for each network.



Note

The wireless connection must be on a different subnet than the wired LAN. If the specified IP address is in the same subnet as the wired LAN, an error occurs.

[System] > [Communication] > [External Connection (IP)]

Settings for communication for connecting controllers, etc. via IP.

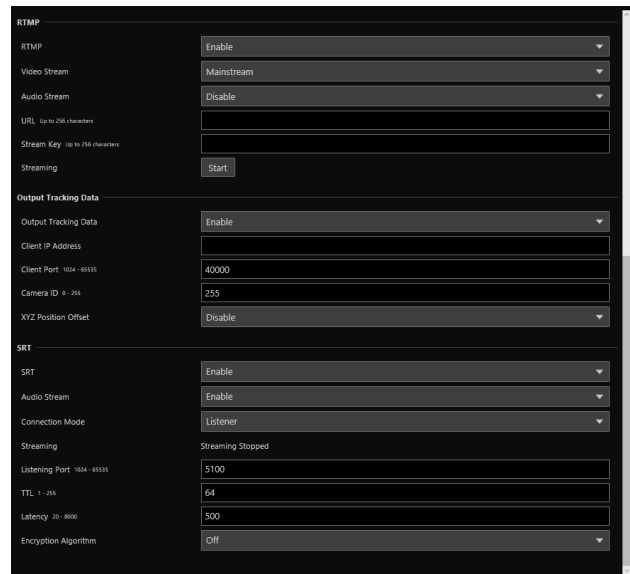
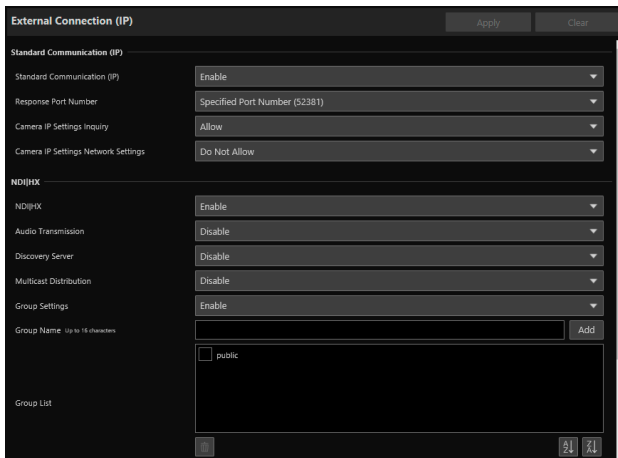

Standard Communication (IP)

Settings for operating the cameras from the controller connected by the standard IP communication.

[Standard Communication (IP)]

Select whether to use [Standard Communication (IP)] for the connection with the controller.

[Response Port Number]

Select whether to use a fixed port number (52381) or a source port number when communicating with the controller.

[Camera IP Settings Inquiry]

Select whether to allow the inquiry on the camera IP settings from the controller.

[Camera IP Settings Network Settings]

Select whether to allow to change the network settings of the camera from the controller.

NDI|HX

Settings for exchanging data with NDI|HX supported devices.

[NDI|HX]

Select whether to use [NDI|HX] as the communication protocol.

For setting to [Enable], go to [System] > [Communication] > [Network] > [mDNS] and select [Enable] (P. 61).

Note

When [System] > [Video and Audio] > [IP Streaming Video] > [Mainstream] > [Video Codec] is set to [H.265], NDI|HX cannot be used.

[Audio Transmission]

Select whether to use the audio transmission.

When [Disable] is set for [System] > [Video and Audio] > [Audio] > [General Audio] > [Audio Input], [Enable] cannot be set.

[Discovery Server]

Select whether to use the Discovery Server.

When set to [Enable], it notifies the Discovery Server only of the IP address and does not notify other hosts of the IP address nor hostname.

[Discovery Server IP Address]

Enter the IP address of the Discovery Server.

[Multicast Distribution]

Select whether to use the multicast distribution.

Note

For multicast distribution, set the multicast distribution enabled in the NDI client side as well.

[Multicast TTL]

Enter the effective range for multicast distribution.

The TTL (Time To Live), representing the effective range for multicast distribution, is decremented each time the signal passes through a router. When it reaches 0, distribution through a router becomes impossible.

For example, if TTL is set to [1], multicast distribution is confined to the local segment only and cannot pass through the router.

[Group Settings]

Select whether to use the group settings.

When a group name to which the camera belongs is specified, the camera connects only to NDI clients with the same group name.

[Group Name], [Group List]

Enter the group name.

By clicking [Add], the entered group name will be displayed in the group list.

Able to sort the list items in ascending order by clicking  and in descending order by clicking .

Select a group in the group list and click  to delete the group.

RTMP

A communication protocol for the streaming playback of video and audio, and sending and receiving the data.

[RTMP]

Select whether to use [RTMP] as the communication protocol.

Note

When [H.265] is set for [System] > [Video and Audio] > [IP Streaming Video] > [Mainstream] > [Video Codec], RTMP cannot be used.

[Video Stream]

Select the type of the video stream. Substream 2 cannot be used.

[Audio Stream]

Select whether to use the audio stream.

When [Disable] is set for [System] > [Video and Audio] > [Audio] > [General Audio] > [Audio Input], [Enable] cannot be set.

[URL]

Enter the URL of the server set on the distribution server side.

Enter the string of characters starting with rtmp:// or rtmps://.

[Stream Key]

Enter the stream key set on the distribution server side.

[Streaming]

By clicking [Start] to start the streaming, the button becomes [Stop].

By clicking [Stop], the streaming ends.

Output Tracking Data

Configures the output of camera tracking data (pan, tilt, zoom, etc.) required when using the virtual studio system in a format compliant with the free-d protocol. The supported message type is Type D1.

[Output Tracking Data]

Select whether to use the camera's Output Tracking Data.

[Client IP Address]

Enter the IP address of the client that will receive the camera tracking data.

[Client Port]

Enter the number of the client port number.

[Camera ID]

Enter the ID that identifies the camera. Be sure to use single-byte numeric characters.

[XYZ Position Offset]

Select whether to specify the camera position.

[X], [Y], [Z]

Enter the value for each.

Note

- About the stored data:

The data to be stored and output are as follows.

Camera ID: Stores the ID set in [Camera ID].

Camera Pan Angle / Camera Tilt Angle / Camera Roll Angle: Stores the camera angles in the format specified by the free-d protocol.

– Pan: -170° to 170°

– Tilt: **N500** -30° to 90°, **N300** -30° to 100°

– Roll: Angle: 0° (fixed)

Camera X-Position / Camera Y-Position / Camera Height (Z-Position) : Stores the value set in [XYZ Position Offset].

Camera Zoom: Stores Zoom type and zoom position.

Camera Focus: Stores the Focus value.

Spare/Undefined Data: Stores the iris value.

Checksum: Stores the Checksum value calculated by the method specified in the free-d protocol.

- If [Genlock] is [Enable], packets are sent along with the genlock signal.

SRT

Configures settings for exchanging data with SRT (Secure Reliable Transport) compliant devices.

[SRT]

Select whether to use [SRT] as the communication protocol.

[Audio Stream]

Select whether to use the audio stream.

Cannot set to [Enable] when [System] > [Video and Audio] > [Audio] > [General Audio] > [Audio Input] is set to [Disable].

[Connection Mode]

Sets the connection mode of the camera. Select [Caller] if you want the camera to connect to an external device, or select [Listener] if you want the camera to listen for connections from an external device.

[Streaming]

If the [Connection Mode] is [Caller], clicking [Start] will start the streaming and the button will be [Stop]. Clicking [Stop] will end the streaming.

[Destination IP Address], [Destination Port]

Enter the IP address/port number of the connected device when [Connection Mode] is [Caller].

[Listening Port]

Enter the port number of the connected device when [Connection Mode] is [Listener].

[TTL]

Enter the TTL (Time To Live) of the packet.

The TTL, which represents the valid range of the packet, is decremented by 1 each time it crosses a router, and when it reaches 0, it cannot be delivered beyond the router. For example, setting the TTL to [1] results in delivery only to a local segment.

[Latency]

Sets the delay time for SRT delivery. Delay time is the time it takes for a lost packet to be recovered. The unit is "ms" (milliseconds).

[Stream ID]

Sets an ID to identify the stream when [Connection Mode] is [Caller]. Be sure to use single-byte alphanumeric characters or symbols.

[Encryption Algorithm]

Select the encryption algorithm (AES-128 / AES-192 / AES-256 / Off).

**Important**

When using encryption, the [Mainstream] > [Target Bit Rate (Mbps)] setting will be restricted.

[Passphrase]

Sets the passphrase to be used for encryption. Be sure to use single-byte alphanumeric characters or symbols. The same passphrase as the connected device must be set.

[System] > [Communication] > [External Connection (Serial)]

Settings for communication by the serial connection of controllers, etc.

External Connection (Serial) Apply Clear

Serial Port

Serial Port: Enable

Serial Port Connection Type: RS422

Baud Rate (bps): 9600

Data Length (bit): 8

Start Bit (bit): 1

Stop Bit (bit): 1

Parity: None

Standard Communication (Serial)

Standard Communication (Serial): Enable

Serial Device Address: Auto

Note

Connect the Remote Camera Controller RC-IP100 via IP. This camera cannot be controlled by the serial connection.

Serial Port

Detail settings for the serial port.

[Serial Port]

Select whether to use the serial port.

[Serial Port Connection Type]

RS-422 as fixed value.

[Baud Rate (bps)]

Select the Baud Rate value.

[Data Length (bit)]

Data length of serial communication is fixed at 8 bit.

[Start Bit (bit)]

The length of the start bit is fixed at 1 bit.

[Stop Bit (bit)]

The length of the stop bit is fixed at 1 bit.

[Parity]

The settings for the error detection code is fixed to None.

Note

In the next item, if the [Standard Communication (Serial)] is set as [Enable], the settings for the baud rate of the serial communication, data length, stop bit, and parity will be changed as follows.

- Baud rate : Speed of Standard Communication (Serial)
- Data length (bit) : 8
- Stop bit (bit) : 1
- Parity : None

Standard Communication (Serial)

Settings for connection with standard serial communication.

[Standard Communication (Serial)]

Select whether to use standard serial communication.

[Serial Device Address]

Select the address of the camera.

When [Auto] is selected, addresses will be automatically assigned.

[System] > [Security] > [Certificate Management]

Manage server certificates. It is also possible to create a self-signed certificate to use, for example, for operation test.

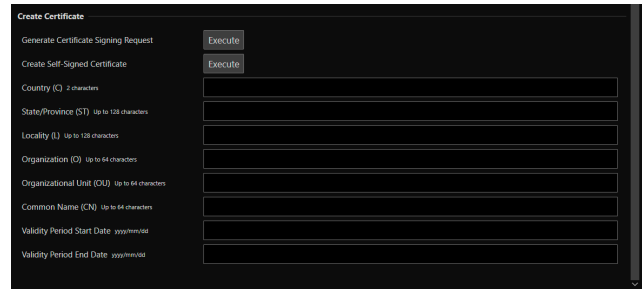
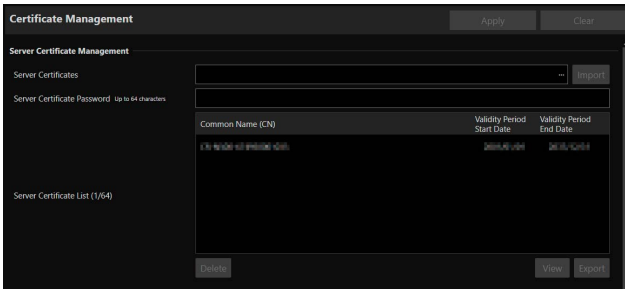

Server Certificate Management

Manage the server certificates.

[Server Certificates]

Perform this operation to import server certificates.

Click [...] and specify the certificate file to be imported, and then click [Import].

[Server Certificate Password]

Set the password to use when importing and exporting the server certificate.

[Server Certificate List]

Click [View] to display the information of server certificates, as a list. Certificate's validity is displayed in GMT (Greenwich Mean Time).

Specify the certificate and click [Export] to export the certificate information. Click [Delete] to delete it from the list.

Create Certificate

Create server certificates.

Important

It is advised to use self-signed certificate for such as operation tests that do not require full security. It is recommended to acquire and install a server certificate issued from CA for a full-scale system operation.

[Generate Certificate Signing Request]

Click [Execute] to create a server private key and generate a certificate signing request.

Once processed, the certificate signing request will be displayed in a separate window.

[Create Self-Signed Certificate]

Enter the following items, click [Apply], and click [Execute] to create a self-signed certificate.

Note

Creating a certificate takes time, so it is recommended to stop the video distribution processes etc.

[Country (C)]

Enter the ISO3166-1 alpha-2 country code.

[State/Province (ST)], [Locality (L)], [Organization (O)], [Organizational Unit (OU)], [Common Name (CN)]

Enter state/province name, locality, organization name, organizational unit and common name in alphanumeric characters (spaces or printable characters).

Enter an FQDN format host name, etc. to set the common name (required).

[Validity Period Start Date], [Validity Period End Date]

Set the validity period of the certificate to be created (required when creating a self-signed certificate).

[System] > [Security] > [SSL/TLS]

Settings for encrypted communications and server certificates.

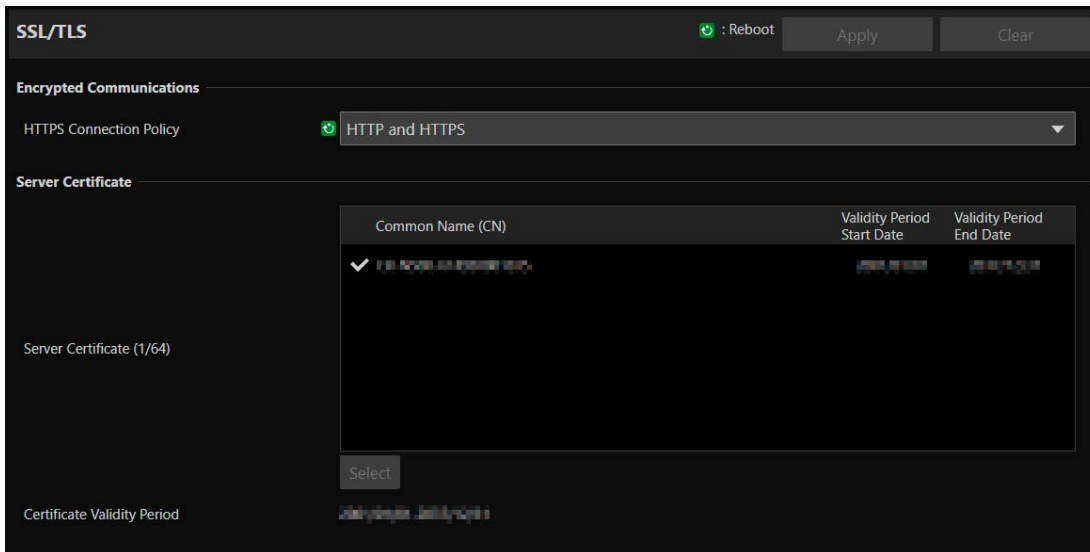

Encrypted Communications

Settings for encrypted communications.

[HTTPS Connection Policy]

Set SSL/TLS communication with HTTPS connections.

Select [HTTP] if SSL/TLS communication is not performed.

Select [HTTPS] or [HTTP and HTTPS] to perform SSL/TLS communication. Connections using SSL/TLS are enabled after rebooting.

If [HTTPS] is selected, HTTP access is also redirected to HTTPS to perform SSL/TLS communication.

Important

- Even if SSL/TLS communication is set to use here, SSL/TLS communication is not performed unless a certificate has not been installed.
- Video distribution performance decreases when performing SSL/TLS communication.

Server Certificate

Settings for server certificate for use.

[Server Certificates]

Select a certificate to use from the certificates registered in [System] > [Security] > [Certificate Management] > [Server Certificate Management], and click [Select]. The selected certificate will take effect after the reboot.

[Certificate Validity Period]

Displays the validity period of the selected certificate.

Note

Depending on the server certificate used by the camera and the computer connected to the camera, it may be necessary to install the root certificate, the intermediate CA certificate, or the certificate selected and exported in [Server Certificate List].

[System] > [Security] > [User Management]

Settings for account to access the camera via an IP connection, such as from a controller.

The screenshot shows the 'User Management' interface with the following sections:

- Administrator Account:** Fields for Administrator Name (5 to 15 characters), Password (8 to 32 characters), and Confirm Password (8 to 32 characters).
- Authorized User Account:** Fields for User Name (5 to 15 characters), Password (8 to 32 characters), and Confirm Password (8 to 32 characters), followed by an 'Add' button.
- User List:** A large empty box with a trash icon and sort buttons (A-Z and Z-A).
- User Authority:** A table with columns for 'Camera Control' and 'Video Distribution', and rows for 'Authorized User' and 'Guest User'. Both rows have checkmarks in both columns.

	Camera Control	Video Distribution
Authorized User	<input checked="" type="checkbox"/>	<input checked="" type="checkbox"/>
Guest User	<input checked="" type="checkbox"/>	<input checked="" type="checkbox"/>

"Administrator", "authorized user", and "guest user" are the three types of accounts that are able to access the camera. For the minimum user settings and permissions required, refer to "Measures Suitable to the Users' Environment 1: User Management" (P. 116).

Administrator:

The administrator can access the Settings Page for all settings including granting privileges to authorized users and guest users. Access the camera with the administrator name and password registered with administrator account.

Authorized User:

This account is used to access the camera by authenticating with a user name and password. It is required to enter a user name and password of the controller or other connecting devices.

Guest User:

The account is used for the device to access the camera without user authentication.

Important

- Multiple administrator accounts cannot connect to a camera at the same time.
- Authorized user and guest user accounts can connect to the camera from multiple devices at the same time.
- When using NDI|HX, RTMP, or SRT, access cannot be controlled by [User Management].

Administrator Account

Settings for changing the administrator account information that was set at initial setting.

Important

- To ensure system security, set the administrator password that should not be easily guessed by third parties. Be sure not to forget the new password.
- If administrator password is forgotten, restore to the factory default settings (P. 102). Note, however, that this will reset all camera settings to factory default settings including the administrator account, the network information, date and time.

[Administrator Name]

Enter the administrator name using alphanumeric characters, hyphens (-), and underscores (_). However, hyphens (-), and underscores (_) cannot be used at the beginning.

[Password]

Enter the administrator password. Use at least two types from alphanumeric characters, numbers, and symbols.

[Confirm Password]

Enter the same password as above for confirmation.

Authorized User Account

Add authorized users.

[User Name], [Password], [Confirm Password]

To add the authorized user, enter the user name and password, then click [Add].

Enter the user name using alphanumeric characters, hyphens (-), and underscores (_).

Up to 15 authorized users can be added.

For password, use at least two types from alphanumeric characters, numbers, and symbols.

[User List]

Displays a list of added authorized users.

Able to sort the list items in ascending order by clicking  and in descending order by clicking .

Select a user in the list and click  to remove the registered user.

User Authority

Set the privileges for authorized users and guest users. This setting enables to set access restrictions for the Settings Page.

[Camera Control], [Video Distribution]

Select the items for granting users privileges.

An authorized user has higher privileges than a guest user.

Important

However, when connected to the RTP server as an authorized user, it is disabled to restrict guest users' privileges.

[System] > [Security] > [Host Access Restrictions]

Access control can be performed individually by address to access over the network. Set IPv4 and IPv6, respectively.

The screenshot shows the 'IPv4 Host Access Restrictions' configuration page. At the top, there are 'Apply' and 'Clear' buttons. Below, the 'Apply Host Access Restrictions' dropdown is set to 'Enable'. The 'Default Policy' dropdown is set to 'Authorize Access'. A table with 18 rows is visible, each with a 'Network Address/Subnet' column and a 'Yes/No' column. All 'Yes' options are selected.

The screenshot shows the 'IPv6 Host Access Restrictions' configuration page. At the top, there are 'Apply' and 'Clear' buttons. Below, the 'Apply Host Access Restrictions' dropdown is set to 'Enable'. The 'Default Policy' dropdown is set to 'Authorize Access'. A table with 17 rows is visible, each with a 'Prefix/Prefix Length' column and a 'Yes/No' column. All 'Yes' options are selected.

Important

- To prohibit access via a proxy server in HTTP connection, a proxy server address must be set.
- If host access restriction is set mistakenly, access to the Settings Pages themselves may be prohibited, in which case restoring the factory default settings will become the only means of recovery.

Note

If the same address is entered, the setting that is displayed higher on the list will be applied.

IPv4 Host Access Restrictions

Specify the hosts from which IPv4 access is permitted and prohibited. This setting is common to wired and wireless LANs.

[Apply Host Access Restrictions]

Select whether to use IPv4 host access restrictions.

[Default Policy]

Select whether to allow or block access from IPv4 addresses that have not been specified in [Network Address/Subnet].

[Network Address/Subnet]

Enter IPv4 addresses into the list and select [Yes] or [No] for access for each address.

It is possible to specify the subnet to set access restrictions by network or host.

If set to [No], access to all ports is blocked.

IPv6 Host Access Restrictions

Specify the hosts from which IPv6 access is permitted and prohibited.

[Apply Host Access Restrictions]

Select whether to use IPv6 host access restrictions.

[Default Policy]

Select whether to allow or block access from IPv6 addresses that have not been specified in [Prefix/Prefix Length].

[Prefix/Prefix Length]

Enter IPv6 addresses (prefixes) into the list and select [Yes] or [No] for access for each address.

It is possible to specify the prefix length to set access restriction by network or host.

If set to [No], access to all ports is blocked.

[System] > [System] > [Camera]

Settings for Camera Name, camera's Installation Conditions, Tally Lamp, IR Remote Controller, and Genlock.

The screenshot shows a 'Camera' settings panel with the following options:

- Camera Name:** A text input field containing 'Camera' with a note 'Up to 15 characters'.
- Installation Conditions:** A dropdown menu for 'Video Flip' set to 'Disable'.
- Tally Lamp:** Two dropdown menus: 'Tally Lamp Control' set to 'Enable' and 'Tally Lamp Brightness' set to 'Medium'.
- IR Remote Controller:** A dropdown menu set to 'Enable'.
- Genlock:** A dropdown menu set to 'Enable' and a 'Genlock Adjustment' slider ranging from -1023 to 1023, currently set to 0.

Camera Name

Settings for the camera name.

[Camera Name]

Enter any camera name.

Installation Conditions

Settings for camera use suitable for the location the camera will be installed.

[Video Flip]

Select whether to vertically flip the video.

Select the setting suited to the camera installation method, such as ceiling mount or placing on a desk.

Tally Lamp

Settings for the tally lamp.

[Tally Lamp Control]

Select whether to use tally lamp control.

[Tally Lamp Brightness]

Select the brightness of the tally lamp when [Tally Lamp Control] is set to [Enable].

IR Remote Controller

Settings for the IR remote controller.

[IR Remote Controller]

Select whether to use IR remote controller.

For details on IR remote controller, refer to "Chapter 3 IR Remote Controller" (P. 87).

Genlock

N500

Genlock enables to synchronize the video signal of the camera with the external video device.

Use the GEN-LOCK terminal to input external sync signals (analog black burst signal or HD ternary signal) to the camera.

[Genlock]

Select whether to use Genlock.

[Genlock Adjustment]

Adjusts the H phase of the genlock in the range of approximately ± 0.4 H around the phase difference 0.



Note

- When a synchronizable Genlock signal is inputted, synchronization will stabilize after approximately 10 seconds.
- If an incorrect Genlock signal is inputted, synchronization may not be stable.

[System] > [System] > [Date and Time]

Settings for camera date and time.

Date and Time [Apply] [Clear]

Current Date and Time

Date: yyyy/mm/dd [2023/01/01]

Time: hh:mm:ss [12:00:00]

Settings

Settings Method: Synchronize with NTP server

Set NTP Server Settings Automatically: Disable

NTP Server (Up to 63 characters): XXXXX

Synchronization Interval (minutes) (5 - 1440): 60

Last Sync Time: []

Time Zone: (GMT+09:00) Osaka, Sapporo, Tokyo

Daylight Saving Time: Disable

Current Date and Time

The date and time set in the camera are displayed.

Settings

It is possible to change the date and time setting method, time zone and daylight saving time set at initial setting.

[Settings Method]

Select the date and time setting method.

[Set manually]

Set the desired date and time in [Date] and [Time].

Set the time in 24-hour format in <hour:minute:second> order.

[Synchronize with NTP server]

Synchronize with the time of NTP server specified in the displayed [Set NTP Server Settings Automatically].

[Set NTP Server Settings Automatically]

Select one of the following setting methods:

[Disable]

Enter the IP address or host name of the NTP server in [NTP Server].

[Use DHCP]

The camera's time is synchronized with the time of the NTP server at the address acquired from the DHCP server.

The acquired NTP server address is displayed in [NTP Server (DHCP)].

In order to set this, change [System] > [Communication] > [Network] > [IPv4] > [IPv4 Address Settings Method] to [Auto (DHCP)] (P. 59).

[Use DHCPv6]

The camera's time is synchronized with the time of the NTP server at the address acquired from the DHCPv6 server.

The acquired NTP server address is displayed in [NTP Server (DHCPv6)].

In order to set this, change [System] > [Communication] > [Network] > [IPv6] > [IPv6] to [Enable], then set [Auto (DHCPv6)] to [Enable] (P. 60).

[Use DHCP/DHCPv6]

The camera's time is synchronized with the time of the NTP server at the address acquired from the DHCP server or DHCPv6 server.

If the NTP server address can be acquired from both the DHCP server (IPv4) and DHCPv6 server, the NTP server address acquired from the DHCP server (IPv4) will be used.

[Synchronization Interval (minutes)]

Enter the query interval for the specified NTP server.

[Last Sync Time]

The time last synchronized with the specified NTP server will be displayed.

[Synchronize with computer time]

The date and time will be synchronized with that of the computer currently accessing the camera. After clicking [Apply], [Settings Method] will change to [Set manually].

[Time Zone] is not automatically selected, so set it if necessary.

 **Note**

If the NTP server IP address is incorrect or a connection with the NTP server cannot otherwise be established, [Last Sync Time] will not be updated, or will be left blank.

[Time Zone]

Select the appropriate GMT (Greenwich Mean Time) time difference.

When the time zone is changed and [Apply] is selected, the date and time will be automatically changed based on the selected time zone.

[Daylight Saving Time]

Select whether to automatically adjust for daylight saving time to suit the time zone.

[System] > [System] > [Environment]

Settings for the frame frequency.

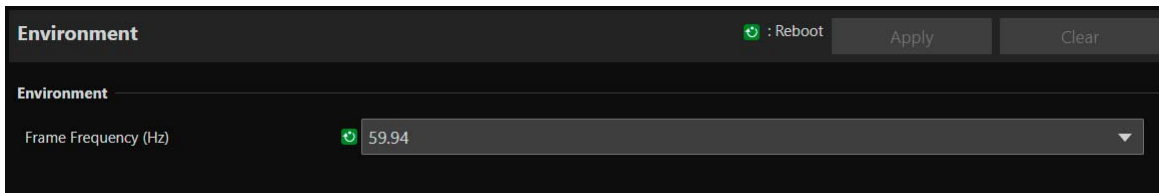

Environment

Setting the frame frequency.

[Frame Frequency (Hz)]

Frame frequency can be changed by the initial settings. The HDMI/SDI output signal format and the frame rate of the IP streaming video are selected according to the frame frequency. Options for [Exposure] > [Shutter Mode] > [Slow (sec.)] also will be changed, so check the settings of presets if they were registered.

[System] > [System] > [Language]

Set the language to be displayed on the Settings Page.

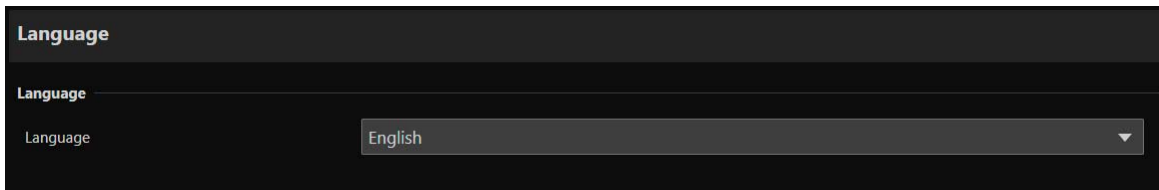

The screenshot shows a dark-themed settings interface. At the top, the word "Language" is displayed in a bold, light-colored font. Below this, there is a label "Language" followed by a horizontal line. Underneath the line, the word "Language" is repeated, followed by a dropdown menu. The dropdown menu is currently set to "English" and has a small downward-pointing arrow on its right side.

Language

Select the display language.

[System] > [Maintenance] > [General]

Check camera information such as the firmware version, and perform maintenance on the camera system.

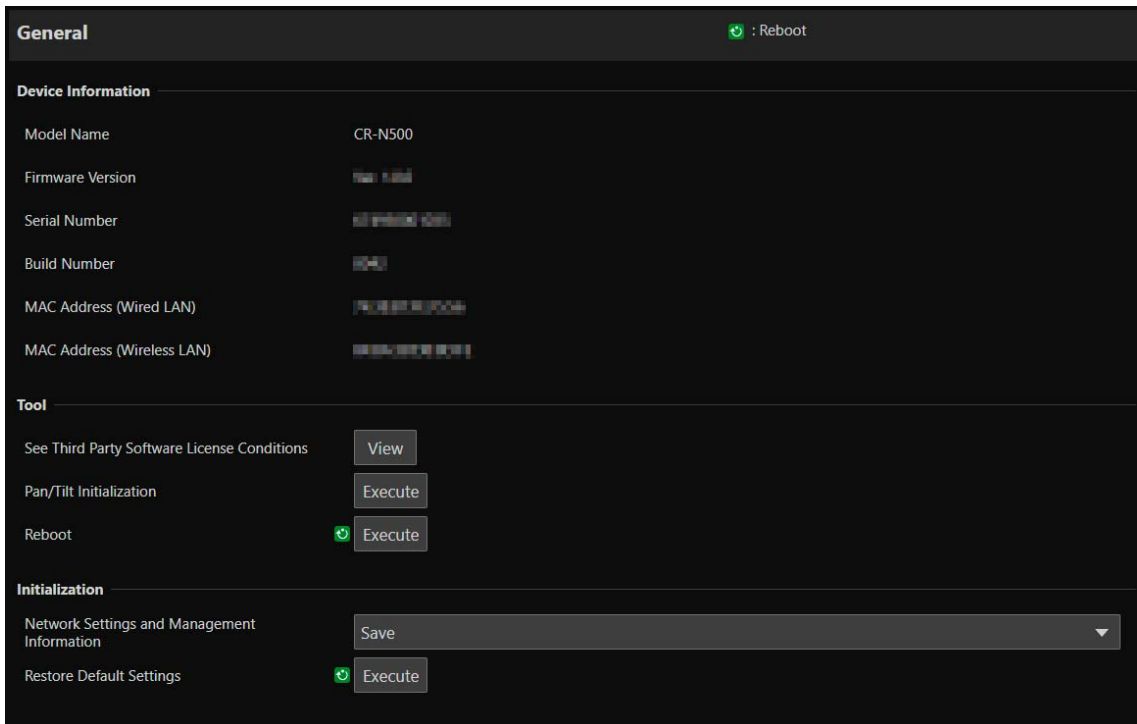

Device Information

[Model Name], [Firmware Version], [Serial Number], [Build Number], [MAC Address (Wired LAN)], [MAC Address (Wireless LAN)]

Displays information about the camera.

Tool

Displays license, initialization of the Pan/Tilt settings, and rebooting the camera.

[See Third Party Software License Conditions]

Third party software license information is displayed as a list.

[Pan/Tilt Initialization]

If the Pan/Tilt position shifts, click [Execute] to initialize the position.

[Reboot]

Reboots the camera.

Initialization

Initialize the camera.



Important

- Do not turn off the power to the camera while performing [Restore Default Settings]. Turning off the camera at this stage may result in disabling its ability to boot correctly.
- Once [OK] is clicked, the process of restoring the default settings cannot be interrupted.

[Network Settings and Management Information]

When set to [Save], initialization will be performed except for the following settings.

- Network Settings
- NTP Server
- HTTP Server
- Host Access Restrictions
- Time Zone
- Certificates
- SSL/TLS
- Administrator Name
- Administrator Password

When set to [Do not save], initialization will be performed all the settings excluding camera's date and time.

Since the network settings will be initialized, connection to the camera will not be enabled. Use the Camera Search Tool to configure the initial settings.



Note

Even if the [Network Settings and Management Information] is set to [Save], the [Wireless LAN] setting will be initialized.

[Restore Default Settings]

After rebooting, follow the selection in [Network Settings and Management Information] to restore the default settings.



Note

- Before clicking [Execute] in [Restore Default Settings], it is recommended to back up the current settings.
- It is possible to restore the factory default settings by using the RESET switch, but be aware that all the settings except the camera date and time will be restored to the factory default settings (P. 102).

[System] > [Maintenance] > [Backup/Restore]

This will save/restore all the camera settings.

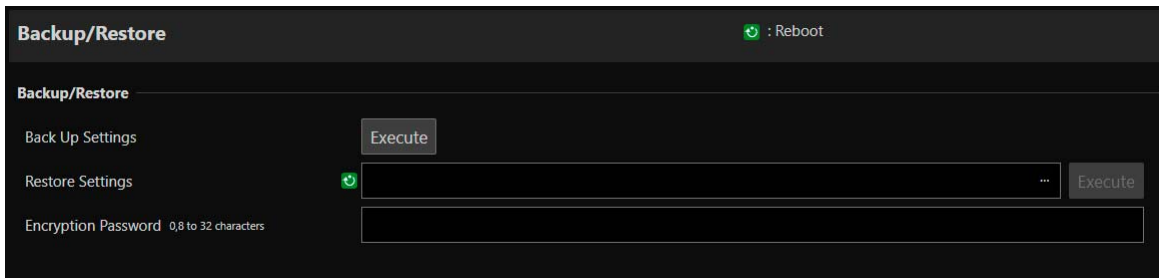

Backup/Restore

Settings related to backup and restoring.

Important

Do not turn off the power to the camera while performing [Back Up Settings] or [Restore Settings]. Turning off the camera at this stage may result in disabling its ability to boot correctly.

[Back Up Settings]

All settings except date and time will be backed up. The administrator account and certificates used in SSL/TLS, including private key will also be backed up.

[Restore Settings]

Restores all settings, except date and time, from the backup file created with [Back Up Settings]. The administrator account, IP address and certificates used by SSL/TLS, including private key will also be restored. After restoring, the camera will be rebooted.

Important

- Be aware that if restored from a backup file of another camera, problems such as duplicate addresses on the network or overwriting with a different Administrator Password may cause problems such as being unable to connect to the camera.
- When restoring the settings, do not use a backup file created with a firmware version newer than that of the camera to restore.

[Encryption Password]

Able to set a password to use when backing up and restoring. This is the password for encrypting the backup data itself. When restoring from encrypted backup data, enter the password set when backing up. Use at least two types of single-byte alphanumeric characters, numbers, or symbols.

Note

The settings are not restored if the password set when backing up and the password set when restoring do not match.

[System] > [Maintenance] > [Update Firmware]

Perform firmware update.

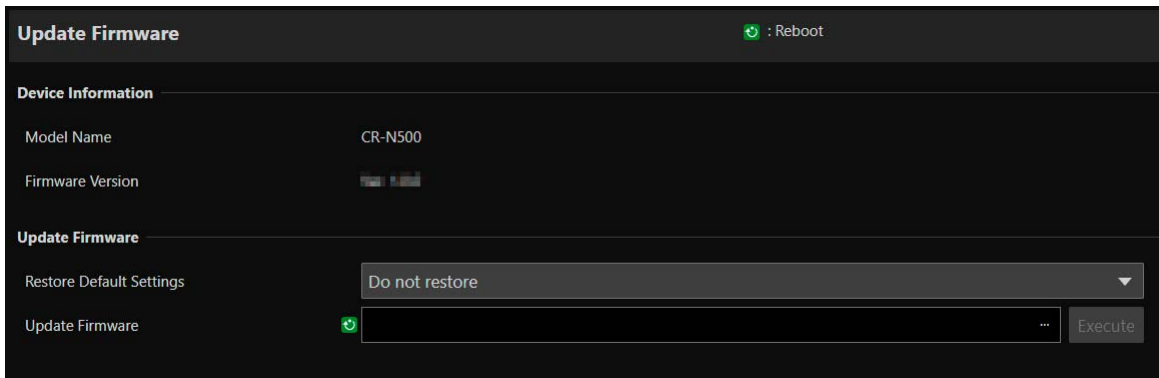

Update Firmware Reboot

Device Information

Model Name: CR-N500

Firmware Version: 1.0.0

Update Firmware

Restore Default Settings: Do not restore

Update Firmware Execute

Device Information

[Model Name], [Firmware Version]
Camera information is displayed.

Update Firmware

Performs firmware update.

Important

Do not turn off the power to the camera while performing [Update Firmware]. Turning off the camera at this stage may result in disabling its ability to boot correctly.

[Restore Default Settings]

Updating the firmware restores to the default settings.

If set to [Restore], everything is restored except the following settings.

- Network Settings
- NTP Server
- HTTP Server
- Host Access Restrictions
- Time Zone
- Certificates
- SSL/TLS
- Administrator Name
- Administrator Password

Note

Even if the [Restore Default Settings] is set to [Do not restore], the [Wireless LAN] setting will be restored.

[Update Firmware]

Click [...] to select the firmware file for updating and click [Execute]. When a confirmation message is displayed, click [OK] to start Update Firmware. During update, the camera's front STATUS lamp will blink.

After update firmware is performed, the camera will be rebooted.

[System] > [Maintenance] > [Log]

Display and download log messages.

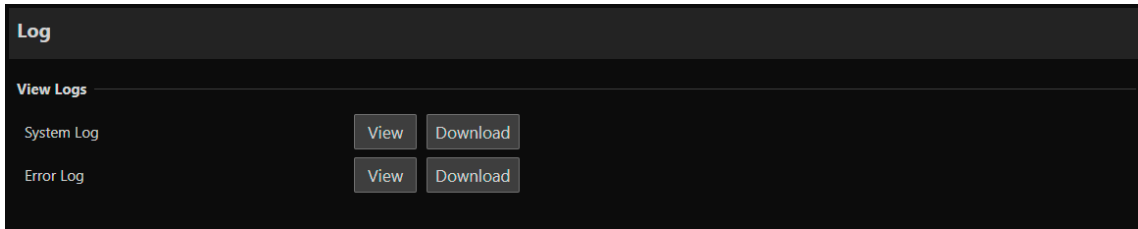

View Logs

Displays the history of camera operation and connection.

[System Log], [Error Log]

When [View] is clicked, log messages from the time the camera was turned on is displayed.

When [Download] is clicked, the message list can be downloaded as a file.

For details on log message, refer to "List of Log Messages" (P. 95).

Chapter 3

IR Remote Controller

This section describes the features and handling of the included IR remote controller.

Names and Functions of Parts

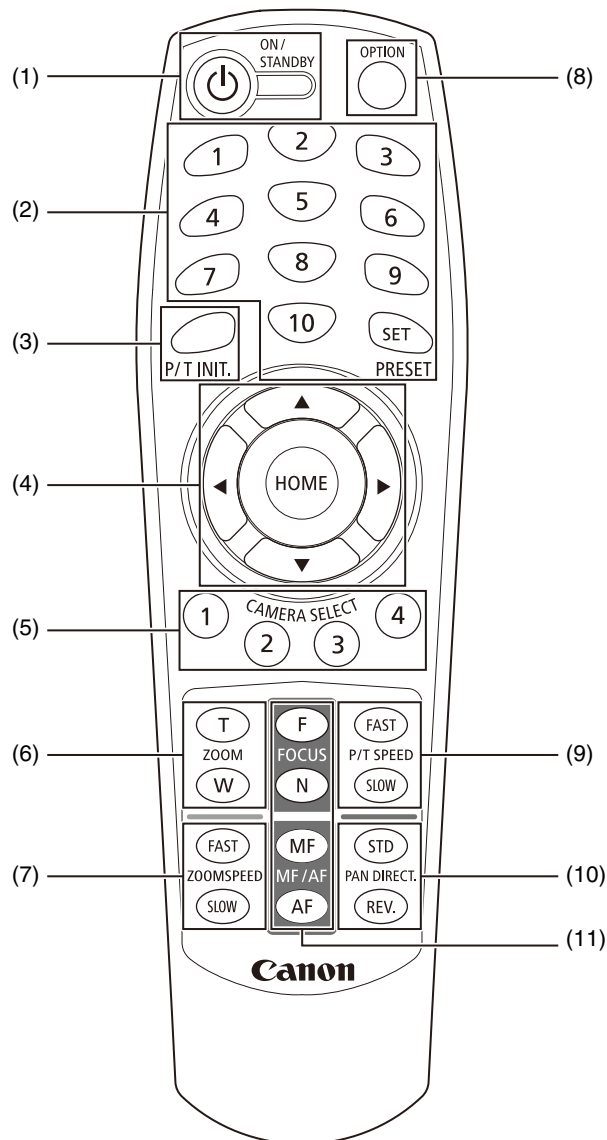

(1) ON/STANDBY button

Use the button to switch between the camera on and standby mode. Set it to standby if required to stop HDMI/SD output or IP distribution of videos.

When the camera receives the remote controller's signal, the POWER lamp on the front of the camera blinks twice (green).

The POWER lamp lights up (orange) when the camera is in standby, and blinks (green) when the camera is returning to standby.

(2) PRESET

Set or call a preset.

If a number (1 to 10) is pressed while pressing the SET button, the current camera settings such as camera angle, zoom and focus are saved as a preset to that number. Press the number (1 to 10) to call the registered preset.

Note

- Registrable presets are 1 to 10. Presets unable to register are 11 to 100.
- If any preset is registered to 1 to 10, the new setting is overwritten.
- When calling a preset with the IR Remote Controller, the preset is called at the speed set in advance in P/T SPEED.
- Presets from the IR remote controller are unable to be deleted.

(3) **P/T INIT. button**

If the pan/tilt position is shifted, press the P/T INIT. button to initialize the position.

(4) **▲, ▼, ◀, ▶, HOME button**

Press ▲ or ▼ button to change the camera angle in the tilt direction, or press ◀ or ▶ button to change the camera angle in the pan direction.

Press the HOME button to return the camera angle to the front (home position).

(5) **CAMERA SELECT**

Press the number of the camera wanting to operate with the IR remote controller.

Use the SERVICE switch on the back of the camera to set the camera number.

 **Note**

If there is a camera set to the same camera number nearby, the IR remote controller may operate the cameras simultaneously.

It is recommended to use a different camera number for cameras installed nearby.

For details on setting the camera number, refer to "Installation Guide/Important Information".

(6) **ZOOM**

Press the T button to zoom in (telephoto), and the W button to zoom out (wide angle).

(7) **ZOOMSPEED**

Adjusts the zoom speed.

Press the FAST button to increase the operating speed or the SLOW button to decrease it.

(8) **OPTION button**

Not supported (for future expansion).

(9) **P/T SPEED**

Adjusts the pan/tilt speed.

Press the FAST button to increase the operating speed or the SLOW button to decrease it.

(10) **PAN DIRECT.**

Press the REV. button to reverse the panning direction.

Press the STD button to return to the original direction.

(11) **FOCUS, MF/AF**

Use for focusing.

Press the AF button to adjust the focus automatically. To adjust the focus manually, press the MF button, then the F (FAR) button and the N (NEAR) button to adjust.

Handling the Remote Controller

■ Battery Replacement

Remove the battery cover on the back of the remote controller, and insert two new AAA batteries by paying attention to the + positive and - negative directions. Close the battery cover tightly until it snaps.

■ Precautions

- If the remote controller does not work, replace the battery with a new one.
- Do not drop or damage the remote controller.
- Avoid getting liquid on the remote controller. This may cause the remote controller to malfunction.

Chapter 4

Appendix

This chapter explains the measures to take when trouble occurs or a log message is displayed during camera use.

It also explains how to reset the USB camera function **N300** or camera to the factory default settings, perform routine maintenance, major specifications and camera security measures.

USB Camera Functions (CR-N300)

By connecting the camera and the computer using a USB cable sold on the market, it can be used as a USB camera. Using a computer with a web conference tool installed, it is possible to hold a web conference with high quality video.

In order to use as a USB camera, follow the procedure below for the settings.

- 1** With the camera connected to the network, make necessary settings from the Settings page.
The frame frequency has to be set at 59.94 Hz or 50.00 Hz (P. 80).
- 2** Turn off the camera once, then switch the SERVICE switch setting of the camera to USB camera.
For details, refer to the "Installation Guide/Important Information".
- 3** Connect the camera and the computer with a USB cable. Then turn on the camera again.

Note

- When switched to USB camera, access to the Settings Page, IP streaming of video and operations from controllers except for IR remote controller will be disabled.
- Audio output from the microphone connected to the camera is not possible.
- The video size is either 1920 x 1080, 1280 x 720, or 640 x 360, depending on the web conference tool.

Image Adjustment/Camera Control Functions

As a USB camera, image adjustment and camera control functions that can be controlled are as follows.
The items that can be controlled differ depending on the web conference tool.

Control Item	Minimum	Maximum	Default	Increments	Auto/Manual
Brightness	-8	+8	0	1	Manual
White Balance (K)	2000	15000	5600	100	Auto/Manual
Backlight Compensation	0	1	0	1	Manual
Gain (dB)	0	36	20	1	Manual
Zoom* ¹	0	2808	0	1	Manual
Exposure	-11	-3	-6	1	Auto/Manual
Aperture (Iris)* ²	1800	22000	1800	10	Auto/Manual
Pan (°)	-170	+170	0	1	Manual
Tilt (°)	-30 (-100) * ³	+100 (+30) * ³	0	1	Manual

*1 Limited to the optical zoom range

*2 Aperture value multiplied by 1000 (i.e.: 2800 means F2.8)

*3 When the image is reversed

Note

Among the control items defined by UVC (USB Video Class), following functions are not supported.

- Contrast, Hue, Saturation, Sharpness, Gamma, Color Enable, Power Line Frequency (Anti Flicker), Focus, Roll, and Low Light Compensation

Troubleshooting

Before contacting the dealer from where the product was purchased or Canon Customer Service Center, check the following items. If a log message is displayed, check the details of the message and the corresponding countermeasures in the log message list.

Note

- For information on troubleshooting for the Remote Camera Control Application, the Remote Camera Controller RC-IP100, refer to each manual.
- A problem caused by the security software may occur. Configure to exclude the camera, or the software where the problem occurred, in the security software.

Problem	Countermeasures
The camera does not launch.	<ul style="list-style-type: none"> • If a PoE+ hub being used, check if the LAN cable is connected correctly. • If an Compact Power Adapter is being used, check if the Compact Power Adapter is connected correctly. • Turn the camera off and restart (Refer to "Installation Guide/Important Information"). • Some PoE+ supported hubs limit the power used per port or the total power consumed by each port. If the limit is exceeded, it may not start, so check the instructions of PoE+ supported hub for use.
Settings Page is not displayed.	<ul style="list-style-type: none"> • Check if the LAN cable is connected correctly. • Check if the network to which the camera is connected is set up correctly. In particular, check if the IP address, subnet mask and default gateway address are set within the ranges supported by the applicable network. • If the IP address was changed, the new address will not become effective until the camera is rebooted. • Check if the correct URI (camera IP address) is entered in the web browser. • Check whether the connection is from a computer whose access is blocked in [System] > [Security] > [Host Access Restrictions] (P. 74). • Configure to exclude the camera, or the software where the problem occurred, in the security software. • The camera's SERVICE switch is set as a USB camera. Switch the SERVICE switch and restart the camera (Refer to "Installation Guide/Important Information"). N300
Unable to connect to the camera in wireless LAN.	<ul style="list-style-type: none"> • Exceeds the maximum number of devices that can be connected to the camera via wireless LAN. Disconnect the wireless LAN connection of the devices that do not use the camera. • There is a possibility that the signal is bad or there is signal interference by electronic equipment around the camera. Refer to "Cautions and Troubleshooting for Wireless LAN Connection" (P. 22) and respond accordingly. • Reset the camera (P. 82) and start from the initial settings again (P. 17).
Unable to operate the camera from the IR remote controller.	<ul style="list-style-type: none"> • Go to [System] > [System] > [Camera], and select [Enable] for [IR Remote Controller] (P. 77). • Check the IR remote controller's CAMERA SELECT number and the setting of the SERVICE switch on the rear of the camera.
The camera cannot be operated from the IR remote controller that supports Standard Communication (Serial).	<ul style="list-style-type: none"> • RS-422 connection is not working correctly. Check the connection to the RS-422 terminal and the wiring of the RS-422 cable. • The remote controller and the setting of serial connection on the Settings Page are different. Select [System] > [Communication] > [External Connection (Serial)], check [Serial Device Address], and set the camera number to the same as that of the remote controller. Also set Baud Rate (9600 bps or 38400 bps) to the same setting.
There is no audio during IP distribution.	<ul style="list-style-type: none"> • If there is no audio, check the settings in [System] > [Video and Audio] > [Audio] as well as the sound and audio device settings for the computer. • Audio cannot be heard on the Settings Page.
There is no video or audio on the external monitor during HDMI/SDI output.	<ul style="list-style-type: none"> • The camera is not properly connected to an external monitor. Check the cable connections, reseal the cable, or turn the camera off and restart. • Set the external monitor according to the output signal of the camera.

Problem	Countermeasures
There is no audio.	<ul style="list-style-type: none"> Set [System] > [Video and Audio] > [Audio] > [General Audio] > [Audio Input Mode] correctly, depending on the microphone connected. If an external microphone requires phantom power for the INPUT terminal, set [System] > [Video and Audio] > [Audio] > [General Audio] > [Audio Input Mode] to [INPUT Terminal/MIC+48V]. When used as a USB camera, audio cannot be inputted from the camera to the computer. Input the audio directly to the computer from the microphone. N300
The sound is distorted or reduced.	<ul style="list-style-type: none"> Shooting near loud sounds (fireworks, concerts, etc.) may distort or make the sound smaller than it actually is. In [System] > [Video and Audio] > [Audio] > [General Audio] > [Input Volume], adjust the volume of the input audio.
Forgot the administrator password.	<ul style="list-style-type: none"> It is possible to initialize all settings of the camera excluding date and time using the RESET switch (P. 102). After performing initialization, use the Camera Search Tool to register the administrator account again. The IP address and subnet mask, etc. also need to be set again because the network settings are initialized.
The tally lamp does not light.	<ul style="list-style-type: none"> In [System] > [System] > [Camera], set [Tally Lamp Control] to [Enable].
The STATUS lamp on the front of the camera is blinking.	<ul style="list-style-type: none"> The firmware of the camera is being updated. It may take a while. The pan/tilt position is shifted. Executing [Pan/Tilt Initialization] in [System] > [Maintenance] > [General] > [Tool] initializes the pan/tilt position. If using an IR remote controller, press the P/T INIT button to initialize. If the POWER lamp is also blinking, there may be some abnormality occurred to the camera. Restart the camera. If the problem is still not solved, contact the sales representative.
Out of focus.	<ul style="list-style-type: none"> When autofocus is used to control the focus, some subjects may be difficult to focus on automatically. If this happens, adjust the focus manually. When [AF Mode] is set to [AF-Boosted MF], start focusing manually until you approach the in-focus position. N500 If the lens is dirty, please clean it. For details, refer to "Cleaning the Lens" (P. 107).
Subject appears bent diagonally.	<ul style="list-style-type: none"> When shooting a fast-moving subject with the camera or when the angle of view changes during shooting, the subject may appear to be bent diagonally. This is a phenomenon that occurs when a CMOS image sensor is used, and is not a camera malfunction.
The image rotates in the opposite direction to the camera operation.	<ul style="list-style-type: none"> Make sure [System] > [System] > [Camera] > [Installation Conditions] is set to [Video Flip] correctly (P. 76). If connecting to a remote controller, the setting of the controller may be reverse. For details, refer to the instruction manual of controller.
Files cannot be saved.	<ul style="list-style-type: none"> Operation System prohibits saving to certain folders. Accordingly, an attempt to save a file may fail. Specify [Documents], [Pictures] and other folders.

■ POWER/STATUS Lamp

POWER lamp	STATUS lamp	Status
Green light BLINKING	OFF	Power being switched on
Green light ON	OFF	POWER ON
Green light BLINKING (twice)	OFF	Signal received from IR remote controller
Orange light ON	Orange light ON	Standby
Green light BLINKING	OFF	Changing to or from standby
OFF	Orange light ON	Insufficient power
OFF	Orange light BLINKING	Pan/Tilt position error, firmware being updated
Green light BLINKING	Orange light BLINKING	Device failure

List of Log Messages

Log Messages on the Camera

The list of log messages displayed in [System] > [Maintenance] > [Log] > [View Logs] on the Settings Page (P. 86). Log messages are classified into the following types.

Category	Level	Code	Fault level
crit	Error	4xx	Software-level failure (Task operations will stop)
err	Error	3xx	Operational error (Operations will continue)
warning	Warning	2xx	Non-operational error
notice	Warning	1xx	Error external to the system
info	Information	0xx	Information on normal operation



Note

If no content is recorded in a log for approximately two hours, "-- MARK --" will be recorded in the message area.

Error Log

System Error

S303 Error on saving settings [err]

Description	Can't update files of system settings (S303)
Meaning	An error generated while the system was saving a setting, Can't update system settings.
Countermeasure	If the error is detected after rebooting, initialize to the factory default settings. If the problem persists, contact the dealer.

S320 PAN/TILT operation error [err]

Description	%1 error occurred. [%2] (S320)
%1	PAN TILT
%2	Error details
Meaning	An error occurred during operation or stopping of PAN/TILT.
Countermeasure	Check if there is anything that interferes with the PAN/TILT operation, such as the contact of the camera head with something. After resolving, execute [Pan/Tilt Initialization] (P. 82). If it is still not resolved, it may be a camera failure, so contact the dealer.

S330 Broken Fan [err]

Description	FAN does not rotate. (S330)
Meaning	The fan does not rotate or a significant decrease in speed is detected.
Countermeasure	If the error is still detected after rebooting, it may be a failure with the fan, so contact the dealer.

S332 Fan Operation has failed [err]

Description	Cannot control FAN. (S332)
Meaning	IO is not available to control the fan.
Countermeasure	If the error is still detected after rebooting, it may be a fan failure, so contact the dealer.

S350 Error in resuming from or switching to standby [err]

Description	Failed to resume from standby or switch to standby (S350)
Meaning	Failed to resume from or switch to the standby status.
Countermeasure	If the error is still detected after rebooting, contact the dealer.

S360 Audio Video synchronize error [err]

Description	Audio Video synchronize error. (S360)
Meaning	Video/Audio synchronize error
Countermeasure	If the error is still detected after rebooting, it may be a failure, so contact the dealer.

S430 Temperature sensor failure [crit]

Description	cannot get temperature (S430)
Meaning	Cannot get the temperature from the temperature sensor.
Countermeasure	If the error is still detected after rebooting, it may be a failure of the board, so contact the dealer.

■ Audio server error

B301 Audio device error [err]

Description	cannot use audio device for %1 [%2:%3] (B301)
%1	Send/Receive type (rx tx)
%2	Error type (open write flush)
%3	Error number
Meaning	Detected an error in the audio device.
Countermeasure	If the error is still not cleared, contact the dealer.

B402 Audio server initialization failed [err]

Description	wvaudio initialization error [%1] (B402)
%1	Error number
Meaning	The audio server could not be initialized. The audio server stops.
Countermeasure	If the error is still detected after rebooting, it may be a failure, so contact the dealer.

B403 Settings change failed [err]

Description	cannot set config [%1:%2] (B403)
%1	Error notification number
%2	Error number
Meaning	The settings could not be updated. The audio server stops.
Countermeasure	If the error is still detected after rebooting, it may be a failure, so contact the dealer.

■ Video error

V400 Video input initialization error [crit]

Description	video %1 initialization failure - %2 (%3) (V400)
%1	Video number
%2	Process description
%3	Error details
Meaning	The video input function was stopped because the video input system could not be initialized.
Countermeasure	If the error is still detected after rebooting, it may be a failure, so contact the dealer.

V401 Video input command error [crit]

Description	video command error - %1 (V401)
%1	Procedure details
Meaning	The video input function was stopped because a video input command could not be processed. Or, it may not operate in the desired setting.
Countermeasure	If the error is still detected after rebooting, it may be a failure, so contact the dealer.

V402 Video input frozen [crit]

Description	video %1 stalled (V402)
%1	Video number
Meaning	The video input function was stopped because the video input from the camera stopped.
Countermeasure	If the error is still detected after rebooting, it may be a failure, so contact the dealer.

■ Standard communication (IP) error

D401 Standard communication (IP) initialization failed [crit]

Description	Standard Com initialization error[%1] (D401)
%1	Error number
Meaning	Standard communication (IP) could not be initialized.
Countermeasure	If the error is still detected after rebooting, it may be a failure, so contact the dealer.

■ RTP error

R401 RTP initialization failed [crit]

Description	RTP initialization error[%1] (R401)
%1	Error number
Meaning	RTP could not be initialized.
Countermeasure	If the error is still detected after rebooting, it may be a failure, so contact the dealer.

■ NDI|HX error

P401 NDI|HX initialization failed [crit]

Description	NDI HX initialization error[%1] (P401)
%1	Error number
Meaning	NDI HX could not be initialized.
Countermeasure	If the error is still detected after rebooting, it may be a failure, so contact the dealer.

■ SRT error

T401 SRT initialization failure [crit]

Description	SRT initialization error [%1] (T401)
%1	Error number
Meaning	SRT initialization failed.
Countermeasure	If the error is still detected after rebooting, it may be a failure, so contact the dealer.

■ Output Tracking Data error

F301 Output Tracking Data startup error [err]

Description	freed initialization error [%1] (F301)
%1	Error number
Meaning	Output Tracking Data startup failed.
Countermeasure	If the error is still detected after rebooting, it may be a failure, so contact the dealer.

Warning log

■ Audio server warning

B203 Audio message send failure [warning]

Description	audio message send error %1 [%2] (B203)
%1	Message type
%2	Error number
Meaning	Failed to send audio message.

B204 Audio message receive error [warning]

Description	audio message rcv error [%1:%2] (B204)
%1	Error notification number
%2	Reason for error
Meaning	Failed to receive audio message.

■ Camera application warning

C211 Camera control command overflow [warning]

Description	command queue overflowed (C211)
Meaning	The camera control command queue overflowed, and some commands were discarded.
Countermeasure	Send the camera control command again after a while.

■ RTP warning

R101 RTSP authentication failure [notice]

Description	RTSP Error: error_code=401: Unauthorized (R101)
Meaning	RTSP authentication failed.

R102 RTSP connection failure [notice]

Description	RTSP Error: error_code=%d: (R102)
%d	400: When an invalid RTSP request is received etc. 503: The maximum number of RTP connections has been exceeded, or a request for multiple session streaming with tunneling for the same stream has been received, etc.
Meaning	RTSP connection has failed.

R103 RTP session disconnected [notice]

Description	session closed: num_of_sessions=%1 (R103)
%1	Total number of sessions for clients
Meaning	The session was disconnected from the client due to a factor other than TEARDOWN. (For example, TCP FIN)

R104 RTP session deleted [notice]

Description	session removed: num_of_sessions=%1 (R104)
%1	Total number of sessions for clients
Meaning	The session was deleted due to errors. (Session Timeout or when an invalid RTSP request is received)

SRT warning

T201 SRT connection failure [warning]

Description	SRT connection error: %1 (T201)
%1	caller connection: Connection error (in Caller mode)
Meaning	SRT connection failed.

Output Tracking Data warning

F201 Output Tracking Data transmission failure [warning]

Description	free-d message output error IP: %1 (F201)
%1	Destination IP address
Meaning	Tracking data transmission failed.

Notification log

System notification

S001 System started [info]

Description	starting paramd (S001)
Meaning	Parameter management module started.

S002 System settings changed [info]

Description	Updated system settings. (S002)
Meaning	Settings not requiring rebooting were changed.

S070 Change to certificate [info]

Description	%1: succeeded to %2 certificate (S070)
%1	ssl
%2	generate import delete export
Meaning	A certificate was created/imported/deleted/exported

S080 The power required to start the camera system is not supplied [info]

Description	Insufficient power to boot the camera system. (S080)
Meaning	The power required to start the camera system is not being supplied.
Countermeasure	Use a DC or PoE+ supported L2 switch as the power source.

S046 Connect a device through a wireless LAN [info]

Description	Connected : %1 (S046)
%1	MAC address of the connected device
Meaning	Device successfully connected.

S047 Disconnect a device connected through a wireless LAN [info]

Description	Disconnected: %1 (S047)
%1	MAC address of the connected device
Meaning	Disconnected from the device.

S043 Wireless LAN Interface Enabled [info]

Description	wireless interface enabled (S043)
Meaning	The wireless LAN interface is enabled.

S045 Wireless LAN Interface Disabled [info]

Description	wireless LAN interface disabled (S045)
Meaning	The wireless LAN interface has been disabled.

S050 IPv4 address assigned to wired LAN interface [info]

Description	IPv4 Address %1 %2 was assigned to the wired I/F (S050)
%1	Set IPv4 address
%2	"from router" for DHCPv4 address
Meaning	IPv4 address is set for wired LAN.

S051 IPv6 address assigned to wired LAN interface [info]

Description	IPv6 Address %1 %2 was assigned to the wired I/F (S051)
%1	Set IPv6 address
%2	"from router" for DHCPv6/RA address
Meaning	IPv6 address is set for wired LAN.

S052 IPv4 address assigned to wireless LAN interface [info]

Description	IPv4 Address %1 was assigned to the wireless I/F (S052)
%1	Assigned IPv4 address
Meaning	IPv6 address is assigned to wired LAN.

S054 IPv4 address for wired LAN interface is released [info]

Description	IPv4 Address %1 %2 was released from the wired I/F (S054)
%1	Released IPv4 address
%2	"from router" for DHCPv4 address
Meaning	IPv4 address assigned to wired LAN is released.

S055 IPv6 address for wired LAN interface is released [info]

Description	IPv6 Address %1 %2 was released from the wired I/F (S055)
%1	Released IPv6 address
%2	"from router" for DHCPv6/RA address
Meaning	IPv6 address assigned to wired LAN is released.

S056 IPv4 address for wireless LAN interface is released [info]

Description	IPv4 Address %s was released to the wireless I/F (S056)
%1	Released IPv4 address
Meaning	IPv4 address assigned to wireless LAN is released.

S140 Wired LAN and wireless LAN interface on the same subnet [notice]

Description	same subnet ethernet interface and wireless LAN interface (S140)
Meaning	The wired and wireless LANs are configured on the same subnet.

■ HTTP Server Notification

H001 System started/stopped [info]

Description	%1 httpd (H001)
%1	starting stopping
Meaning	HTTP Server started/stopped.

H145 Authentication failure [notice]

Description	Authentication failed for %1, IP: %2 (H145)
%1	Implemented countermeasures against URL XSS vulnerability (Equivalent to ftpd)
%2	IP address
Meaning	Authentication failed.

■ wvhttp notification

W001 System started/stopped [info]

Description	%1 wvhttp (W001)
%1	starting stopping
Meaning	wvhttp server started/stopped.

W030 Startup and shutdown of wvhttp Client [info]

Description	%1%2 host=<Host>, user=<User>, prio=<Priority>(W030)
%1	W (wvhttp session V (Session-less video client) N (Session-less event client)
%2	+: Connect, -: Disconnect
Meaning	The camera server client was connected or disconnected.

W031 Transmitted video data size [info]

Description	%1= host=<Host>, user=<User>, video=<Number of frames> (W031)
%1	W (wvhttp session V (Session-less video client)
Meaning	When a client disconnected, the total data that was sent to the client is displayed in number of frames.

W103 Authentication failure [notice]

Description	Authentication failed, IP: <IP address> (W103)
Meaning	Authentication failed.

■ Audio server notification

B001 Audio server started/stopped [info]

Description	%1 audio. (B001)
%1	starting stopping
Meaning	The audio server started/stopped.

B101 Received unusual request [notice]

Description	%1 unusual request[%2] (B101)
%1	Client host IP address
%2	Unusual type (400 404)
Meaning	Refused the request due to command error (400) and parameter error (404).

■ Camera application notification

C001 Camera control module started/stopped [info]

Description	%1 camerad (C001)
%1	starting stopping
Meaning	The camera control module started/stopped.

C002 Camera application started/stopped [info]

Description	starting cameraappl (C002)
Meaning	The camera application started.

■ Video notification

V001 Video server started/stopped [info]

Description	%1 video (V001)
%1	starting stopping
Meaning	The video server started/stopped.

■ Standard communication (IP) notification

D001 Standard communication (IP) notification started/stopped [info]

Description	%1 Standard Com (D001)
%1	starting stopping
Meaning	The standard communication (IP) started/stopped.

■ RTP notification

R001 RTP started/stopped [info]

Description	%1 RTP (R001)
%1	starting stopping
Meaning	The RTP started/stopped.

R002 RTSP PLAY request received [info]

Description	PLAY received: client_IP=%1, num_of_sessions=%2 (R002)
%1	Client IP address <ul style="list-style-type: none"> Displays "HTTP tunneling connection" if the streaming protocol is HTTP tunneling.
%2	Total number of client sessions
Meaning	RTSP PLAY request was received.

R003 RTSP TEARDOWN request received [info]

Description	TEARDOWN received: client_IP=%1, num_of_sessions=%2 (R003)
%1	Client IP address <ul style="list-style-type: none"> Displays "HTTP tunneling connection" if the streaming protocol is HTTP tunneling.
%2	Total number of client sessions
Meaning	RTSP TEARDOWN request was received.

F002 Tracking data transmission start and stop [info]

Description	%1 free-d message output IP: %2 (F002)
%1	start stop
%2	Destination IP address
Meaning	Tracking data transmission started/ stopped.

■ NDI|HX notification

P001 Starting and stopping of NDI|HX [info]

Description	%1 NDI HX (P001)
%1	starting stopping
Meaning	The NDI HX started/stopped.

■ SRT notice

T001 SRT startup and stop [info]

Description	%1 SRT (T001)
%1	starting stopping
Meaning	SRT started/stopped.

T002 SRT delivery start [info]

Description	start SRT stream: IP=%1 (T002)
%1	Destination IP address
Meaning	SRT delivery started.

T003 SRT delivery stop [info]

Description	stop SRT stream: IP=%1 (T003)
%1	Destination IP address
Meaning	SRT delivery stopped.

■ Output Tracking Data notice

F001 Output Tracking Data function start and stop [info]

Description	%1 freed (F001)
%1	starting stopping
Meaning	Output Tracking Data function started/ stopped.

Restoring to the Factory Default Settings

If the settings have been forgotten and want to set the camera from the beginning, restore the factory default settings first. It is recommended to use [System] > [Maintenance] > [Backup/Restore] on the Settings Page to create a backup file before restoring the factory default settings (P. 84).

Important

If restored to the factory default settings, the camera will be unable to connect because the administrator account is also initialized. Use the Camera Search Tool to configure the initial settings.

Note

For the factory default settings, refer to P. 104.

Restoring to the Initial Settings from a Web Browser

Use [System] > [Maintenance] > [General] > [Initialization] > [Network Settings and Management Information] > [Do not save] on the Settings Page (P. 82).

Restoring to the Factory Default Settings with the RESET Switch on the Camera

If the IP address or the Administrator password on the camera is forgotten, operating the camera via the network is not possible. In this case, press the RESET switch to reset the camera.

1 Turn the camera off.

The camera does not have a power switch. In order to turn the camera on or off, connect or disconnect the power supply cable.

2 Turn on the power while pushing the RESET switch, confirm that the POWER lamp lights up (green), and then release the RESET switch after about five seconds.

The RESET switch is located in a recessed area. Push the switch using the tip of a pointed object such as a clip. When the POWER lamp stops blinking (green), the reset procedure is complete.

N500

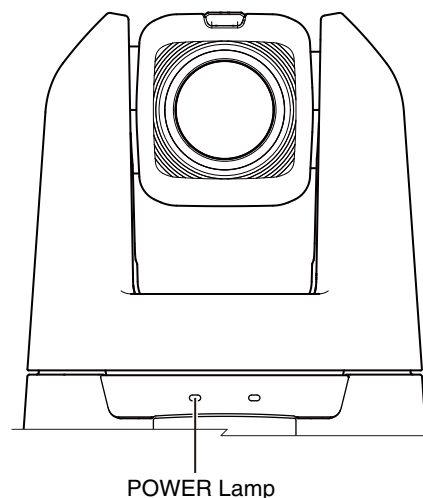
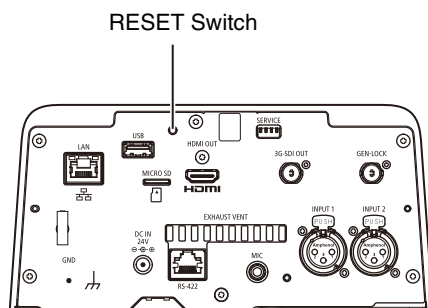

N300

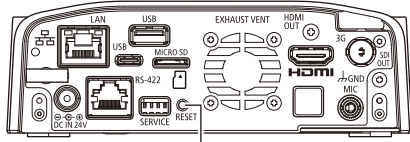

RESET Switch

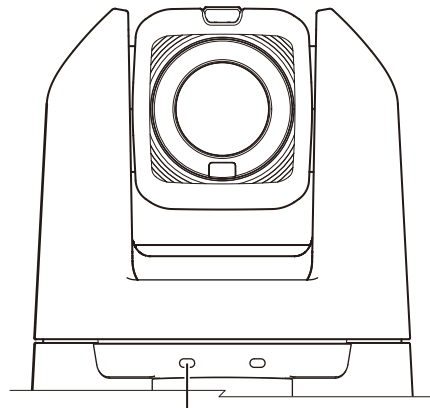

POWER Lamp

List of Factory Default Settings

Item	Factory Default Settings
<ul style="list-style-type: none"> Exposure 	
Shooting Mode	Full Auto
ND Filter N500	Off
Flicker Reduction	Off
Auto Slow Shutter N300	On
<ul style="list-style-type: none"> WB/Color 	
White Balance:R Gain	0
White Balance:B Gain	0
Color Matrix:Gain	0
Color Matrix:R-G	0
Color Matrix:R-B	0
Color Matrix:G-R	0
Color Matrix:Phase	0
Color Matrix:G-B	0
Color Matrix:B-R	0
Color Matrix:B-G	0
<ul style="list-style-type: none"> Image Quality 	
Image Quality Mode N500	Normal1:BT.709
Gamma	Normal1 (Standard)
Color Space	BT.709 Gamut
Color Matrix	Video
<ul style="list-style-type: none"> Image Quality Details 	
Sharpness:Level	0
Sharpness:Limit	0
Noise Reduction	Auto
Black:Master Pedestal	0
Black:Master Black Red	0
Black:Master Black Blue	0
Black Gamma:Level	0
Black Gamma:Range	0
Black Gamma:Point	0
Knee:Activate	On
Knee:Automatic	On
Knee:Saturation	0
<ul style="list-style-type: none"> Focus 	
Focus Mode	AF
AF Frame Size N500	Auto
Face Detection AF	Face Det. & Tracking
AF Speed	Normal

Item	Factory Default Settings
AF Response	Normal
Focus Limit	Off
<ul style="list-style-type: none"> PTZ/IS 	
Digital Zoom	Off
Soft Zoom Control N300	Off
Pan/Tilt Acceleration	Medium
Image Stabilizer	Standard

System

Item	Factory Default Settings
<ul style="list-style-type: none"> HDMI/SDI 	
Video Output Configuration	1920x1080/59.94P
<ul style="list-style-type: none"> SDI 	
3G-SDI Mapping	Level A
<ul style="list-style-type: none"> Mainstream 	
Video Codec	H.264
Video Size	1920x1080
Framerate (fps)	59.94
Bit Rate Control	VBR
Target Bit Rate (Mbps)	20
I Frame Interval (sec.)	1.0
<ul style="list-style-type: none"> Substream1 	
Video Codec	H.264
Video Size	640x360
Framerate (fps)	29.97
Bit Rate Control	VBR
Target Bit Rate (Mbps)	6
I Frame Interval (sec.)	1.0
<ul style="list-style-type: none"> Substream 2 	
Video Codec	JPEG
Video Size	1280x720
Framerate (fps)	14.99
<ul style="list-style-type: none"> General Audio 	
Audio Input	Enable
Audio Input Mode	MIC Terminal/LINE
Input Volume	50
<ul style="list-style-type: none"> IP Audio Streaming 	
Distribution Bit Rate (kbps)	128

Item	Factory Default Settings
<ul style="list-style-type: none"> HTTP Server <ul style="list-style-type: none"> Authentication Method HTTP Port HTTPS Port Video Server <ul style="list-style-type: none"> Maximum Number of Clients Maximum Connection Time (sec.) 	<ul style="list-style-type: none"> Digest Authentication 80 443 15 0
<ul style="list-style-type: none"> RTP Server <ul style="list-style-type: none"> RTP RTSP Authentication Method RTSP Port Audio Settings <ul style="list-style-type: none"> Audio Compression Method Multicast Address Multicast Port Multicast TTL RTP Mainstream <ul style="list-style-type: none"> Video Type Multicast Address Multicast Port Multicast TTL Audio Transmission RTP Substream 1 <ul style="list-style-type: none"> Video Type Multicast Address Multicast Port Multicast TTL Audio Transmission RTP Substream 2 <ul style="list-style-type: none"> Video Type Multicast Address Multicast Port Multicast TTL Audio Transmission 	<ul style="list-style-type: none"> Enable Digest Authentication 554 AAC-LC 48kHz 0.0.0.0 0 1 H.264 1920x1080 0.0.0.0 0 1 Enable H.264 640x360 0.0.0.0 0 1 Enable JPEG 1280x720 0.0.0.0 0 1 Enable
<ul style="list-style-type: none"> LAN <ul style="list-style-type: none"> Maximum Packet Size IPv4 <ul style="list-style-type: none"> IPv4 Address Settings Method AutoIP IPv4 Address (AutoIP) 	<ul style="list-style-type: none"> 1500 Auto (DHCP) Enable -

Item	Factory Default Settings
<ul style="list-style-type: none"> IPv6 <ul style="list-style-type: none"> IPv6 Auto (RA) Auto (DHCPv6) IPv6 Address (Manual) Prefix Length IPv6 Default Gateway Address IPv6 Address (Auto) DNS <ul style="list-style-type: none"> Name Server Address 1 Name Server Address 2 Set Name Server Address Automatically Host Name Search Domain Search Domain List mDNS <ul style="list-style-type: none"> mDNS 	<ul style="list-style-type: none"> Enable Enable Enable (Blank) 64 (Blank) - (Blank) (Blank) (Blank) (Blank) Enable
<ul style="list-style-type: none"> Interface <ul style="list-style-type: none"> Wireless LAN 	<ul style="list-style-type: none"> Disable
<ul style="list-style-type: none"> Standard Communication (IP) <ul style="list-style-type: none"> Standard Communication (IP) Response Port Number Command Response Method Camera IP Settings Inquiry Camera IP Settings Network Settings NDI HX <ul style="list-style-type: none"> NDI HX RTMP <ul style="list-style-type: none"> RTMP Output Tracking Data <ul style="list-style-type: none"> Output Tracking Data SRT <ul style="list-style-type: none"> SRT 	<ul style="list-style-type: none"> Enable Specified Port Number (52381) Use Source Port Number Allow Do Not Allow Disable Disable Disable Disable
<ul style="list-style-type: none"> Serial Port <ul style="list-style-type: none"> Serial Port Serial Port Connection Type Baud Rate (bps) Data Length (bit) Start Bit (bit) Stop Bit (bit) 	<ul style="list-style-type: none"> Enable RS422 9600 8 1 1

Item	Factory Default Settings
Parity	None
• Standard Communication (Serial)	
Standard Communication (Serial)	Enable
Serial Device Address	Auto
• Server Certificate Management	
Server Certificate	(Blank)
Server Certificate Password	(Blank)
Server Certificate List	(Blank)
• Create Certificate	
Country (C)	(Blank)
State/Province (ST)	(Blank)
Locality (L)	(Blank)
Organization (O)	(Blank)
Organizational Unit (OU)	(Blank)
Common Name (CN)	(Blank)
Validity Period Start Date	(Blank)
Validity Period End Date	(Blank)
• Encrypted Communications	
HTTPS Connection Policy	HTTP and HTTPS
• Server Certificate	
Server Certificate	(Blank)
• Administrator Account	
Administrator Name	(Blank)
Password	(Blank)
Confirm Password	(Blank)
• Authorized User Account	
User Name	(Blank)
Password	(Blank)
Confirm Password	(Blank)
User List	(Blank)
• User Authority	
Authorized User	Camera Control <input checked="" type="checkbox"/>
	Video Distribution <input checked="" type="checkbox"/>
Guest User	Camera Control <input checked="" type="checkbox"/>
	Video Distribution <input checked="" type="checkbox"/>
• IPv4 Host Access Restrictions	
Apply Host Access Restrictions	Disable
• IPv6 Host Access Restrictions	
Apply Host Access Restrictions	Disable
• Camera Name	
Camera Name	Camera

Item	Factory Default Settings
• Installation Conditions	
Video Flip	Disable
• Tally Lamp	
Tally Lamp Control	Enable
Tally Lamp Brightness	Medium
• IR Remote Controller	
IR Remote Controller	Enable
• Genlock N500	
Genlock	Disable
• Current Date and Time	
• Settings	
Settings Method	Set manually
Time Zone	(GMT+09:00) Osaka, Sapporo, Tokyo
Daylight Saving Time	Disable
• Environment	
Frame Frequency (Hz)	59.94
• Initialization	
Network Settings and Management Information	Save
• Backup/Restore	
Restore Settings	(Blank)
Encryption Password	(Blank)
• Update Firmware	
Restore Default Settings	Do not restore

Routine Maintenance

Before any maintenance, turn off the power.

Cleaning the External Surface

- 1 Wet a soft cloth with water or a mild detergent and lightly wipe off any dirt.
- 2 Wipe with a dry cloth.

Cleaning the Lens

Use a commercial lens cleaner to remove grime on the lens surface.

- Scratches on the lens surface may result in poor video capture.
- Autofocus functionality may be degraded if the lens surface is dusty or dirty.

Specifications

For the latest information on this product (firmware and software, user manuals, operating environment, etc.), refer to the Canon website.

CR-N500 Main Unit

■ Camera

Image Sensor	Type 1.0 (1.0 in.) single-plate CMOS sensor Total pixels: approx. 13.40 megapixels Effective pixels: approx. 8.29 megapixels (3840 x 2160)
Lens	f=8.3 – 124.5 mm, F/2.8 – 4.5, 15x optical zoom, 9-bladed iris diaphragm 35mm equivalent focal length: approx. 25.5 (W) – 382.5 mm (T)
Digital Zoom	20x
Lens Configuration	18 elements in 14 groups (including 2 aspheric elements)
Minimum Focusing Distance	1 cm (0.39 in.) at full wide angle, 60 cm (2.0 ft.) throughout the zoom range
Angle of View	Horizontal: 73.0° (W) – 5.7° (T) Vertical: 45.2° (W) – 3.2° (T)
Shutter Speed	1/3 – 1/2000 sec. (specific values depend on the frame frequency)
Iris	Manual/Automatic aperture
Gain	-6.0 – 33.0 dB
ND Filter	Built-in (Off, 1/4, 1/16, 1/64), motor operated
White Balance	AUTO (AWB), Set A, Set B, preset settings (daylight: 5600 K*, tungsten lamp: 3200 K*), color temperature setting (2000 K – 15000 K), Manual * Color temperatures are given for reference purposes only.
Focus	Focus mode: Manual, AF-boosted MF, Continuous AF, Face AF, Tracking AF type: Dual Pixel CMOS AF, Contrast AF
Gamma	Normal1 (Standard), Normal2 (x4.0), Normal3 (BT.709), Normal4 (x5.0), Wide DR, Canon Log 3
Image Stabilizer	Optical-shift
Min. Subject Illumination	3840 x 2160 : Approx. 1.5 lux (shutter speed 1/30 sec., frame frequency 29.97 Hz, gain 33.0 dB) 1920 x 1080 : Approx. 3 lux (shutter speed 1/60 sec., frame frequency 59.94 Hz, gain 33.0 dB)
Pan and Tilt	Pan operation range: Horizontal $\pm 170^\circ$ Pan operation speed: 0.1° – 100°/sec. Tilt operation range: Vertical -30° – $+90^\circ$ Tilt operation speed: 0.1° – 100°/sec.

■ Server

Video Output Format	SDI	1920 x 1080: 59.94P/59.94i, 50.00P/50.00i/25.00P, 29.97P/23.98P (4:2:2 10 bit) 1280 x 720: 59.94P, 50.00P (4:2:2 10 bit) – Same video format required for SDI and HDMI (cannot select different formats for SDI and HDMI) – When 3840 x 2160 is selected for HDMI, video will not be outputted to SDI.
	HDMI	3840 x 2160: 29.97P, 25.00P, 23.98P (4:2:2 10 bit) 1920 x 1080: 59.94P/59.94i, 50.00P/50.00i/25.00P, 29.97P/23.98P (4:2:2 10 bit) 1280 x 720: 59.94P, 50.00P (4:2:2 10 bit) – Same video format required for SDI and HDMI (cannot select different formats for SDI and HDMI) – When 3840 x 2160 is selected for HDMI, video will not be outputted to SDI.
	IP	Frame Frequency 59.94 Hz 1920 x 1080: 59.94 fps, 29.97 fps, 14.99 fps, 5.00 fps (4:2:0 8 bit) 1280 x 720: 59.94 fps, 29.97 fps, 14.99 fps, 5.00 fps (4:2:0 8 bit) 640 x 360: 59.94 fps, 29.97 fps, 14.99 fps, 5.00 fps (4:2:0 8 bit) Frame Frequency 29.97 Hz 3840 x 2160: 29.97 fps, 14.99 fps, 5.00 fps (4:2:0 8 bit) 1920 x 1080: 29.97 fps, 14.99 fps, 5.00 fps (4:2:0 8 bit) 1280 x 720: 29.97 fps, 14.99 fps, 5.00 fps (4:2:0 8 bit) 640 x 360: 29.97 fps, 14.99 fps, 5.00 fps (4:2:0 8 bit) Frame Frequency 50.00 Hz 1920 x 1080: 50.00 fps, 25.00 fps, 12.50 fps, 5.00 fps (4:2:0 8 bit) 1280 x 720: 50.00 fps, 25.00 fps, 12.50 fps, 5.00 fps (4:2:0 8 bit) 640 x 360: 50.00 fps, 25.00 fps, 12.50 fps, 5.00 fps (4:2:0 8 bit) Frame Frequency 25.00 Hz 3840 x 2160: 25.00 fps, 12.50 fps, 5.00 fps (4:2:0 8 bit) 1920 x 1080: 25.00 fps, 12.50 fps, 5.00 fps (4:2:0 8 bit) 1280 x 720: 25.00 fps, 12.50 fps, 5.00 fps (4:2:0 8 bit) 640 x 360: 25.00 fps, 12.50 fps, 5.00 fps (4:2:0 8 bit) Frame Frequency 23.98 Hz 3840 x 2160: 23.98 fps, 11.99 fps, 5.99 fps (4:2:0 8 bit) 1920 x 1080: 23.98 fps, 11.99 fps, 5.99 fps (4:2:0 8 bit) 1280 x 720: 23.98 fps, 11.99 fps, 5.99 fps (4:2:0 8 bit) 640 x 360: 23.98 fps, 11.99 fps, 5.99 fps (4:2:0 8 bit) – JPEG has one fixed pattern depending on the frame frequency (format is fixed and cannot be selected) Resolution: 1280 x 720 When frame frequency is 59.94/29.97 Hz: 14.99 fps When frame frequency is 50.00/25.00 Hz: 12.50 fps When frame frequency is 23.98 Hz: 11.99 fps
Protocol	XC (Canon's original), RTSP/RTP, NDI HX, RTMP/RTMPS, Standard Communication (Serial), Standard Communication (IP), SRT, free-d	
Preset	Number of presets: Max. 100 (including home position)	

■ Interface

Communication Control	LAN, Wi-Fi, Serial, IR
Network Terminal	LAN x 1, RJ45, 1000Base-T
3G-SDI OUT Terminal	BNC jack (output only) x 1, 0.8 Vp-p/75 Ω, unbalanced SMPTE 424, SMPTE 425, SMPTE ST 299-2 compliant Embedded audio, Time code (VITC/LTC)
GEN-LOCK Terminal	BNC jack x 1, 1.0 Vp-p/75 Ω, input only
HDMI OUT Terminal	HDMI connector x 1, output only
RS-422 Terminal	RJ45 connector x 1

INPUT 1/INPUT 2 Terminals	INPUT (3-pin jack) (pin1: shield, pin2: hot, pin3: cold), 2 sets, balanced Sensitivity (MIC): -60 dBu (Manual volume center, full scale -18 dB)/600 Ω/Att.: 20 dB Sensitivity (LINE): +4 dBu (Manual volume center, full scale -18 dB)/1 kΩ or more Supply Voltage: 48 V DC (Bias resistance: 6.8 kΩ)
MIC Terminal	Ø3.5 mm stereo mini jack (unbalanced, plug-in power supported) Sensitivity (MIC): -72 dBV (Manual volume center, full scale -18 dB)/1 kΩ or more/Att.: 20 dB Sensitivity (LINE): -10 dBV (Manual volume center, full scale -18 dB)/1 kΩ or more Supply Voltage: 2.4 V DC (Bias resistance: 2.2 kΩ)

■ Others

Operating/Storage Environment	Temperature: 0°C – +40°C (+32°F – +104°F) Humidity: 10% – 90% (without condensation)
Power Supply	PoE: PoE+ power supply via LAN connector (IEEE802.3at compliant) – PoE cannot be used External power source: 24 V DC (using included Compact Power Adapter)
Power Consumption	PoE+ Input: Approx. 19.6 W* max. (body only) DC Input: Approx. 18.6 W max. (body only) * Class 4 (25.5 W required) for power supply devices
Dimensions (W x H x D)	Approx. 200 x 269 x 208 mm (7.87 x 10.59 x 8.19 in.) (excluding protrusions)
Weight	Approx. 4.1 kg (9.04 lb.) (body only)
Supported Controllers	Hardware: RC-IP100 Software: Remote Camera Control Application

CR-N300 Main Unit

■ Camera

Image Sensor	Type 1/2.3 (1/2.3 in.) single-plate CMOS sensor Total pixels: approx. 21.14 megapixels Effective pixels: approx. 8.29 megapixels (3840 x 2160)
Lens	f=3.67 – 73.4 mm, F/1.8 – 2.8, 20x optical zoom, 8-bladed circular aperture 35mm equivalent focal length: [4K UHD] approx. 29.3 (W) – 601 mm (T) [Full HD] approx. 30.5 (W) – 627 mm (T)
Digital Zoom	20x
Lens Configuration	12 elements in 10 groups (including 2 aspheric elements)
Minimum Focusing Distance	1 cm (0.39 in.) at full wide angle, 60 cm (2.0 ft.) throughout the zoom range
Angle of View	[4K UHD] Horizontal: 65.6° (W) – 3.6° (T) Vertical: 39.8° (W) – 2.0° (T) [Full HD] Horizontal: 63.5° (W) – 3.4° (T) Vertical: 38.4° (W) – 1.9° (T)
Shutter Speed	1/6 – 1/2000 sec. (specific values depend on the frame frequency)
Iris	Manual/Automatic aperture
Gain	0.0 – 36.0 dB
White Balance	AUTO (AWB), Set A, Set B, preset settings (daylight: 5600 K*, tungsten lamp: 3200 K*), color temperature setting (2000 K – 15000 K), Manual * Color temperatures are given for reference purposes only.

Focus	Focus mode: Manual, Continuous AF, Face AF, Tracking AF type: Hybrid AF, Contrast AF
Gamma	Normal1 (Standard), Normal3 (BT.709)
Image Stabilizer	Optical-shift
Min. Subject Illumination	Approx. 1.5 lux (shutter speed 1/30 sec., frame frequency 59.94 Hz (P (Program AE) shooting mode), auto slow shutter on)
Pan and Tilt	Pan operation range: Horizontal $\pm 170^\circ$ Pan operation speed: 0.2° – 300°/sec. Tilt operation range: Vertical -30° – $+100^\circ$ Tilt operation speed: 0.2° – 180°/sec.

■ Server

Video Output Format	SDI	1920 x 1080: 59.94P/59.94i, 50.00P/50.00i/25.00P, 29.97P/23.98P (4:2:2 10 bit) 1280 x 720: 59.94P, 50.00P (4:2:2 10 bit) – Same video format required for SDI and HDMI (cannot select different formats for SDI and HDMI) – When 3840 x 2160 is selected for HDMI, video will not be outputted to SDI.
	HDMI	3840 x 2160: 29.97P, 25.00P, 23.98P (4:2:2 10 bit) 1920 x 1080: 59.94P/59.94i, 50.00P/50.00i/25.00P, 29.97P/23.98P (4:2:2 10 bit) 1280 x 720: 59.94P, 50.00P (4:2:2 10 bit) – Same video format required for SDI and HDMI (cannot select different formats for SDI and HDMI) – When 3840 x 2160 is selected for HDMI, video will not be outputted to SDI.
	IP	Frame Frequency 59.94 Hz 1920 x 1080: 59.94 fps, 29.97 fps, 14.99 fps, 5.00 fps (4:2:0 8 bit) 1280 x 720: 59.94 fps, 29.97 fps, 14.99 fps, 5.00 fps (4:2:0 8 bit) 640 x 360: 59.94 fps, 29.97 fps, 14.99 fps, 5.00 fps (4:2:0 8 bit) Frame Frequency 29.97 Hz 3840 x 2160: 29.97 fps, 14.99 fps, 5.00 fps (4:2:0 8 bit) 1920 x 1080: 29.97 fps, 14.99 fps, 5.00 fps (4:2:0 8 bit) 1280 x 720: 29.97 fps, 14.99 fps, 5.00 fps (4:2:0 8 bit) 640 x 360: 29.97 fps, 14.99 fps, 5.00 fps (4:2:0 8 bit) Frame Frequency 50.00 Hz 1920 x 1080: 50.00 fps, 25.00 fps, 12.50 fps, 5.00 fps (4:2:0 8 bit) 1280 x 720: 50.00 fps, 25.00 fps, 12.50 fps, 5.00 fps (4:2:0 8 bit) 640 x 360: 50.00 fps, 25.00 fps, 12.50 fps, 5.00 fps (4:2:0 8 bit) Frame Frequency 25.00 Hz 3840 x 2160: 25.00 fps, 12.50 fps, 5.00 fps (4:2:0 8 bit) 1920 x 1080: 25.00 fps, 12.50 fps, 5.00 fps (4:2:0 8 bit) 1280 x 720: 25.00 fps, 12.50 fps, 5.00 fps (4:2:0 8 bit) 640 x 360: 25.00 fps, 12.50 fps, 5.00 fps (4:2:0 8 bit) Frame Frequency 23.98 Hz 3840 x 2160: 23.98 fps, 11.99 fps, 5.99 fps (4:2:0 8 bit) 1920 x 1080: 23.98 fps, 11.99 fps, 5.99 fps (4:2:0 8 bit) 1280 x 720: 23.98 fps, 11.99 fps, 5.99 fps (4:2:0 8 bit) 640 x 360: 23.98 fps, 11.99 fps, 5.99 fps (4:2:0 8 bit) – JPEG has one fixed pattern depending on the frame frequency (format is fixed and cannot be selected) Resolution: 1280 x 720 When frame frequency is 59.94/29.97 Hz: 14.99 fps When frame frequency is 50.00/25.00 Hz: 12.50 fps When frame frequency is 23.98 Hz: 11.99 fps
	USB	Motion JPEG: 1920 x 1080, 1280 x 720, 640 x 360 59.94 Hz: 12.00 fps, 5.00 fps 50.00 Hz: 12.50 fps, 5.00 fps
Protocol	XC (Canon's original), RTSP/RTP, NDI HX, RTMP/RTMPS, Standard Communication (Serial), Standard Communication (IP), SRT, free-d	
Presets	Number of presets: Max. 100 (including home position)	

■ Interface

Communication Control	LAN, Wi-Fi, Serial, IR, USB
Network Terminal	LAN x 1, RJ45, 1000Base-T
3G-SDI OUT Terminal	BNC jack (output only) x 1, 0.8 V _{p-p} /75 Ω, unbalanced SMPTE 424, SMPTE 425, SMPTE ST 299-2 compliant Embedded audio, Time code (VITC/LTC)
HDMI OUT Terminal	HDMI connector x 1, output only
RS-422 Terminal	RJ45 connector x 1
MIC Terminal	Ø3.5 mm stereo mini jack (unbalanced, plug-in power supported) Sensitivity (MIC): -72 dBV (Manual volume center, full scale -18 dB)/1 kΩ or more/Att.: 20 dB Sensitivity (LINE): -10 dBV (Manual volume center, full scale -18 dB)/1 kΩ or more Supply Voltage: 2.4 V DC (Bias resistance: 2.2 kΩ)
USB Terminal	Type-C (USB 3.0) x 1

■ Others

Operating/Storage Environment	Temperature: 0°C – +40°C (+32°F – +104°F) Humidity: 10% – 90% (without condensation)
Power Supply	PoE: PoE+ power supply via LAN connector (IEEE802.3at compliant) – PoE cannot be used External power source: 24 V DC (using included Compact Power Adapter)
Power Consumption	PoE+ Input: Approx. 16.2 W* max. (body only) DC Input: Approx. 15.0 W max. (body only) * Class 4 (25.5 W required) for power supply devices
Dimensions (W x H x D)	Approx. 154 x 178 x 164 mm (6.06 x 7.01 x 6.46 in.) (excluding protrusions)
Weight	Approx. 2.2 kg (4.86 lb.) (body only)
Supported Controllers	Hardware: RC-IP100 Software: Remote Camera Control Application

Accessories

■ Compact Power Adapter

Input Rate	AC 100 to 240 V, 50/60 Hz, 90 VA (AC 100 V) to 120 VA (AC 240 V)
Output Rate	DC 24 V, 1.8 A
Temperature for Use	0°C – +40°C (+32°F – +104°F)
External dimensions (W x H x D)	Approx. 67.5 x 34 x 134 mm (2.66 x 1.34 x 5.28 in.)
Weight	Approx. 290 g (0.64 lb.)

■ IR Remote Controller

Power	DC 3.0 V Battery size AAA x 2 are used.
Reach Distance	Approx. 8 m (26.2 ft.) vertical and horizontal ± 25° (front of light receiver)
Body dimensions (W x H x D)	46.5 x 25 x 159 mm (1.83 x 0.98 x 6.26 in.)
Weight	Approx. 60 g (0.14 lb.)

Operating Environment

■ Settings Page (Computer Environment)

OS	Windows 10 64-bit	macOS 11
CPU	Intel Core i7-4700 or greater	
Memory	8 GB or more	
Web Browser	Microsoft Edge (Chromium), Google Chrome	Safari
Display	Resolution 1920 x 1080 or greater	

- Must be configured to allow use of JavaScript, and web storage
- Only JPEG format is supported for displaying video
- Does not support audio

■ Settings Page (Verified Mobile Devices Environment)

- As of December 2020

OS	iOS 14.2.1, iPadOS 14.2	Android 11, Android 10
Web Browser	Safari	Google Chrome

- Must be configured to allow use of JavaScript, and web storage
- Only JPEG format is supported for displaying video
- Does not support audio

Security Measures

If the camera is connected to a network and used, it may become a target of cyber attacks such as unauthorized access from unintended third parties. Since this camera has a variety of server functions built in, although they can be convenient, there is a risk of being attacked by a third party unless operated with security measures. To completely eliminate all risks is impossible, however, by studying various risk angles and taking measures based on the security policies, it is possible to decrease the risk of cyber attacks.

This section explains the security hardening measures to the camera settings. Refer to this section and implement necessary measures according to the environment under the customer's responsibility, which will lead to safer camera operation. System administrators are advised to read.

Important

To the full extent permitted by laws and regulations, neither Canon Inc. nor any of its subsidiaries or affiliates shall be liable for any losses, direct, incidental or consequential damages, or liabilities that may be incurred as a result of network security incidents such as unauthorized accesses.

The security hardening measures explained in this section are mainly for the cameras, which are a part of an entire system as shown in the figure below. For the entire system's security hardening, measures must be taken according to the customer's network environment and/or purpose of the camera use.

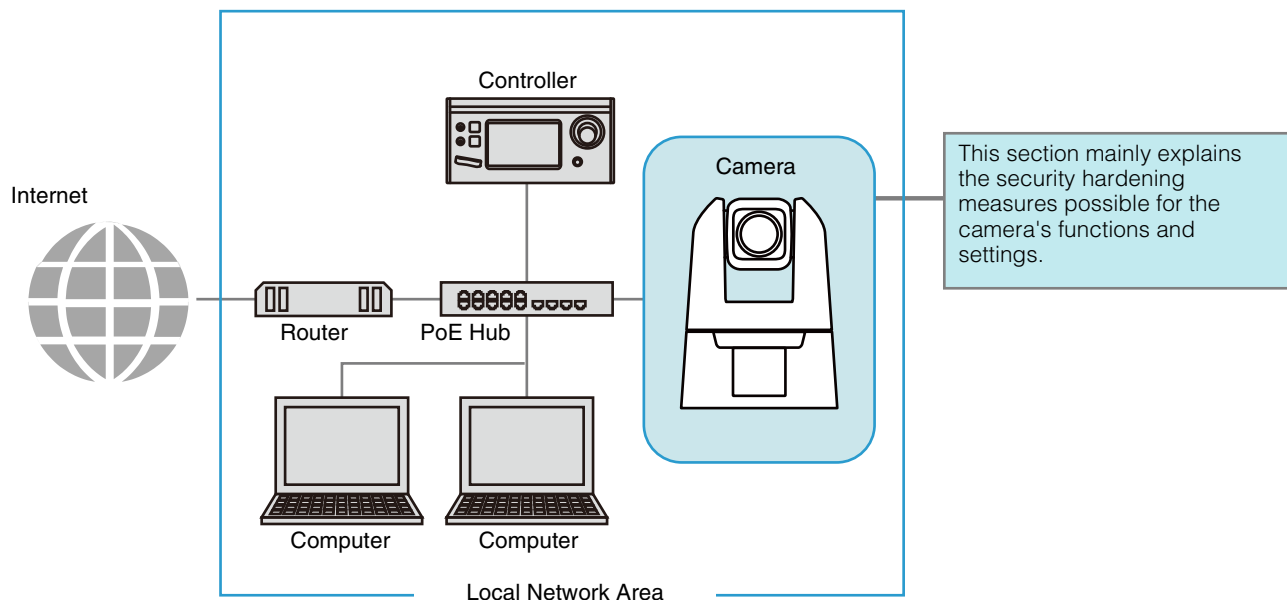

In order to reduce the security risk, it is effective to block access physically and/or virtually if it is unnecessary to be made accessible from an external network, such as the internet.

When access from a remote location is unnecessary and the devices accessing the camera can be limited, using only specific devices in the same local area network will enhance security. When it is necessary to access the camera from a remote location, it is important to use a method that can communicate safely, such as using a VPN (Virtual Private Network) that can block access from the outside.

Basic Measure 1: Setting Administrator Name and Password

The administrator account has authority over all of the camera's settings and operations. If the administrator account is illegally used by an unauthorized party and tampering is done, there is a risk the camera will not be accessible. In order to prevent spoofing of the administrator account, the most fundamental measure for safe operation of the camera is to make the administrator name and password in an array of letters that are difficult to guess by unauthorized users. Strictly manage the administrator account and refrain from settings such as the same administrator account on multiple cameras. The administrator account needs to be set when the camera is started for the first time. After setting, editing can be done on the camera's Settings Page (P. 73).

■ Setting a Strong Administrator Name and Password

In order to strengthen the administrator name and password, consider the following points:

- Combine at least 10 characters of alphanumeric characters or symbols and special characters permitted for the camera.
- Combine upper and lower case characters.
- Avoid commonly used words and string of characters that are easy to guess.

■ Other Passwords

For the camera, in addition to the administrator account, the password for Wireless LAN (P. 62), Server Certificate (P. 70), Authorized User (P. 73), and Encrypting Backup Information (P. 84) are to be set. Set these passwords in an array of letters that are difficult to guess by unauthorized parties and manage them appropriately.

Basic Measure 2: Using the Latest Firmware

The camera's firmware is updated as needed in order to improve performance of the functions and bug fixes. From the security point of view, it is important to always keep it updated because the measures against known vulnerabilities are applied to the latest firmware.

Check Canon's website regularly at the initial setting after purchasing the camera and during its operation, whether the latest firmware is provided.

The firmware version can be confirmed and updated on the camera's Settings Page (P. 82, 85).

Basic Measure 3: Setting Date and Time

Set the correct date and time for the camera. It is recommended to set the time to an NTP server if connected to the Internet. If there are indications that suspicious unauthorized access occurred, it may be possible to confirm the date and time of occurrence by checking the log.

Date and time is set on the camera's Settings Page (P. 78).

Basic Measure 4: Monitoring the Log

Camera connection status and operating conditions are recorded and saved as a log in the camera embedded memory.

Check the logs periodically to quickly find any signs of suspicious unauthorized access, such as repeated user authentication failures. For details on the log, refer to the "List of Log Messages" (P. 95).

The logs will be deleted if any of the following operations are performed: rebooting, initialization, and restoring to the factory default settings.

The log will also be deleted if exceeding a certain size.

The log saved in the camera embedded memory can be confirmed on the camera's Settings Page (P. 86).

Measures Suitable to the Users' Environment 1: User Management

"Administrator", "authorized user", and "guest user" are the three types of accounts that are able to access the camera. The administrator account has authority over all of the camera's settings and operations. Administrator is the only account which is able to access the Settings Page. Therefore, in order to prevent leaks to unauthorized users, it is important to strictly manage information on the administrator account.

The "authorized user" and "guest user" are able to access the camera from such as controllers. Understand what the "authorized user" and "guest user" are able to do, and set the minimum necessary authorization level and users.

"Authorized Users" Means Users Who Require Authentication

To allow only specific users, except the administrator, to control the camera and distribute the video, set up an authorized user. In the authorized user settings, register account information (user name and password) and grant privileges (allow video distribution only, allow camera control, etc.). The same authority is given to all authorized users, therefore it is necessary to be careful to give authority to authorized users. Regularly review and manage the authorized users, and set the minimum necessary authorization level and users.

It is important to disable all the authorities of the guest users, which is described later, when wanting to restrict access to only authorized users. Unless these are disabled, access from the guest users will not be restricted.

"Guest Users"

Guest user means a guest account which does not need a user name and password. By enabling authorities for the guest users, anyone will be able to access the camera without requiring user authentication. Also, this would allow camera control and video distribution commands without authentication. Therefore, guest users authority should be set only when security is ensured, for example, if used within the network that prohibits the external access, etc., otherwise disable all authority of the guest users.

When allowing access by guest users, grant only the minimum necessary privileges to them, since the same privileges are given to all guest users, just as to all the authorized users.

User management is set on the camera's Settings Page (P. 72).

Measures Suitable to the Users' Environment 2: Host Access Restrictions

By specifying the hosts that can access the camera, the risk of unauthorized access can be reduced.

In order to restrict hosts to access the camera, allow communication with only specified hosts, and prohibit all other communication. Oppositely, there is also the method of prohibiting communication with specified hosts and allowing communication with all others.

Depending on the user's environment, the range of access restriction can be grouped on a network basis, or it can be set for each host. However, if mistakenly setting the administrator's IP address to prohibit communication, access from the administrator to the camera will be prohibited and there will be no other way than to restore to the factory default settings. Caution is needed when setting the access restrictions.

Host access restrictions are set on the camera's Settings Page (P. 74).

Measures Suitable to the Users' Environment 3: Setting to the Digest Authentication

When accessing the cameras via [HTTP Server] and [RTP Server], select [Digest Authentication] for the authentication method. When [Basic Authentication] is selected, the password can be easily leaked to unauthorized parties because the password will be sent on the network without being encrypted.

It is necessary to set the authentication method of the HTTP Server and the RTP Server respectively. Authentication method is set on the camera's Settings Page respectively (P. 56, 57). Confirm that the application supports the Digest Authentication.

Measures Suitable to the Users' Environment 4: Changing the Port Number

It is important to limit unspecified access to prevent unauthorized access to the camera. The port number is an entrance to the communication between the camera and the external device, and a number is set for each communication protocol. A common number is used for the port number and network devices can be connected easily. Thus, there is a risk of it being used for intrusion by unauthorized parties.

In case there is a need to change the port number due to concern of security, make sure that the port numbers are not redundant with those of other communication protocols, and set it within the specified range. If the port number is changed, specify the port number in addition to the IP address in order to access the camera.

Example: Changing the Port Number

When connecting by the HTTPS, set "https://{Camera's IP address}:{Port Number}".

When the HTTPS port number is changed to 10443

https://192.168.100.1:10443

HTTP Port Numbers/HTTPS Port Numbers

HTTP/HTTPS port number is set on the camera's Settings Page (P. 56)

It is also possible to change the following port numbers:

- RTSP Port (P. 57)
- Multicast Port (P. 57)

Measures Suitable to the Users' Environment 5: Encrypting Communication

In order to securely communicate between the camera and the external device, it is recommended that all communication be via HTTPS connection (encrypted communication combining SSL/TLS and HTTP). SSL (Secure Sockets Layer)/TLS (Transport Layer Security) is a technology to encrypt communication on the network and prevent hacking and tampering of communication contents by an unauthorized party. Even if the data is hacked during communication, by encrypting the communication in the proper way, the contents of the data are protected and safety can be secured.

Self-Signed Certificate and Server Certificate

To encrypt communication via HTTPS connection, use a self-signed certificate or a server certificate issued from a CA (Certificate Authority). Self-signed certificates are sufficient to do encryption, however, a warning screen will be displayed in the web browser, and there is a risk of impersonation. Therefore, it is advised to use it in the cases for an operation test and others.

It is recommended to acquire and install a server certificate issued from CA for a full-scale system operation.

Encrypting communications by HTTPS connection is set on the camera's Settings Page (P. 71).



Note

Even setting the HTTPS connection as mentioned above, the video delivered via RTP/RTSP cannot be encrypted (SRT delivery can be encrypted). In order to securely communicate the video to deliver, it is necessary to deal with the whole system.

Measures Suitable to the Users' Environment 6: Disabling Unused Functions

The camera has functions to support various purposes and network environments. However, unless those functions are properly set, there is a risk of unauthorized access from outside parties. In order to use the camera safely, it is also necessary to disable the setting of unused functions.

The following describes the functions that need to be addressed in the operating environment and usage situation, such as enabling only the necessary functions or disabling the functions after the setting is completed.

AutoIP

When [AutoIP] (P. 60) is enabled, even in environments where there is no DHCP server, IPv4 link-local addresses (169.254.xxx.xxx) are assigned to the camera. Therefore, by assigning a computer to the same network as the IPv4 address and using the Camera Search Tool, the camera can be detected and initial settings can be made.

Although [AutoIP] is enabled by factory default settings, it is recommended to disable [AutoIP] when the initial setting of the network is completed so that it will not be used for unauthorized purposes.

mDNS (multicast Domain Name System)

[mDNS] (P. 61) is a function to notify devices on the network of the camera IP address and host name information simultaneously so that the camera can be detected even in an environment without a DNS server.

In the factory default settings, the setting of [mDNS] is enabled, but to prevent unauthorized use by third parties, disable it after the initial network settings are completed.

Wireless LAN

[Wireless LAN] (P. 62) allows users to access and operate the camera directly.

If it is unnecessary to connect the camera to a computer or mobile device using a Wireless LAN, set [Wireless LAN] to [Disable].

RTP (Real-time Transport Protocol)

By using [RTP Server] (P. 57), video and audio data can be delivered to the specified multicast address. It is recommended to set [RTP] to [Disable] when the devices connecting to the camera do not require RTP protocol.

Standard Communication (IP), NDI|HX, RTMP, Output Tracking Data, SRT

When using [Standard Communication (IP)], [NDI|HX], [RTMP], [Output Tracking Data] and [SRT], it is possible to distribute videos using each protocol or operate the camera. (P. 64)

If it is unnecessary to connect the camera to a device using these protocols, set each item to [Disable].



Important

- [Video Distribution] under the [User Authority] (P. 73) is not reflected to the RTP.
- When using NDI|HX, RTMP or SRT, access control is disabled from the [User Management] (P. 72).

Precautions When Disposing the Camera

When disposing the camera, initialize the camera and delete all setting information such as network settings and administrator account.

For camera initialization, refer to Settings Page (P. 82). When disposing the camera, set [Network Settings] to [Do not save]. If unable to access the Settings Page, use the RESET switch on the camera to restore to the factory default settings.

Encrypting Backup Information

The backup information of the camera settings is used when restoring the camera to the user's previously saved settings. It is possible to manage the backup information more securely by setting [Encryption Password] for the backup information. Handle the set password with care.

Backup information encryption is set on the camera's Settings Page (P. 84).

Index

A

Access Point	62
Administrator	72
Administrator Account	73
AE Response	30
AE Shift	29
AF (Auto Focus)	37, 42
AGC Limit	29
Audio	54
Audio Settings (RTP)	57
Authorized User	72
Authorized User Account	73
Auto Slow Shutter	30
Autofocus	37, 42

B

Backup/Restore	84
Bit Rate Control	53
Black	35

C

Camera Name	76
Camera Search Tool	15, 17
Certificate Management	70
Color Matrix	31, 34
Color Space	34
Create Certificate	70

D

Date and Time	78
Device Information	82
Digital Tele-Converter	26
Digital Zoom	26
DNS	60

E

Encrypted Communications	71
Environment	80
Error Log	95
Exposure	27
External Connection (IP)	64
External Connection (Serial)	68

F

Face Detection AF	37, 42
Factory Default Settings	102, 104
Firewall	16
Flicker Reduction	30
Focus	37, 42
Frame Frequency (Hz)	80
Framerate (fps)	52

G

Gain (dB)	29
Gamma	33
General Audio	54
Genlock	77
Guest User	72

H

HDMI/SDI	51
Host Access Restrictions	74
HTTP Server	56

I

Image Quality	33
Image Quality Details	35
Image Quality Mode	33
Image Stabilizer	45
Initial Settings	17
Initialization	82
Installation Conditions	76
IP Audio Streaming	55
IP Streaming Video	52
IPv4 (Wired LAN)	59
IPv4 (Wireless LAN)	62
IPv4 Host Access Restrictions	74
IPv6 Host Access Restrictions	74
IR Remote Controller	77, 87
Iris (Aperture Value)	28
IS (Image Stabilizer)	45

K

Knee	35
------------	----

L

LAN	59
Language	81
Log Messages	95

M

Mainstream	52
mDNS	61
Metering Mode	30
MF (Manual Focus)	40, 44

N

ND Filter	28
NDI HX	64
Network	59
Noise Reduction	35
Notification log	98

O

Operating Environment	113
Output Tracking Data	65

P

Pan	25
Power ON	23
Preset	46
PTZ	45

R

Remote Camera Control Application	15
RESET Switch	102
RTMP	65
RTP Server	57
RTP Stream	58

S

SDI	51
Security Measures	114
Serial Port	68
Server	56
Server Certificate	71
Server Certificate Management	70
Settings Page	21, 23
Sharpness	35
Shooting Mode	27
Shutter Mode	28

Soft Zoom Control	45
Specifications	108
SRT	66
SSL/TLS	71
Standard Communication (IP)	64
Standard Communication (Serial)	69
Standby	23
Substream 1	53
Substream 2	53
System	48

T

Tally Lamp	23, 76
Tilt	25
Troubleshooting	93

U

Update Firmware	85
USB Camera	92
User Authority	73
User Management	72

V

Video Codec	52
Video Server	56
Video Size	52
View Logs	86

W

Warning log	97
WB (White Balance)	31
White Balance Mode	31
Wireless LAN	21, 62

Z

Zoom	25
------------	----

