



Remote Camera

Settings Guide

CR-N700 Firmware ver. 1.4.0

Introduction

Thank you for purchasing a Canon Remote Camera (hereafter referred to as the camera)*.

This camera is for indoor use only.

This "Settings Guide" document explains the camera settings and operations. Read this guide carefully before using the camera to ensure correct use. Also, be sure to read the 'Safety Precautions' of the "Installation Guide/Important Information" included with the camera.

* The cameras described in this document may include models not available in your country and/or region.

For the latest information on this product (firmware and software, user manuals, operating environment, etc.), please refer to the Canon website.

Trademarks

- Microsoft, Windows and Microsoft Edge are trademarks or registered trademarks of Microsoft Corporation in the United States and other countries.
- Windows is legally recognized as the Microsoft Windows Operating System.
- macOS is a trademark of Apple Inc., registered in the U.S. and other countries.
- Safari is a trademark of Apple Inc.
- IOS is a trademark or registered trademark of Cisco in the U.S. and other countries and is used under license.
- The terms HDMI, HDMI High-Definition Multimedia Interface, HDMI Trade dress and the HDMI Logos are trademarks or registered trademarks of HDMI Licensing Administrator, Inc.
- Wi-Fi is a registered trademark of the Wi-Fi Alliance.
- NDI is a trademark or registered trademark of Vizrt NDI AB in the United States and other countries.
- All other company or product names used in this document are trademarks or registered trademarks of their respective holders.



Software License Agreement

For the software license agreement, refer to the text file provided with the software and installer.

Except as expressly permitted by the law in effect in the jurisdiction in which you are located, you shall not reverse engineer the firmware which is contained in this product ("Firmware") and you shall not modify the Firmware. TO THE FULL EXTENT PERMITTED BY APPLICABLE LAW, IN NO EVENT SHALL EITHER CANON, OR CANON'S LICENSORS BE LIABLE FOR ANY DAMAGES WHATSOEVER ARISING OUT OF USING THE FIRMWARE. The Firmware may contain third party software components. Notwithstanding anything contained herein to the contrary, the terms and conditions of such third party software components shall be applied to your usage of the Firmware.

Third Party Software

This camera contains third party software modules. Confirm each module's license conditions in [System] > [Maintenance] > [General] > [Tool] > [See Third Party Software License Conditions] on the Settings Page. The Auto Tracking Application also contains third party software modules. For each module's license conditions, refer to "Third Party Software" on the Auto Tracking Application User Manual.

This product partly contains software of which the source code is provided in accordance with the license.

- (1) Please access <<https://global.canon/en/oss/scd/index.html>> to fill the request form so that you receive an e-mail with the URL to download the source code; or
- (2) Please send us a letter in writing with the following information, so that you receive the source code via postal mail. In case you have chosen this (2), WE MAY CHARGE YOU no more than the cost of performing this distribution.
 - (i) Your Address (Country/Region, ZIP code, Address, Your name) [mandatory]
 - (ii) Your e-mail address (for the purpose of possible communication with us) [optional]
 - (iii) Product Name/Application Name [mandatory]

(iv) Product/Application Software Version [optional]

If you do not specify a version, we will send source code corresponding to the latest version.

– Address:

Open Source Promotion Division, Canon Inc.

30-2, Shimomaruko 3-chome, Ohta-ku, Tokyo 146-8501, Japan

– Please see Privacy Notice at Canon Global <<https://global.canon/en/oss/scd/privacy-notice.html>>

This product is licensed under AT&T patents for the MPEG-4 standard and may be used for encoding MPEG-4 compliant video and/or decoding MPEG-4 compliant video that was encoded only (1) for a personal and non-commercial purpose or (2) by a video provider licensed under the AT&T patents to provide MPEG-4 compliant video. No license is granted or implied for any other use for MPEG-4 standard.

THIS PRODUCT IS LICENSED UNDER THE AVC PATENT PORTFOLIO LICENSE FOR THE PERSONAL USE OF A CONSUMER OR OTHER USES IN WHICH IT DOES NOT RECEIVE REMUNERATION TO (i) ENCODE VIDEO IN COMPLIANCE WITH THE AVC STANDARD ("AVC VIDEO") AND/OR (ii) DECODE AVC VIDEO THAT WAS ENCODED BY A CONSUMER ENGAGED IN A PERSONAL ACTIVITY AND/OR WAS OBTAINED FROM A VIDEO PROVIDER LICENSED TO PROVIDE AVC VIDEO. NO LICENSE IS GRANTED OR SHALL BE IMPLIED FOR ANY OTHER USE. ADDITIONAL INFORMATION MAY BE OBTAINED FROM MPEG LA, L.L.C. SEE [HTTP://WWW.MPEGLA.COM](http://www.mpegla.com)

This product comes with exFAT, a licensed file system technology from Microsoft.

-India only-

This product is not to be disposed of with your household waste. This product should be handed over to a designated collection point. For more information regarding return and recycling of WEEE products, please visit <https://in.canon/en/consumer/web/e-waste> or write to us at cipl.ewaste@canon.co.in

Also, this product including its components, consumables, parts and spares complies with the "E-Waste (Management) Rules, 2022" and prohibits use of lead, mercury, hexavalent chromium, polybrominated biphenyls or polybrominated diphenyl ethers in concentrations exceeding 0.1 % by weight and 0.01 % by weight for Cadmium, except for the exemptions set in Schedule II of the Rules.

Compliance with Applicable Laws/intellectual Property Rights: Please note that your use of this product may subject you to certain laws, rules and regulations, including but not limited to, privacy, wiretapping and intellectual property and publicity laws. Please be sure your use of this product and/or any resulting recordings or footage complies with applicable laws, rules and regulations.

Canon Inc. and its affiliates shall have absolutely no liability with respect to any claims made by third parties that your use of this product does not comply with applicable laws, rules and regulations and any resulting claims brought against you by third parties alleging non-compliance with such laws, or otherwise violates any third party's intellectual property, personal, privacy or proprietary rights as a result of your use of the product. We are also not responsible to you for any liability whatsoever resulting from your use, and/or installation of this product, and/or any loss of any recordings or footage.

Limited Warranty: Please check the in-box materials for more information about the limited warranty that pertains to your product.

Installation: This product should NOT be installed outdoors. You are solely responsible for the proper installation of this product. **To the extent permitted by law, Canon Inc. and its affiliates shall have absolutely no liability to you with respect to any damages or liabilities associated with the improper use of, or the installation of this product, or for any personal injuries sustained by you or any third parties as a result of any such improper use or installation of this product, whether or not the installation of this product was by you, or by any third party.**

Network Security: You are responsible for the network security of this product and its use. **To the extent permitted by law, neither Canon Inc., nor any of its affiliates shall be liable to you for any losses, direct, indirect incidental or consequential damages or liabilities arising from any security breaches of this product and/or for any resulting claims brought against you by third parties as a result of such security breaches due to network security of this product.** You need to take appropriate steps to help avoid security breaches which, depending on a variety of factors, including your network environment, can include, but may not be limited to, the following:

- Use the product in a network secured by a firewall, or other security protocol
- Set passwords at least 8 characters in length, including at least 3 different types of characters, such as upper case, lower case and symbols and numbers
- Change passwords frequently; avoid sharing passwords
- Change the HTTP port number of the product
- Limit access to the product by other network devices
- Restrict those who log in to the network to those who have authorized user name and password
- After accessing the product as an administrator, be sure to close all web browsers
- Use security software – install appropriate software to protect against intrusions and infections that can compromise the security of the product and its use
- If the product is connected to a network that includes personal computers, make sure that the system is not infected with computer viruses or other malicious programs (using a regularly updated antivirus program, antispyware program, etc.)
- Avoid connections that use public lines
- Do not install the product in locations where the unit, cables and other equipment can be easily accessed, damaged or destroyed by persons with malicious intent
- Security risks and guidelines are always evolving; the above list is intended to include potential steps that can be taken to help avoid security breaches and is not all inclusive. Please consult with an information security specialist for further information.

Privacy:

- Do not install this product in areas where people have a reasonable expectation of privacy, including but not limited to, bedrooms, dressing rooms, locker rooms and rest room facilities.
- Some jurisdictions require signage disclosing the existence of camera equipment. Please check your own area's laws for requirements.
- Making audio recordings is heavily regulated and can vary significantly by area. Please check laws in your jurisdiction before making any audio recordings.

User Manuals

Types of User Manuals

The following describes the different camera user manuals.

"Installation Guide/Important Information" (Included)

This describes safety precautions, procedures for installing the camera, and downloading information from the Canon website.

"Settings Guide" (This Guide)

This explains the camera initial settings, other settings on the Settings Page, troubleshooting, and major specifications, etc.

How to Use This Document

The assumed reading format of this document is on a computer screen.

■ Notes

1. Any unauthorized reproduction of this document is prohibited.
2. The contents of this document are subject to change without any prior notice.
3. This document has been prepared with the utmost attention to accuracy. If you have any comments, however, please contact a Canon sales representative.
4. Canon shall assume no liability for any outcome of using this product, notwithstanding items 2 and 3 above.

■ Software Screenshots

The software screenshots samples shown in this document are for illustration only. The screenshots may differ from the actual screens displayed.

Descriptions use sample screens when connected to the CR-N700, with Windows 10 for the operating system and Google Chrome for the web browser.

■ Symbols Used in This Document



Symbol	Meaning
 Caution	Failure to follow the instructions indicated by this symbol may result in property damage other than this product. Be sure to follow these precautions.
 Important	Cautions and restrictions during operation. Make sure to read these carefully.
 Note	Supplementary descriptions and reference information.

Table of Contents

	Introduction.....	2
	Trademarks	2
	Software License Agreement.....	2
	Third Party Software.....	2
	User Manuals.....	5
	Types of User Manuals	5
	How to Use This Document	5
Chapter 1	Before Use	
	Examples of System Configuration.....	11
	Security Checking/Settings	13
	Checking the Firewall Settings (Windows).....	13
	Initial Camera Settings.....	14
	Settings using the Camera Search Tool	14
	Camera's Settings Page from the Web Browser.....	16
Chapter 2	Camera Setup	
	Overview.....	18
	Accessing from a Web Browser	18
	Configuration of the Settings Page	20
	Camera Operation	23
	Operation by Clicking on the Video Display Area or by Slider	23
	Exposure Settings.....	25
	WB Settings	31
	Focus Settings	33
	Autofocus.....	33
	Manual Focus.....	36
	Custom Picture Settings	38
	PTZ/IS Settings	45
	Preset Settings.....	46
	Registering Presets.....	46
	Calling Presets and Speed Specification	47
	Deleting Presets.....	48
	Other Functions	49
	Crop Settings.....	50
	Monitoring Settings.....	51
	OSD Settings	57
	Assistance Settings	60
	System Settings	62
	Screen Configuration	62
	Setting Items	63
	Common Operations.....	63

[System] > [Video and Audio] > [HDMI/SDI]	65
HDMI/SDI Shared.....	65
Crop	66
SDI	66
[System] > [Video and Audio] > [IP Streaming Video].....	67
Mainstream	67
Substream 1.....	68
Substream 2.....	68
[System] > [Video and Audio] > [Audio].....	69
General Audio	69
IP Audio Streaming	70
[System] > [Video and Audio] > [Movement Range]	71
Pan/Tilt	71
[System] > [Server] > [HTTP/Video].....	72
HTTP Server	72
Video Server.....	72
[System] > [Server] > [RTP]	73
RTP Server	73
Audio Settings.....	73
RTP Mainstream, RTP Substream 1, RTP Substream 2.....	74
[System] > [Communication] > [Network].....	75
LAN	75
IPv4	75
IPv6	76
DNS.....	76
mDNS.....	77
[System] > [Communication] > [Wireless LAN]	78
Interface.....	78
Access Point	78
IPv4	79
[System] > [Communication] > [External Connection (IP)].....	80
Standard Communication (IP).....	80
NDI HX	80
RTMP.....	81
Output Tracking Data.....	81
SRT.....	82
[System] > [Communication] > [External Connection (Serial)]	84
Serial Port.....	84
Standard Communication (Serial).....	85
[System] > [Security] > [Certificate Management]	86
Server Certificate Management	86
Create Certificate	86
[System] > [Security] > [SSL/TLS]	87
Encrypted Communications.....	87
Server Certificate	87

[System] > [Security] > [User Management]	88
Administrator Account	89
Authorized User Account.....	89
User Authority	89
[System] > [Security] > [Host Access Restrictions]	90
IPv4 Host Access Restrictions	90
IPv6 Host Access Restrictions	90
[System] > [System] > [Camera]	91
Camera Name.....	91
Installation Conditions.....	91
Camera Control.....	92
Color Bars	92
Tally Lamp.....	92
IR Remote Controller.....	92
Genlock.....	93
Time Code.....	93
[System] > [System] > [Add-On]	95
Add-On Management	95
Information About the Selected Application	96
Auto Tracking Application (Lite)	96
[System] > [System] > [Date and Time].....	97
Current Date and Time.....	97
Settings	97
[System] > [System] > [Environment]	99
Environment	99
[System] > [Maintenance] > [General]	100
Device Information	100
Tool	100
Initialization	100
[System] > [Maintenance] > [Backup/Restore]	102
Backup.....	102
Restore.....	102
[System] > [Maintenance] > [Update Firmware]	104
Device Information.....	104
Update Firmware	104
[System] > [Maintenance] > [Log]	105
View Logs.....	105

Chapter 3

IR Remote Controller

Names and Functions of Parts	107
Handling the Remote Controller	109

Chapter 4

Appendix

Troubleshooting.....	111
List of Log Messages	113
Log Messages on the Camera.....	113
Error Log	113

Warning log.....	116
Notification log.....	119
Restoring to the Factory Default Settings.....	124
Restoring to the Initial Settings from a Web Browser.....	124
Restoring to the Factory Default Settings with the RESET Switch on the Camera.....	124
List of Factory Default Settings.....	126
Routine Maintenance.....	131
Cleaning the External Surface.....	131
Cleaning the Lens.....	131
Specifications.....	132
CR-N700 Main Unit.....	132
Accessories.....	135
Operating Environment.....	135
Security Measures.....	136
Basic Measure 1: Setting Administrator Name and Password.....	137
Basic Measure 2: Using the Latest Firmware.....	137
Basic Measure 3: Setting Date and Time.....	137
Basic Measure 4: Monitoring the Log.....	137
Measures Suitable to the Users' Environment 1: User Management.....	138
Measures Suitable to the Users' Environment 2: Host Access Restrictions.....	138
Measures Suitable to the Users' Environment 3: Setting to the Digest Authentication.....	138
Measures Suitable to the Users' Environment 4: Changing the Port Number.....	139
Measures Suitable to the Users' Environment 5: Encrypting Communication.....	139
Measures Suitable to the Users' Environment 6: Disabling Unused Functions.....	139
Precautions When Disposing the Camera.....	140
Encrypting Backup Information.....	140
Index.....	141

Chapter 1

Before Use

This chapter explains the software related to the camera and examples of system configuration. It also describes the preparation and settings after installing the camera.

Examples of System Configuration

System Layout

This camera can be used by connecting with the following devices.

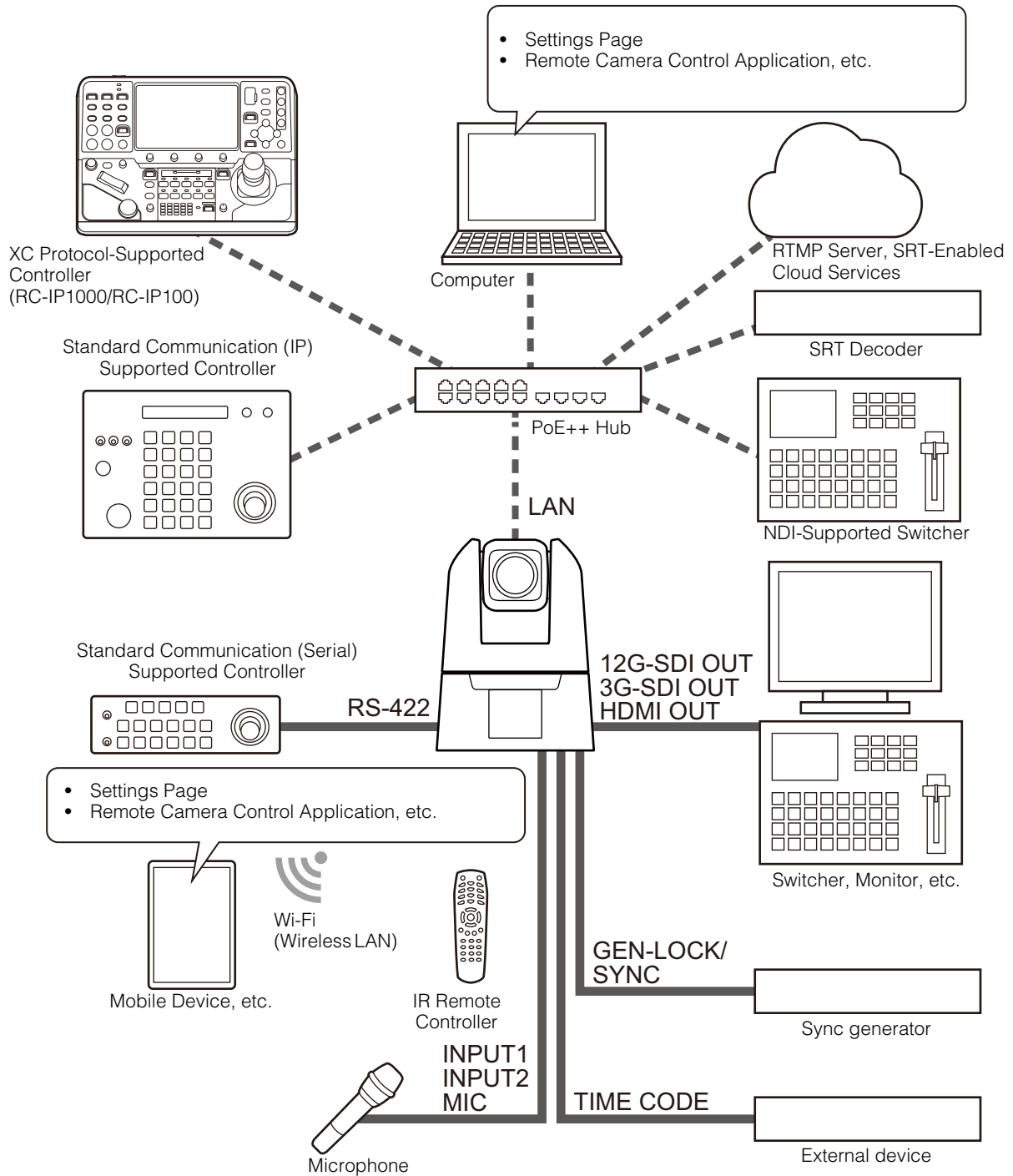

Note

For details on IR remote controller, refer to "Chapter 3 IR Remote Controller" (P. 106).

System Layout Example 1

The following is an example of a connection in which a network connected controller controls multiple cameras and outputs SDI.

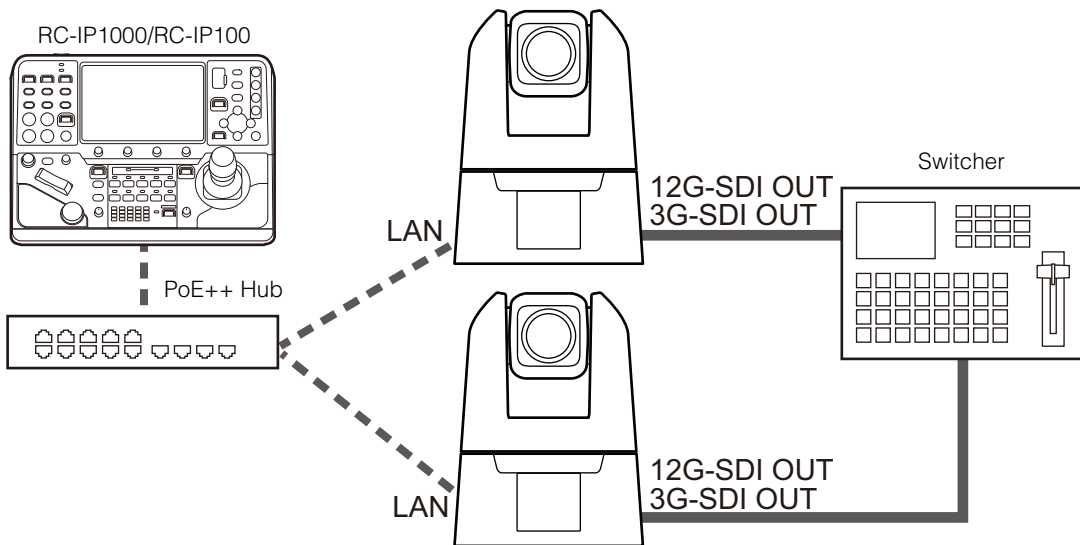

System Layout Example 2

The following is an example of network connected camera control using application.

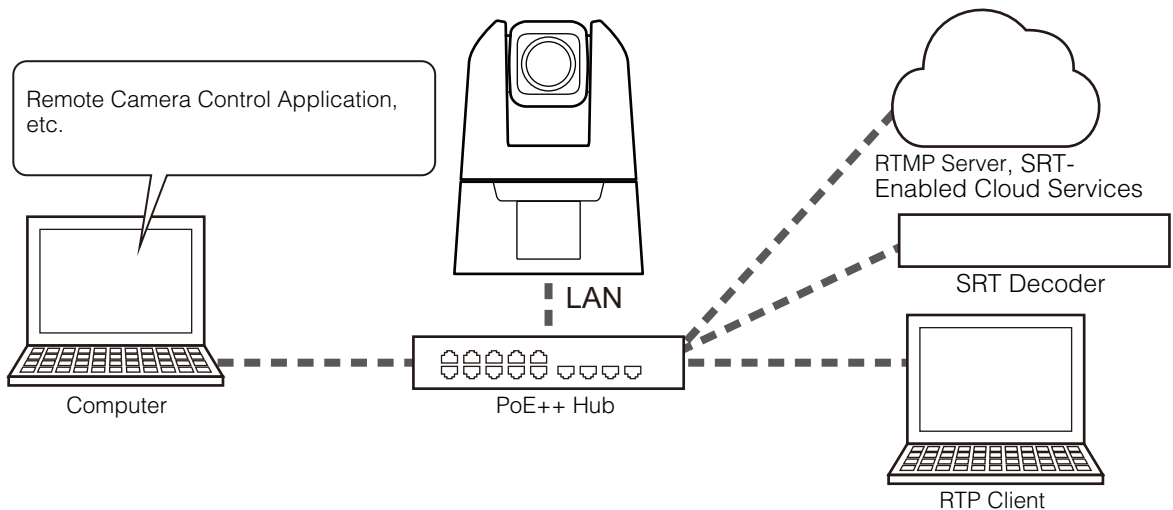

System Layout Example 3

The following is an example with no network connection. Even if network communication is not used during shooting, it is necessary to connect to the network beforehand and perform the initial settings from the computer.

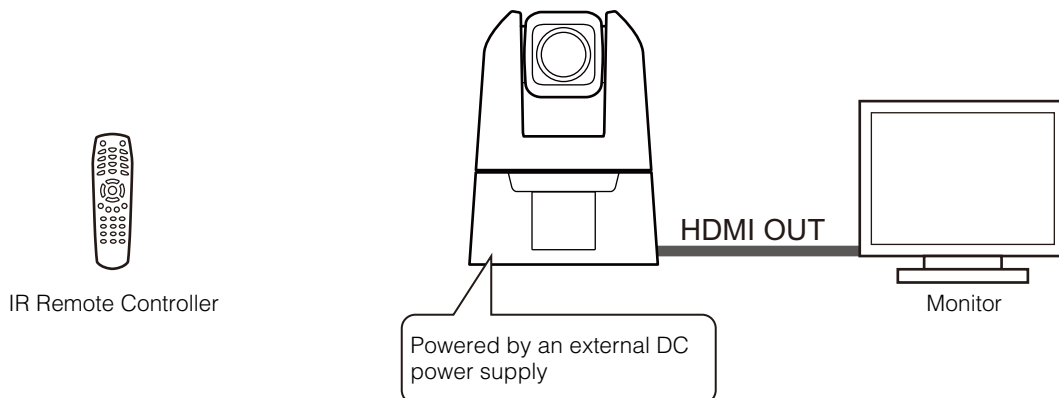

Security Checking/Settings

The security function of the OS or web browser may block the setting and operation of the camera. Check the security settings beforehand, and change the settings if required.

Checking the Firewall Settings (Windows)

To use the software on a computer with Windows Defender Firewall enabled, it is necessary to add each piece of software as an application that allows communication through the firewall.



Note

If applications were not added in this procedure, they can still be added as allowed applications in the [Windows Security Alert] dialog that appears when starting the software.

- 1** Click [Windows Defender Firewall] in [Control Panel] > [Systems and Security].
- 2** Click [Allow an app or feature through Windows Defender Firewall].
- 3** Click [Change Settings] > [Allow another app].
- 4** Select [CameraSearchTool.exe] downloaded from homepage, and click [Add].

Initial Camera Settings

In order to use the camera, it is necessary to first connect the computer to the camera via network then complete the initial setup, including setting the Administrator Account.

This section explains how to use the Camera Search Tool and how to open the camera's initial settings screen directly on a web browser. Use the Multi-Camera Management Application to perform the initial settings for multiple cameras. For details, refer to the Multi-Camera Management Application User Manual.

Note

Even if you have not configured the initial settings, HDMI/SDI video is output and can be used for simple operation checks and other tasks as long as a LAN cable is not connected.

Settings using the Camera Search Tool

Use the Camera Search Tool to access the camera's initial settings screen and perform the initial settings for factory-set cameras.

Camera detection by this tool is valid only for cameras in the same network.

- 1 Connect the camera to the computer on the same network, then turn on the power.
- 2 Once downloaded from the Canon website, double click the Camera Search Tool icon.



Windows : CameraSearchTool.exe
macOS : Camera Search Tool.app

When starting this tool, cameras on the same network are automatically detected and the acquired information is displayed in a list.

In the case the camera is not automatically detected, click [Search Camera].

Note

- Even if the network addresses of the computer and the camera are different, if IPv6 of the computer is enabled, the camera will be detected using the IPv6 link-local address.
- If IPv6 is not available, either assign an IPv4 address on the DHCP server or use the AutoIP feature to detect the camera. To use the AutoIP function, after performing the following settings, connect the computer and camera to a network environment without a DHCP server. Each computer and camera will be assigned an IPv4 link-local address of 169.254.xxx.xxx and will belong to the same network, so the camera can be detected.

Windows: Set [Obtain an IP address automatically] in the network settings.

macOS: Set [Configure IPv4] to [Using DHCP] in [System Preferences] > [Network].

- 3 Click the IP address of the camera to be set up

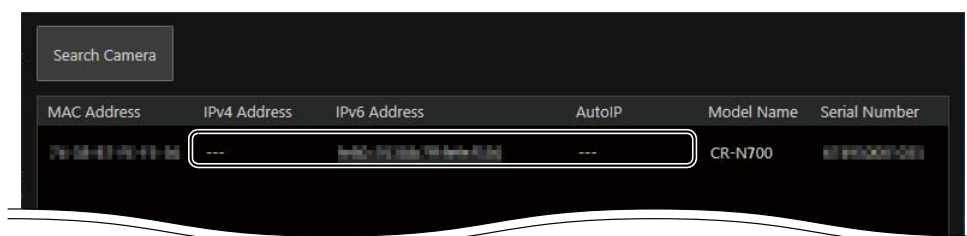

The web browser starts and the [Default Settings (1/2)] screen of the camera is displayed.

- 4 Enter the Administrator Name and Administrator Password, select [Language], and click [Apply and Reboot].

After rebooting the camera, the user name and password input dialog is displayed.



Important

To ensure system security, set the administrator password that should not be easily guessed by third parties. Be sure not to forget the new password.

- 5 Enter the user name (administrator name) and password (administrator password), and click [OK].

The [Default Settings (2/2)] screen of the camera is displayed.

- 6 Set the [Frame Frequency (Hz)], [Maximum Resolution], [Network], and [Date and Time], then click [Apply] or [Apply and Reboot].

After the camera reboots, the Settings Page is displayed and settings are able to be configured.

If the [Network] settings are changed, the camera may be unable to be connected from the operating web browser. In this case, confirm the set network settings and its connected computer then reconnect.

For details on the settings, refer to "System Settings" (P. 62).



Note

- The video size and frame rate options for the output video are determined according to the set frame frequency, and maximum resolution.

7 Repeat steps 3 to 6 to initialize multiple cameras.

To exit the camera search tool, click [Exit] in the menu or click the  button of the window.

Camera's Settings Page from the Web Browser

Able to access the camera by directly specifying the IP address from a web browser.

If there is an IP address assigned by the DHCP server, specify it, otherwise specify "192.168.100.1".



Important

- Able to access with the IP address of 192.168.100.1 approximately 2 minutes after connecting the camera to the network environment.
- If an IPv4 address is assigned by the DHCP server, it will switch to that address and access by 192.168.100.1 will not be possible.
- If there are devices with 192.168.100.1 on the same network, the same IP address will be assigned, and access to the camera with 192.168.100.1 will not be possible.

1 When accessing with 192.168.100.1., set the IP address of the computer.

Set the IP address of the computer to the same network as 192.168.100.1 such as 192.168.100.xxx.

2 Launch the web browser.

3 Enter the camera's IP address in the address column of the web browser and press [Enter].

The [Default Settings (1/2)] screen of the camera is displayed.

4 Perform steps 4 to 6 of the previous section "Settings for the Camera Search Tool".

After the camera reboots, the Settings Page is displayed and settings are able to be configured.



Note

If necessary, restore the computer settings changed in step 1.

Chapter 2

Camera Setup

The settings required to use the camera are made on the Settings Page. Before starting operation, make various settings on the Settings Page according to the shooting conditions and purpose. There are also menus that can be performed during operation, such as camera maintenance.

Overview

Follow the steps below to connect to cameras either by wires or wirelessly and to display the Settings Page.

Accessing from a Web Browser

Follow the steps below to display the Settings Page according to the connection method to the camera (wired or wireless LAN).

Generally, the Settings Page is accessed using a guest user account. For details on the user authority settings, refer to "User Authority" (P. 89).

Important

- In the case the Administrator Account is forgotten, return settings to factory default settings (P. 124). However, because the Administrator Account and other settings will be initialized, it will no longer be able to connect to the camera as it is. Use the Camera Search tool to perform initialization setting.
- To ensure security, close the web browser after completing the settings using the Settings Page.
- Do not open multiple Setting Pages at one time and try to change the settings of a single camera.

■ For Wired LAN

Enter the IP address set in "Initial Camera Settings" (P. 14) directly into the web browser to display the Camera's Settings Page

- 1** Launch the web browser.
- 2** Enter the IP address and press Enter
The Settings Page is displayed.

■ For Wireless LAN

Even when using with a wireless LAN, it is necessary to first connect with a wired LAN and configure the wireless LAN settings.

- 1** Display the Settings Page according to the procedure in the previous section "For Wired LAN"
- 2** Enable wireless LAN.
Click the [System] tab and set [Wireless LAN] to [Enable] in [Communication] > [Wireless LAN], configure [Access Point] and [IPv4], then restart the camera.

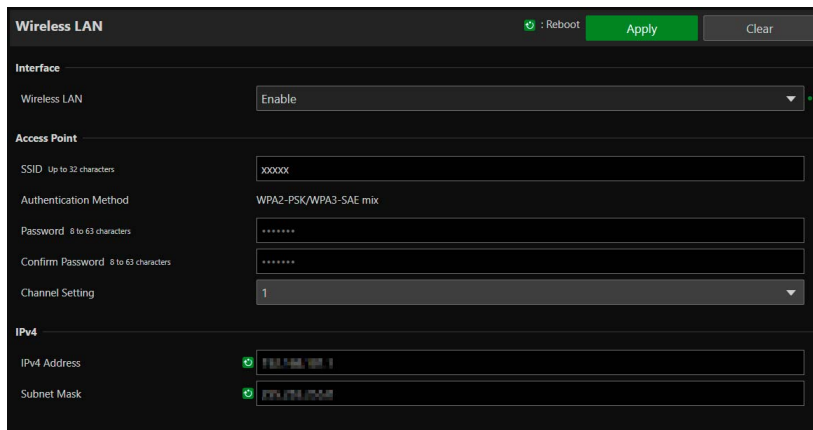

For details, refer to [System] > [Communication] > [Wireless LAN] (P. 78).

3 Connect devices (computers and mobile devices) to be used to the camera

Enable the wireless LAN settings on devices to be used and connect to the access point with the SSID that was configured in step 2.

4 Re-display the Settings Page by following the procedure in the preceding section in "For Wired LAN"

Enter the IP address configured in step 2.

■ Cautions and Troubleshooting for Wireless LAN Connection

If experiencing "Slow down of network speed" or "lost connection" while using a wireless LAN, refer to the following examples.

How to install network devices (Wireless LAN support)

- When using a wireless LAN indoors, install the camera and network device in the same room.
- Install the camera and network device in a location with good visibility, where there is no interference from people or objects.
- Place the camera and network device as close to each other as possible. If necessary, change the installation height and orientation.

Surrounding Electronic Devices

- If the network speed becomes slow due to the influence of nearby electronic devices (radio interference), changing the channel may solve the problem.
- IEEE 802.11 b/g/n wireless LANs use the same 2.4 GHz frequency band as microwave ovens, cordless phones, wireless microphones, and Bluetooth devices. This slows down the network speed if these devices are in the vicinity.
- If an access point that uses the same frequency band as the camera is operating nearby, the network speed will be slower.

Using Multiple Cameras

- Do not duplicate IP addresses of devices in the same network.
- To reduce radio interference, set a four-channel interval for the wireless LAN, for example, "1, 6, 11", "2, 7, 12", or "3, 8, 13".

Configuration of the Settings Page

The configuration of the Settings Page is as follows:

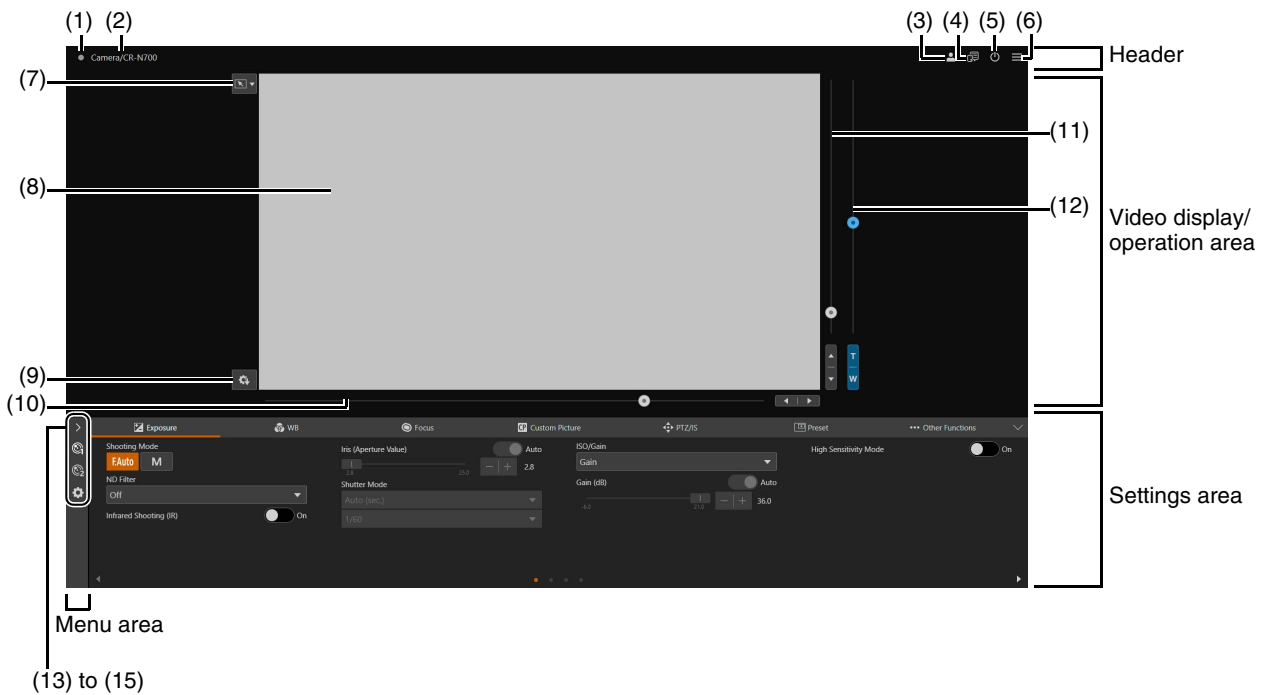

Settings area (When [Camera Control 1] is selected)

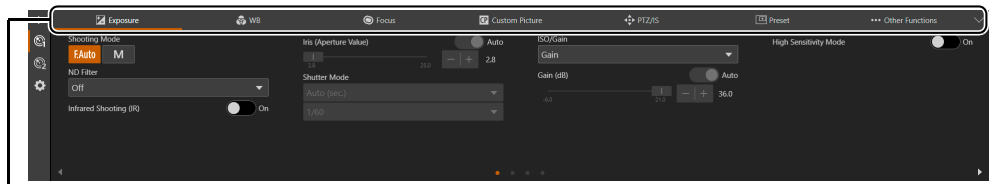

(16) to (22)

Settings area (When [Camera Control 2] is selected)

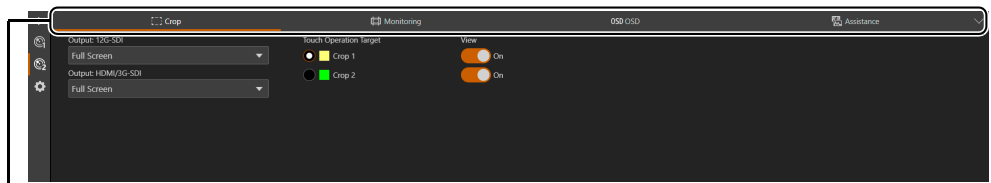

(23) to (26)

Header

This area is common to all Settings Pages.

(1) Tally Lamp Status Display

Displays the video distribution status on the Tally Lamp.

- : Distributing
- : Preparing for distribution
- : No distribution

(2) Camera Name / Model Name

Displays the camera name and the model name of the connected camera.

(3)  **Switch Account**

Switch the account used to access the camera. To access the camera as a guest, check [Guest User].

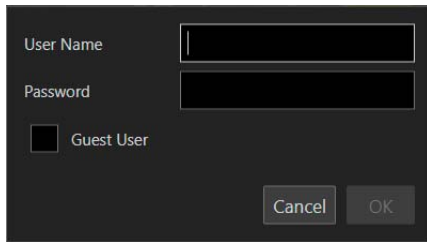

(4)  **Select Language**

Set the language to be displayed on the Settings Page

(5) **Power ON/Standby**

Switches between the camera on and standby mode. Set it to standby mode if required to stop HDMI/SDI output or IP distribution of videos.

If  is clicked while the camera is on, "This will switch to standby. Do you want to continue?" message will appear. Click [OK] and "On Standby" will appear in the video display area and will go into standby mode. Click [Start Up] to return to the power on state.

The power lamp on the front of the camera is as follows:

On (green): Power on

On (orange): Standby

Blinking (green): Changing to or from standby

(6)  **Menu**

Click to display a list of items in the settings area.

For details of the items, refer to the "Settings Area" (P. 22) and "Menu Area" (P. 22).

When using an account without camera control privileges, only [Video] and [System] can be selected. If [Video] is selected, the settings area and operation area are not displayed (only the video display area is displayed).

Video Display/Operation Area

Displays the video received from the camera. Also, operates the pan, tilt, and zoom of the camera.

(7) **Click Operation Menu**

Select the operation performed when clicking on the video display area. Available operations will differ depending on the camera settings.

 [Pan/Tilt]: operates the camera angle (P. 23)

 [Crop]: operates the cropping frame (P. 50).

 [Focus]: focus related operations such as moving the focus frame or tracking (P. 35, P. 37).

 [Off]: no operation.

(8) **Video Display Area**

JPEG video is displayed.

When the image cannot be displayed, the  Reconnect button appears in the center of the screen.

(9)  **Save Preset/Custom Picture**

Save to preset 1 camera settings such as camera angle, exposure, or the currently selected custom picture file. The image at the time of preset registration is saved as a thumbnail. Additionally, save detailed custom picture settings and [Camera Control 2] settings ([Crop], [Monitoring], [OSD], [Assistance]) to the camera.

(10) **Pan Slider (P. 23)**

Move the camera angle left or right. Use the  or  button to fine-tune the position.

(11) **Tilt Slider (P. 23)**

Move the camera angle up or down. Use the  or  button to fine-tune the position.



(12) **Zoom Slider (P. 23)**

Move up to zoom in (telephoto) or down to zoom out (wide angle).

Use the T or W button to fine-tune the position.











■ Menu Area

Display camera settings and shooting assistance function setting items on the settings area, or configure system settings. Click  and select a menu, or click each icon to switch the displayed menu.

- (13)  [Camera Control 1] menu
Sets camera related settings.
- (14)  [Camera Control 2] menu
Sets shooting assistance settings.
- (15)  [System] menu (P. 62)
Configure advanced camera system settings such as video and audio, server, communications, and security.
If this tab is clicked, the video display/operation area disappears, and the screen will be configured with the setting item category and the settings screen.

■ Settings Area







Change camera settings. Select a menu from the left side of the settings area (except for the [System] menu, P. 22), and click each tab to switch the settings area.

- (16)  [Exposure] tab (P. 25)
Sets exposure settings.
- (17)  [WB] tab (P. 31)
Sets the white balance settings.
- (18)  [Focus] tab (P. 33)
Sets focus settings.
- (19)  [Custom Picture] tab (P. 38)
Sets custom picture settings.
- (20)  [PTZ/IS] tab (P. 45)
Sets pan, tilt, and zoom operations and image stabilizer settings.
- (21)  [Preset] tab (P. 46)
Sets the preset settings.
- (22)  [Other Functions] tab (P. 49)
Sets the color bar output and Add-On settings.
- (23)  [Crop] tab (P. 50)
Sets crop related settings.
- (24)  [Monitoring] tab (P. 51)
Sets monitoring settings.
- (25)  [OSD] tab (P. 57)
Sets onscreen displays settings.
- (26)  [Assistance] tab (P. 60)
Sets assistance settings.

Important

Do not use the [Back] and [Forward] buttons on the Web browser to navigate through the settings page. The changed settings may be reverted or unintended changes may be applied.

Note

- By clicking  at the right of the tab area, the Settings area will be hidden, and only the video display/operation area will be displayed.
It will be reverted by clicking .
- If the width of the screen is narrow, tabs can be switched by using the   buttons. Also, for each Settings area, it is possible to switch the display by using the   buttons at the bottom of the screen or by clicking .

Camera Operation

Set the camera angle by operating the camera's pan, tilt and zoom.

Note

Camera control by clicking and dragging does not guarantee exact precision.

Operation by Clicking on the Video Display Area or by Slider

Click and Drag Operation

When the click operation is set to [Pan/Tilt], if you click on the video display area, the camera angle moves so that the position of the mouse pointer is at the center. Also, dragging on the video display area operates the pan/tilt of the camera.

If a single click or drag does not result in the desired camera angle, repeat the operation.

Slider Operation

Dragging the pan and tilt slider knobs pans and tilts the camera.

Drag the zoom slider knob to operate the zoom.

The slider knob moves even if clicking the slider on the point without the knob.



Fine tune the pan, tilt, and zoom positions by clicking the ◀ or ▶, ▲ or ▼, or T or W buttons.

■ Slider Operation When Using the Digital Zoom and Digital Tele-Converter

When [PTZ/IS] > [Digital Zoom] is set to [300x], the digital zoom area is displayed on the zoom slider and digital zoom operation is enabled.

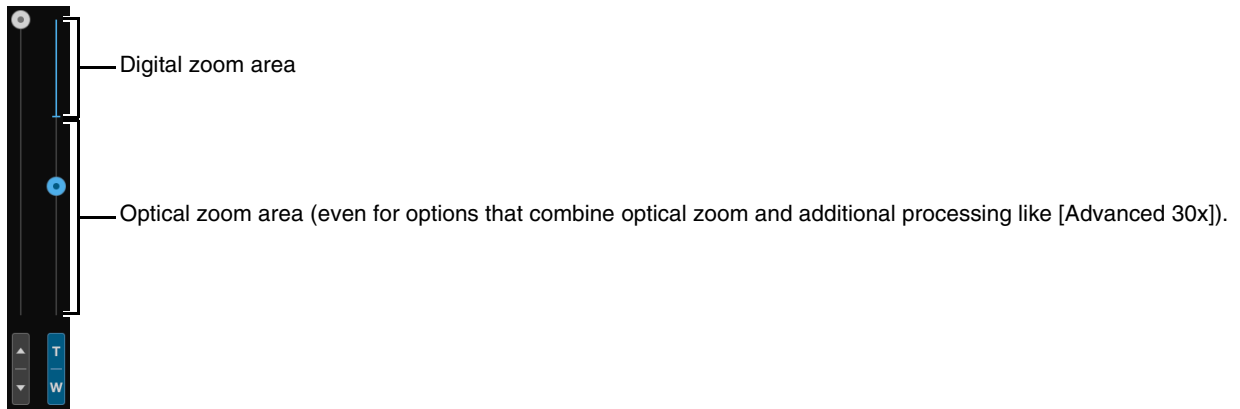

When [PTZ/IS] > [Digital Zoom] is set to [Digital Tele-Converter] (P. 45), the video is magnified according to the magnification selected, but the position of the slider does not change.

Exposure Settings

Settings for the shooting mode according to the shooting environment and subject, as well as the ND filter, infrared shooting, iris, shutter speed, and ISO speed/gain.

To display the [Exposure] tab, select the [Camera Control 1] menu to the left of the settings area.

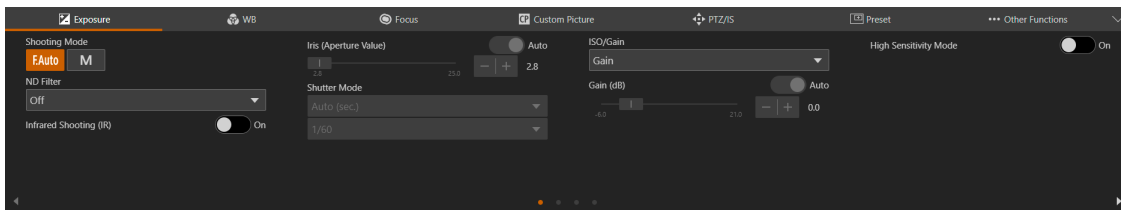

[Shooting Mode]

Switches the shooting mode according to the shooting environment and subject.

F.Auto (Full Auto)

The exposure (iris, shutter speed, ISO speed/gain, etc.) and white balance settings are adjusted automatically.

M (Manual Exposure)

The exposure (iris, shutter speed, ISO speed/gain, etc.) is adjusted manually.

Note

- When the shooting mode is set to **F.Auto** (Full Auto) each setting is set as follows.
 - [Light Metering]: [Standard]
 - [AE Shift]: [± 0]
 - [Limit for Auto Mode] (when set to [ISO]): [ISO12800]
 - [Limit for Auto Mode (dB)] (when set to [Gain]): [21.0 dB]
- The items that can be set differ depending on the shooting mode. The details are shown below.
 - : Items which can be set
 - : Items which are set automatically
 - : Items which cannot be set

Item	Shooting Mode	
	F.Auto	M
ND Filter	○	○
Infrared Shooting* ¹	○	○
Iris	●	○
Shutter Mode	●	○
ISO Speed/Gain	●	○
Limit for Auto Mode	-	○
High Sensivity Mode	○* ²	○* ²
Gain Boost	-	○* ²
AE Shift	-	○* ²
Light Metering	-	○
AE Response	-	○
Shockless Gain	○* ³	○
Iris Limit	○	○
Slow Shutter for IR Shooting	○* ²	○* ²
Iris Increment	○	○
Fine Increment	○* ³	○
Shutter Increment	○	○
ISO Increment/Gain Increment	○	○
Flicker Reduction	○	○
Diffraction correction	○	○

- *1 When set to [On], it is not possible to set shooting mode settings.
- *2 Refer to each item of "Exposure Settings" (P. 25) for the configurable conditions.
- *3 This item can be set, but the settings are not reflected during full auto mode.

[ND Filter]

Choose whether to use the ND filter. ND filter can be switched to three levels (1/4, 1/16, 1/64). The ND filter allows to open the aperture for a video with shallow depth of field even in a bright environment. This is also convenient for avoiding blur caused by narrowing down the aperture.

Note

- About the ND warning: In the following cases, if the ND filter setting is not appropriate, an ND filter indicator (**ND+** or **ND-**) superimposed on the HDMI/SDI output video signal (P. 59) will start flashing.
 - The gain value is too high.
 - The aperture is too closed.
 - The shutter speed is too fast.
 Adjust the [ND Filter] setting until the warning icon disappears to mitigate the effect of such conditions. When **ND+** is flashing, increase the [ND Filter] density (1/4→1/16→1/64). When **ND-** is flashing, reduce the [ND Filter] density (1/64→1/16→1/4).
- Changing the ND Filter settings in certain shooting conditions could generate some slight change in coloring. In this case, it is effective to set the white balance when shooting (P. 31).

[Infrared Shooting (IR)]

Selects whether to perform infrared shooting. Infrared shooting increases the sensitivity to near-infrared light, allowing for shooting in very dark situations.

Important

Depending on usage, shooting in infrared mode may constitute an infringement of privacy and publicity rights, as well as a violation of laws or ordinances.

Note

- When [Infrared Shooting (IR)] is set to [On], the following settings will be limited.
 - [ISO/Gain], [Shutter Mode]: fixed to automatic.
 - [Iris (Aperture Value)]: fixed to open.
 - [ND Filter]: fixed to off.
 - [Limit for Auto Mode]/ [Limit for Auto Mode (dB)], [Light Metering], [AE Shift], [WB], [AF Mode]: cannot be selected.
 - When [Focus] is set to manual and the camera changes to infrared shooting, the autofocus may be activated momentarily and the focus point may change. Check that the focus is correct.
- Depending on the light source, autofocus may not work well while zooming.
- In infrared mode the camera's sensor is considerably more sensitive to near-infrared light. Do not point the lens at strong light or heat sources when infrared shooting is activated.

[Iris (Aperture Value)]

Adjusts the iris (aperture) according to the brightness of the subject.

When [Auto] is set, the iris is automatically adjusted.

When [Auto] is off, the iris can be manually adjusted. Moving the slider to the left opens the aperture and brightens the video. Moving it to the right narrows the aperture and darkens the video.

Following aperture values can be set.

Iris Increment	Iris*
1/3-stop	F2.8, F3.2, F3.5, F4.0, F4.5, F5.0, F5.6, F6.3, F7.1, F8.0, F9.0, F10, F11 (F13, F14, F16, F18, F20, F22, F25, Closed)
1/4-stop	F2.8, F3.2, F3.4, F3.7, F4.0, F4.4, F4.5, F4.8, F5.2, F5.6, F6.2, F6.7, F7.3, F8.0, F8.7, F9.5, F10, F11 (F12, F14, F15, F16, F17, F19, F21, F22, F25, Closed)

* The values in parentheses are only available when [Iris Limit] is set to off.

The aperture value that can be set differs depending on the zoom position. Reference aperture value is displayed on the screen.

Maximum wide angle: F2.8 to F11, maximum telephoto: F4.5 to F11

Note

- By changing the depth of field and blur the background or surroundings to make the subject stand out, set a smaller aperture value, and to keep everything from close objects to far-away objects in focus, set a larger aperture value.

- When shooting in a bright location, narrowing down the iris can cause blurring. It is possible to prevent blurring by adjusting the ND filter and shutter speed and opening the iris.
- When [Auto] of the iris is set to off, the aperture value from Auto is inherited. The aperture value before setting to [Auto] is not restored.

[Shutter Mode]

Adjusting the shutter speed enables to adapt to the subjects and the shooting environment, making it possible to capture fast-moving subjects (sports, vehicles, etc.) clearly and brighten low-light scenes, etc. Shutter speed can be adjusted in the following modes:

[Auto (sec.)]

Automatically adjusts the shutter speed according to the brightness of the video.

[Speed (sec.)]

Sets the shutter speed to seconds. The shutter speed can also be set to a value higher than the frame rate. You can select the increment to use when adjusting the shutter speed between 1/3-stop and 1/4-stop increments.

[Slow (sec.)]

Sets the shutter speed slower than the frame rate to seconds. This setting is used for shooting in low-light areas.

Also, special effects such as "blurring the background" and "adding residual image effects to zoom" are available for shooting a moving subject with pan operation.

For precautions when shooting in slow, refer to "About Shooting with Slow Shutter" (P. 29).

[Clear Scan (Hz)]

Sets the shutter speed by frequency. This is used to reduce black bands on the screen, flickering from fluorescent lighting, and to fine tune the brightness.

[Angle (°)]

You can set the shutter angle to determine the shutter speed.

[Off]

The camera uses a standard shutter speed based on the frame frequency.

The shutter speed that can be selected differs depending on the frame frequency.

Shutter Mode		Frame Frequency (Hz)				
		23.98	29.97	59.94	25.00	50.00
Auto (sec.)		1/24 - 1/2000	1/30 - 1/2000	1/60 - 1/2000	1/25 - 1/2000	1/50 - 1/2000
Speed (sec.)	1/3-stop increments	1/24 - 1/2000	1/30 - 1/2000	1/60 - 1/2000	1/25 - 1/2000	1/50 - 1/2000
	1/4-stop increments	1/24 - 1/2000	1/30 - 1/2000	1/60 - 1/2000	1/25 - 1/2000	1/50 - 1/2000
Slow (sec.)		1/3, 1/6, 1/12	1/4, 1/8, 1/15	1/4, 1/8, 1/15, 1/30	1/3, 1/6, 1/12	1/3, 1/6, 1/12, 1/25
Clear Scan (Hz)		23.98 - 1998	29.97 - 1998	59.94 - 1998	25.00 - 2003	50.00 - 2003
Angle (°)		360°, 240°, 180°, 120°, 90°, 60°, 45°, 30°, 22.5°, 15°, 11.25° Angles equivalent to 1/120 sec., 1/100 sec., 1/60 sec., 1/50 sec., 1/40 sec., 3/100 sec., 1/30 sec. and 1/25 sec. can also be set.				
[Off]		1/24	1/30	1/60	1/25	1/50

Note

- When shooting in a bright location, narrowing down the iris can cause blurring. It is possible to prevent this phenomenon by performing the following operations.
 - Using a denser ND filter (P. 26).
 - Using a faster shutter speed and opening the iris.
- If [Infrared Shooting (IR)] is set to [On], the upper limit for the shutter speed will be 1/250 (when [High Sensitivity Mode] is set to off) or 1/500 (when set to [On]).
- When the shutter mode is set to [Slow (sec.)], bright red, green or blue dots may appear on the screen. In such case, use a faster shutter speed or select a lower ISO speed/gain value (P. 28).

[ISO/Gain]

Able to set the amplification amount of the video amplifier through ISO speed or gain.

When [Auto] is set, the ISO speed or gain is automatically adjusted. By setting the [Limit for Auto Mode] or [Limit for Auto Mode (dB)], the maximum ISO speed/gain can be limited.

When [Auto] is off, manual adjustment is possible. By choosing manual settings you can change the ISO speed/gain values individually.

ISO/Gain	Increments	Available Setting Values*1
[ISO]	1 stop	200, 400, 800, 1600, 3200, 6400, 12800
	1/3 stop	200, 250, 320, 400, 500, 640, 800, 1000, 1250, 1600, 2000, 2500, 3200, 4000, 5000, 6400, 8000, 10000, 12800
[Gain (dB)]	[Normal] (3 dB)	-6.0 dB to 21.0 dB, 36.0 dB*2
	[Fine] (0.5 dB)	

*1 Available values will depend on the gamma curve component of the [Gamma/Color space] setting in the custom picture file.

[Wide DR], [Canon Log 3] or [Canon 709]: ISO 500 to ISO 12800 (-2.0 dB to 21.0 dB).

[PQ] or [HLG]: ISO 320 to ISO 12800 (-6.0 dB to 21.0 dB).

[BT.709 Normal] or [BT.709 Standard]: ISO 200 to ISO 12800 (-6.0 dB to 21.0 dB).

*2 Only when using the [Gain Boost] setting (P. 28).

Note

- Increasing the ISO speed/gain may cause a slightly grainy screen.
- Increasing the ISO speed/gain may cause bright red, green or blue dots to appear on the screen. In such case, use a faster shutter speed (P. 27) or select a lower ISO speed/gain value.
- When the ISO speed or gain level is changed, some noise may appear momentarily on the screen. Do not adjust the ISO speed/gain level while shooting.

[Limit for Auto Mode], [Limit for Auto Mode (dB)]

By limiting the maximum value when the ISO speed/gain is set to [Auto], you can curb the amount of noise and keep a dark ambient.

Adjustment is done in 1/3 stop (1 dB) increments. The adjustable range differs depending on the gamma curve component of the [Gamma/Color Space] setting in the custom picture file.

[Wide DR], [Canon Log 3] or [Canon 709]: ISO 500 to ISO 12800 (-2.0 dB to 21.0 dB).

[PQ] or [HLG]: ISO 320 to ISO 12800 (-6.0 dB to 21.0 dB).

[BT.709 Normal] or [BT.709 Standard]: ISO 200 to ISO 12800 (-6.0 dB to 21.0 dB).

Note

- When the shooting mode is **FAuto** (Full Auto), the [Limit for Auto Mode] or [Limit for Auto Mode (dB)] value will not be applied. It will be limited by the maximum values below.
Maximum ISO 12800 (Maximum 21.0 dB)
- When using [Limit for Auto Mode] or [Limit for Auto Mode (dB)], set the following settings on the Remote Camera Controller.
 - RC-IP100: [AGC Limit]
 - RC-IP1000: [AGC Limit] or [AGC Limit (dB)]

[High Sensitivity Mode]

Using the high sensitivity mode allows for brighter shooting, useful when shooting in dark environments. Can only be set when [ISO/Gain] is set to [Gain]

[Gain Boost]

When set to [On], the gain value will be fixed to 36.0 dB. Can only be set when [ISO/Gain] is set to [Gain] and [Gain (dB)] is set to manual.

Note

- Setting [Gain Boost] to [On] may cause a grainy screen and bright red, green or blue dots to appear on the screen.
- If [ISO/Gain] is set to [ISO] or [Gain (dB)] is set to [Auto], gain boost mode will end.

[AE Shift]

When one of the [Iris (Aperture Value)], [Shutter Mode], [ISO] or [Gain (dB)] is set to auto, the exposure can intentionally be compensated to capture subjects either at a brighter or darker exposure.

Move the slider to a negative value to darken the image, or to a positive value to lighten it.

Adjustment can be made in the range of -2 levels to +2 levels (by 0.25).

[Light Metering]

When one of the [Iris (Aperture Value)], [Shutter Mode], [ISO] or [Gain (dB)] is set to Auto, and the metering mode is set to match the shooting scene, it is possible to shoot with more appropriate brightness.

[Standard]

Meters the entire screen while focusing on the subject in the center of the screen.

[Backlight]

Controls darker areas of the screen more brightly when shooting backlight scenes.

[Spotlight]

Controls the brightness of the subject in the spotlight.

[AE Response]

Select the response of AE when one of the [Iris (Aperture Value)], [Shutter Mode], [ISO] or [Gain (dB)] is set to Auto. The set values are High, Normal, and Low in order of the shortest time to achieve the proper exposure.

[Shockless Gain]

Makes the change in the image look smoother when adjusting the ISO speed/gain level manually.

The setting values that define how long it takes for the ISO speed/gain value to change are High, Normal, and Low in order of speed. When turned off, the change is immediate.

[Iris Limit]

When set to [On], the maximum aperture value (F value) can be limited.



Note

- Using aperture values that exceed the lens's diffraction limit may affect the image (for example, causing diffraction blur). Using aperture values within the lens's diffraction limit (iris limit) is recommended.

[Slow Shutter for IR Shooting]

When set to [On], slow shutter mode is activated during infrared shooting.

[Iris Increment]

Select the iris increment. The F values that can be set differ depending on the selected iris increment.

[Fine Increment]

When set to [On], you can use the smallest iris increment. Nevertheless, the aperture value displayed on the screen will be the closest value in the selected increment scale.

[Shutter Increment]

Selects the shutter increment to use when the shutter mode is set to [Speed (sec.)].

[ISO Increment], [Gain Increment]

Selects the increment to use when adjusting ISO speed/gain.

[Flicker Reduction]

When set to [On], the camera automatically detects and corrects flickering from fluorescent lights.



Note

- Erroneous flicker detection may cause horizontal noise. In this case, avoid using [Flicker Reduction].
- When shooting under an artificial light source such as a fluorescent lamp, mercury lamp, or halogen light, flicker may occur in principle depending on the shutter speed set. It may be possible to suppress flicker by setting the shutter speed according to the frequency of the power supply. For 50 Hz, select 1/50 second* or 1/100 second; for 60 Hz, select 1/60 second or 1/120 second.
* Not available depending on the frame frequency.

[Diffraction correction]

When the aperture is closed down, the image produced may not be as sharp at certain apertures (diffraction). Set this setting to [On] to correct the lack of sharpness caused by diffraction.

■ About Shooting with Slow Shutter

When [Shooting Mode] is set to **M** (Manual Exposure) and [Shutter Mode] is set to [Slow (sec.)], by using a slow shutter speed you can obtain a brighter picture even in dark surroundings. However, the following phenomena may occur depending on the scene and the subject.

- Noticeable residual image from moving subjects

- Deterioration of image quality
- White spots on the screen
- Autofocus not functioning well

WB Settings

Sets the white balance settings.

To display the [WB] tab, select the [Camera Control 1] menu to the left of the settings area.

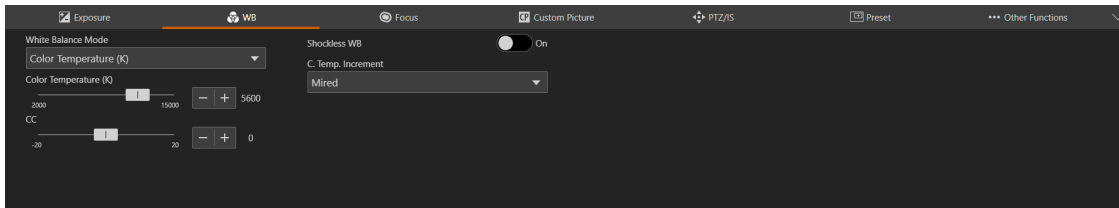

Note

- When [Exposure] > [Shooting Mode] is **F.Auto** (Full Auto), [White Balance Mode] is AWB fixed. When [Exposure] > [Infrared Shooting (IR)] is set to [On], [White Balance Mode] cannot be set.

[White Balance Mode]

Sets white balance according to the color temperature of light sources such as illuminations and daylight. Adjustment procedure is as follows:

[AWB]

Adjust the white balance so that it is always optimal. The white balance is automatically adjusted as the color temperature of the light source changes. By activating [Lock], you can pause [AWB] (auto white balance) mode. The lock will be canceled if a different white balance setting is selected.

[Daylight]

Sets the white balance according to the daylight (approx. 5600 K). The adjustment range is 4300 K to 8000 K. You can further adjust the color compensation* value (± 5 CC).

* Adjusts the color along the green/magenta gradation.

[Tungsten]

Sets the white balance according to tungsten lighting (approx. 3200 K). Use this setting when shooting under tungsten or tungsten colored fluorescent lighting. The adjustment range is 2700 K to 3700 K. You can further adjust the color compensation value (± 5 CC).

[Color Temperature (K)]

Specify the color temperature in range of 2000 K to 15000 K to adjust the white balance. You can further adjust the color compensation value (± 20 CC).

[Manual]

Set [R Gain] and [B Gain] as desired.

[Set A], [Set B]

Executing [White Balance Calibration] captures the reference white color in the actual shooting environment. Illuminate a gray card or white subject (white paper, etc.) with a light source and click [White Balance Calibration] while the subject fills the screen.

Possible to register two settings: [Set A] and [Set B].

The settings are erased after the camera is restarted or turned off/on, so register them as a preset in order to save the settings.

Note

- When shooting under the following conditions, if the screen color looks unnatural in [AWB], adjust the white balance using [Set A] or [Set B]:
 - Shooting in locations where lighting conditions suddenly change
 - Close-up shooting
 - Shooting a scene with only one color, such as sky, sea, or forest
 - Shooting under mercury lamps and certain fluorescent/LED lights
- The [White Balance] and [Color Matrix Tuning] settings in the custom picture file (P. 38) take precedence over the white balance set with these procedures.
- Color temperatures are given for reference purposes only.
- If the setting is other than [AWB], and the location or brightness changes or the ND filter is switched, adjust the white balance again.

[AWB Response]

Selects the responsiveness when [White Balance] is set to [AWB].

The set values in the order of the shortening time required to achieve the proper white balance are High, Normal, and Low.



Note

- When [Exposure] > [Shooting Mode] is set to **F.Auto** (Full Auto), [AWB Response] is [Normal] fixed.

[Shockless WB]

When set to [On], makes the transition look smoother when you change the white balance settings.

[C. Temp. Increment]

Select the units for the color temperature increment between [Mired] (5-mired increments) or [Kelvin] (100-kelvin increments). Even when [Mired] is selected, the color temperature is converted to and displayed in kelvins. Changing this setting may change the white balance setting.

Focus Settings

There are two focus adjustment modes: "Autofocus" and "Manual focus".

Switch the [AF] on in the focus mode to select the autofocus or switch it to off to select the manual focus.

The items that can be set differ depending on the focus mode.

To display the [Focus] tab, select the [Camera Control 1] menu to the left of the settings area.

Autofocus

Autofocus adjusts the focus automatically.

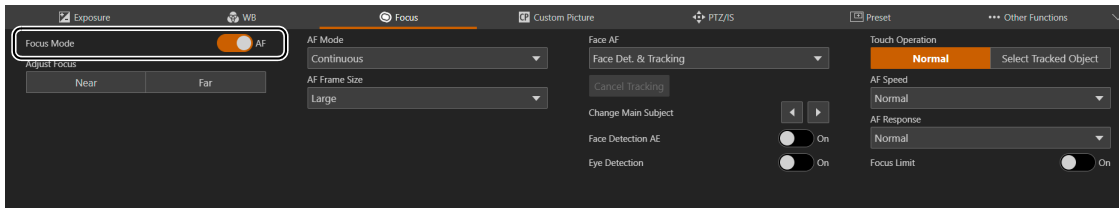

[Focus Mode]

Turning [AF] on switches to autofocus mode.

[Adjust Focus]

Able to adjust the focus manually even when [AF] is set to on.

Click [Near] to move the focus position to the near side, and [Far] to move the focus position to the far side. Click and hold the button to move continuously. Release the button to achieve the focus automatically again.

[AF Mode]

Selects the autofocus mode.

[Continuous]

Always on autofocus.

[AF-Boosted MF]

Click [Near] or [Far] to roughly adjust the focus of the target subject, and it will automatically adjust the focus when the subject approaches the in-focus position.

Use this mode when the video size is large, such as [3840x2160], or when wanting to prevent the focus from becoming less precise during shooting. In addition, since an uncertain adjustment operation is not performed when adjustment information cannot be detected, adjustment can be performed more stably than [Continuous].

[AF Frame Size]

Able to change the size and position of the AF frame displayed on the screen when adjusting with autofocus.

When the AF frame size is set to [Big] or [Small], selecting the position of the AF frame is possible. During face detection or subject tracking, the size and position of the AF frame automatically changes to match the face and subject (P. 35).

[Whole Area]

Focuses on the subject in the center of the screen. No frame is displayed. Only available when [AF Mode] is set to [Continuous].

[Small], [Big]

Focuses on the subject in the AF frame shown. Able to move the AF frame to any position within 80% of the screen (P. 35).

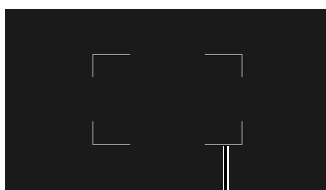

AF frame

[Face AF]

Sets the operation of the face detection AF (the ability to detect and focus on a person's face).

[Off]

Focuses on the AF frame or the center of the screen. Face detection is not performed.

[Face Det. & Tracking]

Gives priority to focus on a person's face.

- When there is a person's face in the screen
When multiple people are in the screen, the main subject is automatically determined.
The following face frame is displayed regardless of the [AF Frame Size] setting.

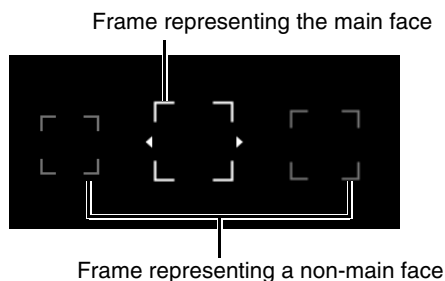

When there is only one face frame, ◀ and ▶ will not be displayed on the frame.

Click on a face frame to track that face (P. 35).

You can change the main subject with the [Change Main Subject] function (P. 34).

- When there is no face in the screen
The [AF Frame Size] setting determines the focus position (P. 35).

[Face Only]

Focuses only on the person's face.

If there is a person's face in the screen, follows the procedure described in the previous section, [Face Det. & Tracking].

If there isn't any person's face in the screen, the focus is locked until a face is detected.

[Cancel Tracking]

Cancels tracking when tracking a specified subject (P. 35).

[Change Main Subject]

Changes the main subject when multiple faces or both eyes have been detected with the [Face AF] and [Eye Detection] functions. Click ◀ to move the face frame/eye frame to the left, or ▶ to move it to the right.

[Face Detection AE]

When set to [On], brightness for the detected face will be adjusted automatically.

[Eye Detection]

When set to [On], the eyes of the person determined to be the main subject will be detected, and a frame will appear on the eyes of the main subject. When both eyes have been detected, you can select either eye using the [Change Main Subject] function (P. 34).

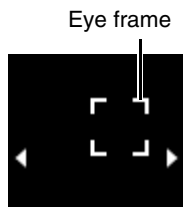

[Touch Operation]

For screen operations, refer to "Clicking on the Screen" (P. 35).

[AF Speed]

Selects the autofocus adjustment speed. The setting values are High, Normal, and Low in order of speed.

[AF Response]

Selects the responsiveness of the autofocus.

The setting values are High, Normal, and Low in order of the shortest time until the focus operation starts.

[Focus Limit]

Reduces the time to achieve the focus by limiting the focus range.

When set to [On], the focus range is limited to 60 cm (2 ft.) to ∞ (throughout the entire zoom range). When set to off, the range is 1 cm (0.39 in.; at full wide-angle) to ∞ , including the macro area.

■ Clicking on the Screen

Click the screen to move the AF frame to that position. Even if a person or subject moves in the screen, it is possible to keep the focus on the main subject. This is called tracking.

When [Face AF] is [Off]

If [AF Frame Size] is [Big] or [Small], the AF frame moves to the point where clicked.

When [AF Frame Size] is set to [Whole Area], the subject in the center of the screen stays in focus and the AF frame will not be displayed.

When [Face AF] is [Face Det. & Tracking]

When clicking on a person's face, a tracking frame appears on the face, and the tracking will be in progress.

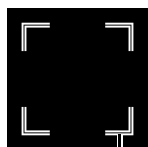

Tracking Frame

If something other than the face of a person is clicked, depending on the AF frame size, the operation differs as follows.

When [AF Frame Size] is set to [Whole Area], the tracking frame appears on the subject clicked on the screen and is tracked.

When [AF Frame Size] is set to [Big] or [Small], and [Touch Operation] is set to [Normal], the AF frame is displayed on the position clicked on the screen when no faces are detected. If faces are detected, the face frame is as displayed.

When [AF Frame Size] is set to [Big] or [Small], and [Touch Operation] is set to [Select Tracked Object], the tracking frame is displayed on the subject clicked on the screen, and tracking is activated.



Note

When the tracking frame is displayed, the face frame will not be displayed.

When [Face Only] is selected for [Face AF]

Clicking a person's face is the same operation as in [Face Det. & Tracking] in the previous section.

If something other than the face of a person is clicked, depending on the AF frame size, the operation differs as follows.

When [AF Frame Size] is set to [Whole Area], the operation is the same as in [Face Det. & Tracking] in the previous section.

When [AF Frame Size] is set to [Big] or [Small], the focus does not change.

■ Autofocus

- The focus position for autofocus varies slightly depending on the shooting conditions such as the subject, brightness, and zoom position. Check the focus again before shooting.
- Focus adjustment can take a while when the frame frequency is 29.97 Hz, 25.00 Hz, or 23.98 Hz.
- The autofocus settings cannot be used in the following cases.
 - When [PTZ/IS] > [Digital Zoom] > [Digital Tele-Converter] is set to [3.0x] or [6.0x]
 - When the gamma curve component of the [Gamma/Color Space] setting in the custom picture file is set to [PQ] or [HLG].
 - When infrared shooting is activated.

- It may be difficult to focus with autofocus in certain cases.

Shooting conditions that are difficult to focus with autofocus

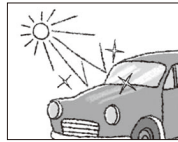

Strong light is reflected.



Center of the screen has little light/dark difference.

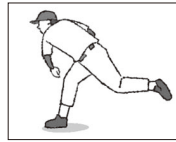

Fast movement

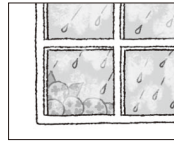

Shooting through glass with water droplets



Night view



Repeated pattern

- When the gamma curve component of the [Gamma/Color Space] setting in the custom picture file (P. 39) is set to an option other than [BT.709 Normal] or [BT.709 Standard].
- When the iris is narrowed down
- When the shutter speed is in the range of [Slow (sec.)]
- When subjects are at both far and near sides
- The following are the main examples of failure to detect faces:
 - When the face is extremely small, large, dark, or bright relative to the entire screen
 - When the face is facing sideways or diagonally, or the face is upside down
 - When part of the face is hidden
- The following are the main examples of failure to detect eyes:
 - Under the same conditions listed as examples of failure to detect faces.
 - When wearing glasses or sunglasses, or when the subject's hair is covering the eyes or the face.
 - When the face is obscured by shadow, or in backlit situations.
- May detect a subject other than a person as a face by mistake. If so, set [Face AF] to [Off].
- May accidentally track another subject with similar characteristics. In this case, select the subject again.
- The conditions under which face detection AF, tracking or eye detection cannot be used are as follows:
 - Shutter speed slower than 1/30 of a second (frame frequency at 59.94/29.97 Hz), 1/25 of a second (at 50.00/25.00 Hz), or 1/24 of a second (at 23.98 Hz).
 - When [PTZ/IS] > [Digital Zoom] is set to [300x] and the image size is magnified by more than 60 times
 - When [PTZ/IS] > [Digital Zoom] > [Digital Tele-Converter] is set to [6.0x]
 - During infrared shooting
- Unable to change the size or position of the AF frame in the following cases:
 - When [PTZ/IS] > [Digital Zoom] is set to [300x] and the zoom position is the digital zoom area.
 - When [PTZ/IS] > [Digital Zoom] > [Digital Tele-Converter] is set to [3.0x] or [6.0x]
 - During infrared shooting
 - When the gamma curve component of the [Gamma/Color Space] setting in the custom picture file is set to [PQ] or [HLG].
- Face detection AE cannot be used in the following cases.
 - When shutter speed, ISO speed/gain and aperture are set to manual.
 - When the light metering mode is set to [Spotlight].

Manual Focus

Manual Focus makes the focus position move manually.

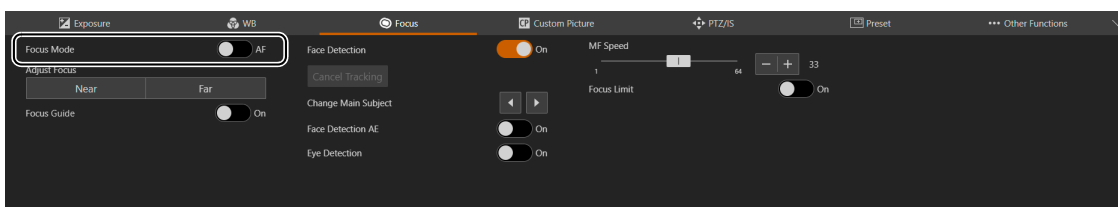

Note

- If a zoom operation is performed after focusing, the focus may shift.
- If the camera is left turned on, the focus may shift due to increase of the temperature of the lens and inside the camera body. Check the focus again before shooting.

[Focus Mode]

Turning [AF] off switches to manual focus mode.

[Adjust Focus]

Click [Near] to move the focus position to the near side, and [Far] to move the focus position to the far side. Click and hold the button to move continuously.

[Focus Guide]

When set to [On], the focus guide frame is displayed and can be moved to the position clicked on the screen.

The focus guide frame visually displays the direction and amount of adjustment from the current focus position to the in-focus position.

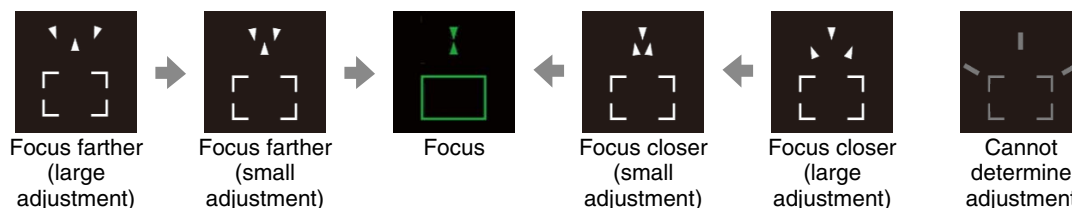

It can also be used in combination with face detection (P. 37) and eye detection (P. 37). When there are no faces on the screen, the focus guide frame can be moved to the clicked position.

The focus guide frame will also be displayed on the image output from the 12G-SDI OUT terminal or HDMI OUT terminal / 3G-SDI out terminal, as well as the IP streaming video.



[Face Detection]

When set to [On], if there are people's faces on the screen, the focus guide frame will be displayed on the face of the person judged to be the main subject.

[Cancel Tracking]

The setting is the same as for "Autofocus" (P. 34).

[Change Main Subject]

Changes the main subject when multiple faces or both eyes have been detected with the [Face Detection] and [Eye Detection] functions. Click  to move the face frame/eye frame to the left, or  to move it to the right.

[Face Detection AE]

The setting is the same as for "Autofocus" (P. 34).

[Eye Detection]

The setting is the same as for "Autofocus" (P. 34).

[MF Speed]

Selects the manual focus adjustment speed (amount of focus movement when [Near] or [Far] is clicked.).

Note

- The green focus guide indicates the focus range.
- When the [Iris (Aperture Value)] is set to [Auto], it may take a while for the response of the focus guide frame to stabilize after a zoom operation.
- In the "Shooting conditions that are difficult to focus with autofocus" (P. 36), the focus guide frame may not be displayed correctly.
- The focus guide is not available if:
 - [PTZ/IS] > [Digital Zoom] is set to [300x] and the zoom position is the digital zoom area.
 - [PTZ/IS] > [Digital Zoom] > [Digital Tele-Converter] is set to [3.0x] or [6.0x]
 - When the gamma curve component of the [Gamma/Color Space] setting in the custom picture file is set to [PQ] or [HLG].
 - During infrared shooting
- The face detection is not available if:
 - Shutter speed slower than 1/30 of a second (frame frequency at 59.94/29.97 Hz), 1/25 of a second (at 50.00/25.00 Hz), or 1/24 of a second (at 23.98 Hz).

[Focus Limit]

The setting is the same as for "Autofocus" (P. 35).

Custom Picture Settings

Sets custom picture settings. By using custom picture settings, you can change many settings that control various aspects of the image produced. After adjusting the desired settings to your preference, you can save them as a custom picture file and load them later to apply exactly the same settings. You can save up to 20 custom picture files to the camera. To display the [Custom Picture] tab, select the [Camera Control 1] menu to the left of the settings area.

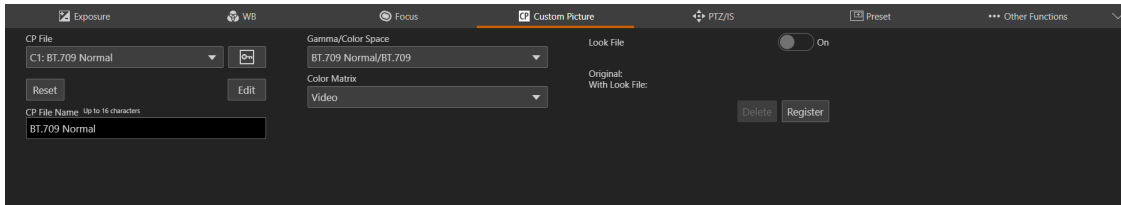

[CP File]

Select a custom picture file to apply its settings. By saving custom picture files to the camera, it is possible to easily select the desired image quality adjustments from the list of custom picture files. When editing/saving, renaming or protecting custom picture files, select the desired custom picture file in the same way.

The following settings are saved to custom picture files C1 to C20 as preset custom picture settings. Custom picture files C1 to C9 are protected by default and need to be unprotected before they can be edited.

Preset custom picture file	[Gamma/Color Space]	[Color Matrix]	Look Files	Characteristics
C1:BT.709 Normal	BT.709 Normal / BT.709	Video	–	These settings are appropriate for playback on BT.709 compliant monitors.
C2:BT.709 Wide DR	BT.709 Wide DR / BT.709	Video	–	These settings produce a wide dynamic range and are appropriate for playback on BT.709 compliant monitors.
C3:BT.709 Standard	BT.709 Standard / BT.709	Video	–	These settings are appropriate for playback on BT.709 compliant monitors, and use a gamma curve that meets ITU-R BT.709 standards.
C4:Canon Log 3	Canon Log 3 / C.Gamut	Neutral	–	These settings use Canon Log 3 gamma and require postproduction processing.
C5:PQ	PQ / BT.2020	Neutral	–	These settings use a high dynamic range gamma curve compliant with the PQ standard defined by ITU-R BT.2100.*
C6:HLG	HLG / BT.2020	Neutral	–	These settings use a high dynamic range gamma curve compliant with the HLG standard defined by ITU-R BT.2100.*
C7:EOS Standard	BT.709 Wide DR / BT.709	Neutral	On	Reproduces the image quality and look of an EOS interchangeable lens DSLR camera with its picture style set to [Standard].
C8:EOS Neutral	BT.709 Wide DR / BT.709	Neutral	On	Reproduces the image quality and look of an EOS interchangeable lens DSLR camera with its picture style set to [Neutral].
C9:Canon 709	Canon 709 / BT.709	Neutral	–	These settings produce a look appropriate also for use without post processing, featuring high contrast while ensuring a wide dynamic range optimized for playback on BT.709 compliant monitors.
C10:User10 to C20:User20	BT.709 Normal / BT.709	Video	–	These settings produce a wide dynamic range and are appropriate for playback on BT.709 compliant monitors.

* ITU-R BT.2100 is a standard for a color bit depth of 10 or 12 bits. When the output video is set to one of the 8 bit color options, the gamma curve is approximately equivalent to this standard.

Note

- About the logarithmic gamma curves (Canon Log 3 settings)
 - These gamma curves require post-production processing. They were designed to make the most of the imaging sensor characteristics in order to obtain impressive levels of dynamic range.
 - While shooting, you can apply a LUT to the 12G-SDI OUT terminal's image or the view assistance function to the HDMI OUT / 3G-SDI OUT terminal's image to use gamma curve settings more suitable for monitoring (P. 51).
 - There are also other LUTs available that can be applied for processing in post-production.
 - * For the latest information on available LUTs, please visit your local Canon website.

[Lock]

Protecting a custom picture file prevents its settings from being accidentally changed. Click [Lock] to protect/unprotect the custom picture file.

[Reset]

Resets the settings of the selected custom picture file (P. 43).

[CP File Name]

Rename the selected custom picture file.

Note

The characters that can be used in a file name are as follows.

Characters: Single-byte alphanumeric characters

Symbols: ! " # \$ % & ' () * + , - . / : ; < = > ? @ [\] ^ _ { | } ~

[Gamma/Color Space]

Combination of gamma curve and color space settings that affects the overall look and color space of the image.

[Canon Log 3 / C.Gamut], [Canon Log 3 / BT.2020], [Canon Log 3 / BT.709], [PQ / BT.2020], [HLG / BT.2020], [BT.709 Wide DR / BT.2020], [BT.709 Wide DR / BT.709], [BT.709 Normal / BT.2020], [BT.709 Normal / BT.709], [BT.709 Standard / BT.709], [Canon 709 / BT.709]

Gamma

[Canon Log 3]:

Logarithmic gamma curve that keeps the characteristics of the [Canon Log] setting while expanding its dynamic range. Requires image processing in post-production.

[PQ]: HDR (high dynamic range) gamma curve compliant with the PQ standard defined by ITU-R BT.2100.*

[HLG]: HDR (high dynamic range) gamma curve compliant with the HLG standard defined by ITU-R BT.2100.*

[BT.709 Wide DR]:

Gamma curve with a very wide dynamic range. Optimized for playback on BT.709 compliant monitors. Equivalent to the [Wide DR] setting in previous camera models.

[BT.709 Normal]:

Gamma curve that produces darker dark areas and reduced contrast in the highlights, compared to the ITU-R BT.709 standard. Optimized for playback on BT.709 compliant monitors. Equivalent to the [Normal 1] setting in previous camera models.

[BT.709 Standard]:

Gamma curve that meets ITU-R BT.709 standards, for playback on BT.709 compliant monitors. Equivalent to the [Normal 3] setting in previous camera models.

[Canon 709]:

Gamma curve appropriate also for use without post processing, featuring high contrast while ensuring a wide dynamic range. Use this when outputting to a BT.709 compliant monitor.

* ITU-R BT.2100 is a standard for a color bit depth of 10 or 12 bits. When the output video is set to one of the 8 bit color options, the gamma curve is approximately equivalent to this standard.

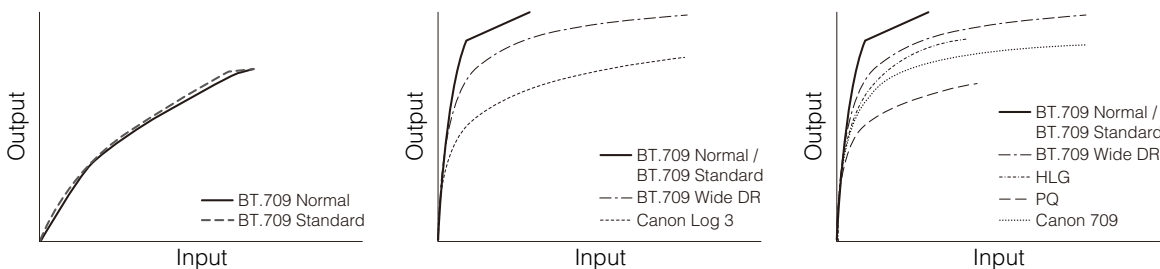

Color space

[C.Gamut]:

Color space developed by Canon based on the specific characteristics of the camera's imaging sensor. It covers a wider color gamut than that of BT.2020.

[BT.2020]:

Color space that meets ITU-R BT.2020 standards, which defines parameters for ultrahigh-definition television (4K/8K).

[BT.709]: Standard color space that is compatible with ITU-R BT.709 specifications.

[Color Matrix]

Select the video's image tone.

[Neutral]

Reproduces neutral colors.

[Production Camera]

Reproduces colors more suitable for motion picture production.

[Video]

Reproduces colors with a contrast suitable for TV broadcasting.

[HLG Color]

Changes the quality of color reproduction when using the hybrid log gamma (HLG). This setting is only available when [Gamma/Color Space] is set to [HLG / BT.2020].

[BT.2100]

Color reproduction according to ITU-R BT.2100 specifications.

[Vivid]

More saturated color reproduction according to the 'Traditional Colour' approach in ITU-R BT.2390.

[Edit]

Detailed custom picture settings related to image quality. Click  on the upper right corner of the settings area to finish editing.

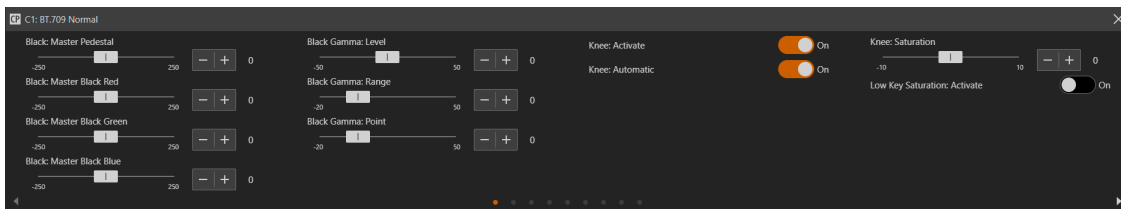

[Black: Master Pedestal]

Adjusts the black level.

Higher settings will make dark areas brighter but decrease contrast. This setting is not available when the gamma curve component of the [Gamma/Color Space] setting is set to [Canon Log 3].

[Black: Master Black Red], [Black: Master Black Green], [Black: Master Black Blue]

These settings correct the color cast in blacks.

These settings are not available when the gamma curve component of the [Gamma/Color Space] setting is set to [Canon Log 3].

[Black Gamma: Level], [Black Gamma: Range], [Black Gamma: Point]

These settings control the lower part of the gamma curve (dark areas of the image). By changing each value, the gamma curve on the black side within the range shown in the figure below is adjusted.

These settings are only available when the gamma curve component of the [Gamma/Color Space] setting is set to one of the [BT.709 Normal] or [BT.709 Standard] options.

- [Level]: Raises or lowers the lower part of the gamma curve.
- [Range]: Selects the adjustment range from the selected [Point].
- [Point]: Determines the shape of the lower part of the gamma curve.

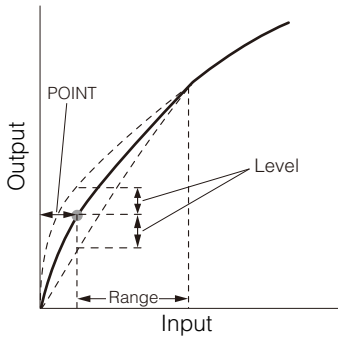

[Knee: Activate], [Knee: Automatic], [Knee: Slope], [Knee: Point], [Knee: Saturation]

Compresses the highlighted areas to suppress the occurrence of blown highlights. These settings are only available when the gamma curve component of the [Gamma/Color Space] setting is set to one of the [BT.709 Normal] or [BT.709 Standard] options.

- [Activate]: Enables knee adjustment.
- [Automatic]: Enables automatic knee adjustment.
- [Slope]: Indicates the slope of the knee.
- [Point]: Indicates the knee point.
- [Saturation]: Adjusts the color intensity in the highlighted areas.

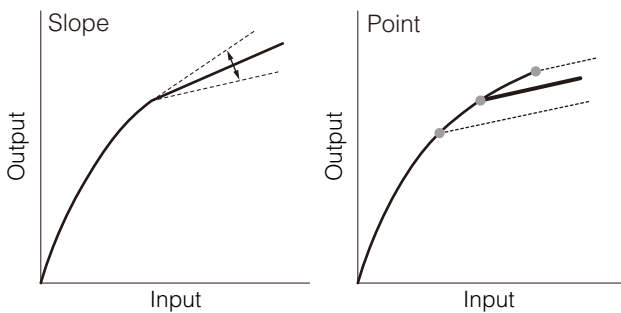

[Low Key Saturation: Activate], [Low Key Saturation: Level]

Specifies how saturated colors are in dark areas.

- [Activate]: Set this setting to [On] to enable the adjustment of color saturation in dark areas with the [Level] setting.
- [Level]: Specifies how saturated colors are in dark areas.

[Sharpness: Level]

Adjust the level of edge enhancement.

[Sharpness: Detail Frequency]

Sets the center frequency of horizontal sharpness. Setting higher values increases the frequency, which, in turn, increases the sharpness.

[Sharpness: Coring Level]

Sets the level of correction of artifacts caused by high sharpness levels (coring). Higher values prevent sharpness from being applied to minute details, resulting in less noise.

[Sharpness: Limit]

Adjusts the level at which the edge enhancement is limited.

[Noise Reduction: Automatic]

When set to [Auto], the noise reduction level is automatically adjusted.

[Noise Reduction: Spatial Filter]

Reduces noise by applying a soft focus-like effect on the entire picture. When set to a value other than [0], afterimages are not produced but the whole image will have a softer look.

[Noise Reduction: Frame Correlation]

Reduces noise elements by comparing the current image to the previous one (field). When set to a value other than [0], the perceived resolution will not be affected but an afterimage may appear for moving subjects.

[Skin Detail: Effect Level], [Skin Detail: Assist], [Skin Detail: Hue], [Skin Detail: Chroma], [Skin Detail: Area], [Skin Detail: Y Level]

The camera applies a softening filter to areas in the picture with skin tones to give a more pleasant appearance.

- [Effect Level]: Adjusts the level of the filter. Three adjustment levels are available, with [High] being the maximum setting.
- [Assist]: When set to [On], a zebra pattern will appear on the screen or video output terminal over areas of the image that are detected as having skin tones.
- [Hue]: Adjusts the hue for detection of skin tones.
- [Chroma]: Adjusts the color saturation for detection of skin tones.
- [Area]: Adjusts the color range for detection of skin tones.
- [Y Level]: Adjusts the brightness for detection of skin tones.

[White Balance: R Gain], [White Balance: G Gain], [White Balance: B Gain]

These settings adjust the amount of white balance throughout the whole image by changing the intensity of red tones ([R Gain]), green tones ([G Gain]) and blue tones ([B Gain]).

[Over 100%]

Determines how the camera handles video signals exceeding 100%. This setting is not available when the gamma curve component of the [Gamma/Color Space] setting is set to one of the [Canon Log 3], [PQ], [HLG] or [Canon 709] options.

- [Through]: Leave the signal unchanged.
- [Clip]: Clip the signal at 100%.
- [Press]: Compress a signal of up to 108% down to 100% levels.

[Color Matrix Tuning: Gain], [Color Matrix Tuning: Phase], [Color Matrix Tuning: R-G], [Color Matrix Tuning: R-B], [Color Matrix Tuning: G-R], [Color Matrix Tuning: G-B], [Color Matrix Tuning: B-R], [Color Matrix Tuning: B-G]

Adjusts the tint of the picture.

- [Gain]: Adjusts the color intensity.
- [Phase]: Adjusts the color phase of the color matrix.
- [R-G]: cyan/green and red/magenta
- [R-B]: cyan/blue and red/yellow
- [G-R]: magenta/red and green/cyan
- [G-B]: magenta/blue and green/yellow
- [B-R]: yellow/red and blue/cyan s
- [B-G]: yellow/green and blue/magenta

[Color Correction: Select Area]

The camera detects areas with certain color characteristics and corrects them. You can set the color correction for up to two different areas (A and B) and apply the color correction to either one or both of them.

[Color Correction: Assist]

While color correction is activated, parts of the image that are not detected as having the characteristics specified for area A or B will appear colorless on the image output from the output terminals and the IP streaming video (except when adjusting the [Revision Level]/[Revision Phase] settings).

[Area A: Setting Phase], [Area A: Setting Chroma], [Area A: Setting Area], [Area A: Setting Y Level], [Area A: Revision Level], [Area A: Revision Phase]

[Area B: Setting Phase], [Area B: Setting Chroma], [Area B: Setting Area], [Area B: Setting Y Level], [Area B: Revision Level], [Area B: Revision Phase]

- [Area A: Setting Phase], [Area B: Setting Phase]: These settings determine the color phase of the area to be corrected (A or B, respectively).
- [Area A: Setting Chroma], [Area B: Setting Chroma]: These settings determine the color saturation of the area to be corrected (A or B, respectively).
- [Area A: Setting Area], [Area B: Setting Area]: These settings determine the color range of the area to be corrected (A or B, respectively).
- [Area A: Setting Y Level], [Area B: Setting Y Level]: These settings determine the brightness of the area to be corrected (A or B, respectively).
- [Area A: Revision Level], [Area B: Revision Level]: These settings adjust the amount of correction applied to the color saturation in the corrected area (A or B, respectively).
- [Area A: Revision Phase], [Area B: Revision Phase]: These settings adjust the amount of correction applied to the color phase in the corrected area (A or B, respectively).

 **Note**

- The following settings are not available when infrared shooting is activated.
 - Color Matrix
 - HLG Color
 - Low Key Saturation
 - Skin Detail

- Color Matrix Tuning
 - White Balance
 - Color Correction
- Depending on other menu settings, you may not be able to obtain the desired image effect even after changing the custom picture settings.

[Look File]

You can register LUT files created with Blackmagic Design's DaVinci Resolve as Look Files in the custom picture file. Using a Look File allows you to adjust the video quality of the video. These adjustments apply also to output terminals. When set to [On], the image quality adjustments set in the Look File will be applied.

■ Resetting Custom Picture Files

1 Click [Reset].

The settings screen is displayed.

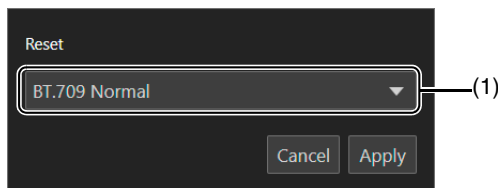

(1) Preset

Select the desired preset custom picture settings.

2 Select any of the preset settings and click [Apply].

The settings of the selected custom picture file are reset.

■ Registering a Look File

1 Click [Register].

The settings screen is displayed.

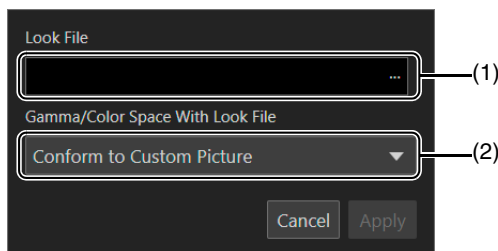

(1) [Look File]

Displays the selected Look File.

(2) [Gamma/Color Space With Look File]

Select the [Gamma/Color Space] setting to use after the Look File is applied.

2 Click [...] and specify the Look File to register.

3 Select [Gamma/Color Space With Look File] and click [Apply].

The selected Look File will be loaded and registered in the custom picture file. The image quality adjustments set in the Look File will be applied.

■ Deleting Look Files

1 Select the custom picture file with the registered Look File to delete.

2 Click [Delete].

A confirmation message is displayed.

3 Click [Apply].

The Look File registered in the custom picture file will be deleted.

Note

- About Look Files
 - The camera supports LUT Files (3D LUT / .cube format) in 17 grid or 33 grid format created with Blackmagic Design's DaVinci Resolve.
 - LUT files with input ranges outside the 0 to 1 range in the header ("LUT_3D_INPUT_RANGE") are not supported.
 - LUT files which include values outside of the 0 to 1 range in the data area are not supported.
 - LUT files 2 MB and larger, as well as files with a name containing over 65 characters are not supported.
 - The characters that can be used in a file name are as follows.
Characters: Single-byte alphanumeric characters
Symbols: ! " # \$ % & ' () * + , - . / : ; < = > ? @ [\] ^ _ { | } ~
- If the correct input/output gamma curve and color space conversion are not selected, video will not be output correctly.
- A Look File cannot be used if the [Gamma/Color Space], [HLG Color] or [Over 100%] settings are changed after registering it.
- When the gamma curve component of the [Gamma/Color Space] setting in the custom picture is set to either [BT.709 Normal], [BT.709 Standard] or [BT.709 Wide DR], super-white (video signal above 100%) and superblack (video signal below 0%) levels of brightness will be clipped. When the video signal contains super-white brightness levels, select [Edit] > [Over 100%] > [Press] and then activate the Look File to apply it to a signal compressed to 100%.
- It may take some time to load Look Files.

PTZ/IS Settings

Settings for the camera's pan, tilt, and zoom operations and image stabilizer.

To display the [PTZ/IS] tab, select the [Camera Control 1] menu to the left of the settings area.

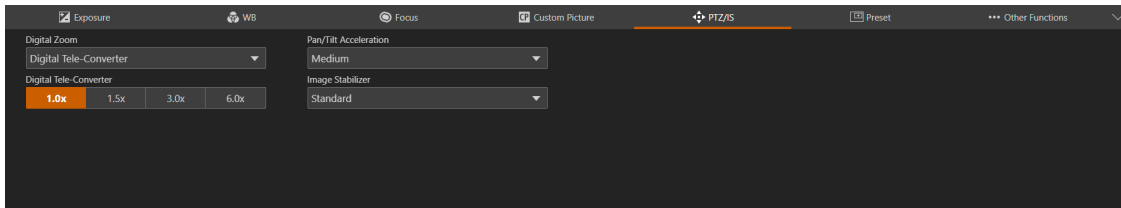

[Digital Zoom]

Select whether to use digital zoom ([300x]), the digital tele-converter function or advanced zoom ([Advanced 30x]: the camera can zoom up to 30x combining the optical zoom and additional processing).

Note

- The advanced zoom setting can only be used when [System] > [Environment] > [Maximum Resolution] is set to [1920x1080] (P. 99).

[Digital Tele-Converter]

When [Digital Zoom] is set to [Digital Tele-Converter], select the magnification of the focal length. Because the image is processed digitally, the video is coarser over the entire zoom range.

[Pan/Tilt Acceleration]

Select the degree of acceleration of the pan/tilt operation.

[Image Stabilizer]

Select whether to use a function that reduces the blurring of videos caused by camera vibration.

[Standard] corrects relatively small blurs.

[Powered IS] corrects blurring during telephoto shooting. The closer the zoom is to the telephoto side, the greater the correction effect.

Note

- If the blurring is too large, it may not be corrected completely.
- For pan and tilt, the anti-vibration effect is smaller than compared to when not operating.
- Swing back may occur when the pan/tilt stops.

Preset Settings

By registering preset camera settings such as camera angle, exposure, and image quality, it is possible to easily call the presets and execute the settings.

To display the [Preset] tab, select the [Camera Control 1] menu to the left of the settings area.

Registering Presets

- 1 Click the [Preset] tab on the settings page
Displays the preset settings.
- 2 Click the preset number field to register, and click [Add] to register.

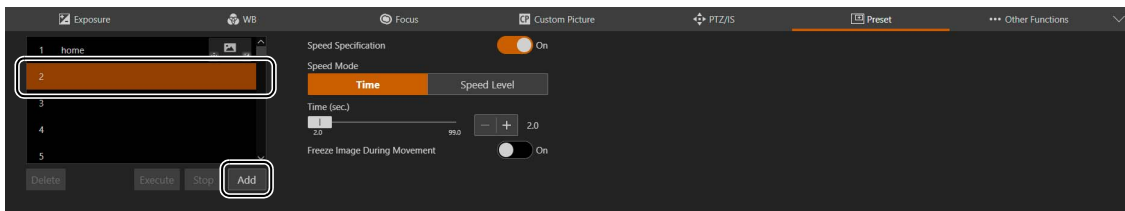

The settings screen will pop up.

- 3 Set the preset items and click [Add]

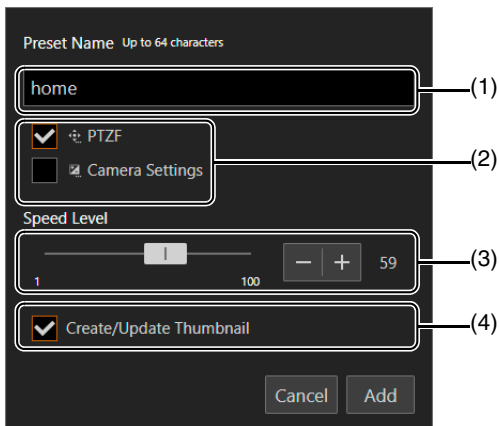

- (1) [Preset Name]
Enter a preset name.
- (2) [PTZF], [Camera Settings]
Check the items to preset.

Item	Preset target
PTZF	Pan/Tilt/Zoom position [Focus] [PTZ/IS] > [Digital Zoom], [Pan/Tilt Acceleration]
Camera Settings	[Exposure]* [WB] [CP] > [CP File] [PTZ/IS] > [Image Stabilizer]

* Excluding [Gain Boost].

- (3) [Speed Level]
Sets the pan/tilt speed and zoom speed for a registered preset.
- (4) [Create/Update Thumbnail]

Displays the image at the time of registration in the preset list as a thumbnail. Uncheck this check box if you do not need to display thumbnails, or if you do not wish to update thumbnails when a preset is edited.

The preset is saved to the camera and displayed in the list as follows:

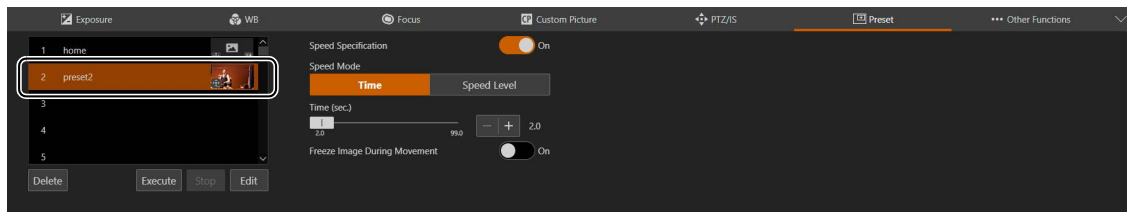

The  icon at the bottom of the thumbnail means that the presets include a PTZF setting.

 means that the presets include a camera quality setting.

For presets with unregistered thumbnails, the following icon is displayed.

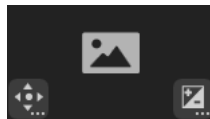

4 Repeat steps 2 to 3 to register multiple presets.

Note

- [home] is the setting when the camera was launched (home position). It can be overwritten but cannot be deleted.
- Able to register up to 100 presets (including home position) in the camera.
- If the thumbnail is not updated when a preset is edited, the displayed thumbnail may differ from the actual preset state.

Calling Presets and Speed Specification

Select the preset to call from the list and click [Execute] to reflect the preset settings on the camera.

Confirm in the video display area. You can also set the display method shown during preset movement.

The speed at which the camera moves to the pan/tilt/zoom position can be specified as the one set when registering the preset or a different one.

1 Select the preset to call from the list and set [Speed Specification] to either off or [On].

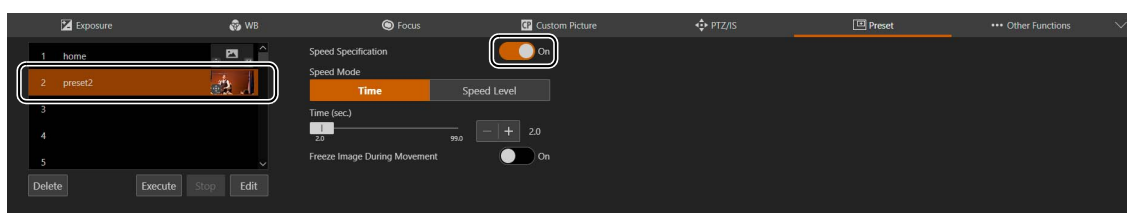

Set [Speed Specification] to off to use the speed level set when registering the preset.

If set to off, continue from step 3.

If set to [On], continue from step 2.

2 Select [Speed Mode] > [Time] or [Speed Level] and adjust the value using the slider.

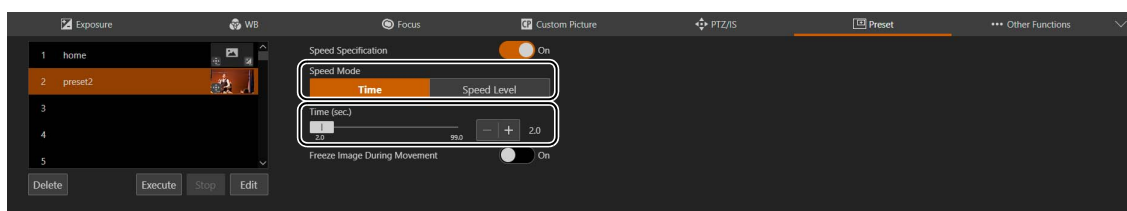

If you specify a speed that differs from the one set when registering the preset, select [Time] or [Speed Level].

3 Set [Freeze Image During Movement]

If set to [On], you can display a still image of the video (set at the time movement starts) during preset movement. You can also change the default value (P. 92).

4 Click [Execute].

The camera moves to the pan/tilt/zoom position at the speed specified in step 1 or 2.

Note

- If the pan/tilt/zoom or focus of the camera is operated while a preset is running, the preset stops. However, another preset can be called while a preset is running.
- If [Stop] is clicked while a preset is running on a camera, the preset stops.
- Depending on the relationship between the pan/tilt/zoom position before the call and the registered pan/tilt/zoom position, and the [Time] setting, it may not operate within the set time.
- Camera settings other than the pan/tilt/zoom position settings are reflected immediately when [Execute] is clicked.
- If you perform one of the following operations when a still image is being displayed, the displayed image returns to the normal video display.
 - Changing the HDMI/SDI signal output format (video size/frame rate, mapping) settings.
 - Turning color bars on.
- If you input a sync signal to the GEN-LOCK terminal and execute a preset before synchronization is stabilized, still images will not be displayed. If a sync signal is input to the GEN-LOCK terminal while a still image is displayed, synchronization will start when the still image display ends.

Deleting Presets

Select the preset to delete from the list and click [Delete] to delete it from the camera.

Other Functions

Configure the color bar output and Add-On settings.

To display the [Other Functions] tab, select the [Camera Control 1] menu to the left of the settings area.

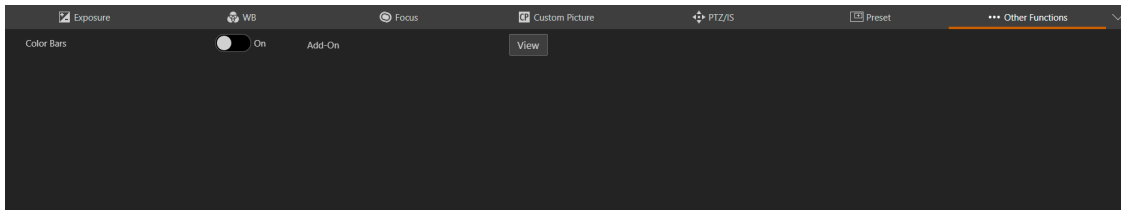

[Color Bars]

Outputs color bars, useful when adjusting the color and brightness settings of an external monitor.

To set the color bar type, select [System] > [System] > [Camera] > [Color Bar Type].

Note

- When color bars are being output, functions that cannot be set appear in gray.
- Color bars cannot be output when the gamma curve component of the [Gamma/Color Space] setting in the custom picture file is set to an option other than [BT.709 Wide DR], [BT.709 Normal], [BT.709 Standard] or [Canon 709].

[Add-On] (P. 95)

Click [View] to display a list of the running applications.

When you click [Open] for the application you want to use, [Add-On Top Page] is displayed, where you can configure the application settings.

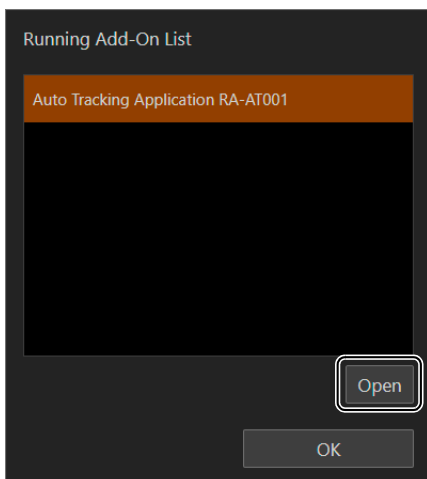

Crop Settings

Settings related to screen cropping. It is possible to crop an area of the screen and output it from the 12G-SDI OUT terminal or HDMI OUT/3G-SDI OUT terminal. Up to two cropping areas can be set. The resolution of the output image is set using the [System] > [Video and Audio] > [HDMI/SDI] > [HDMI/SDI Shared] and [Crop] settings (P. 65). To display the [Crop] tab, select the [Camera Control 2] menu to the left of the settings area.

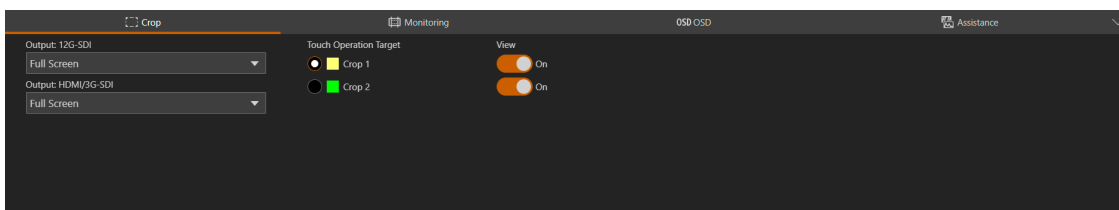
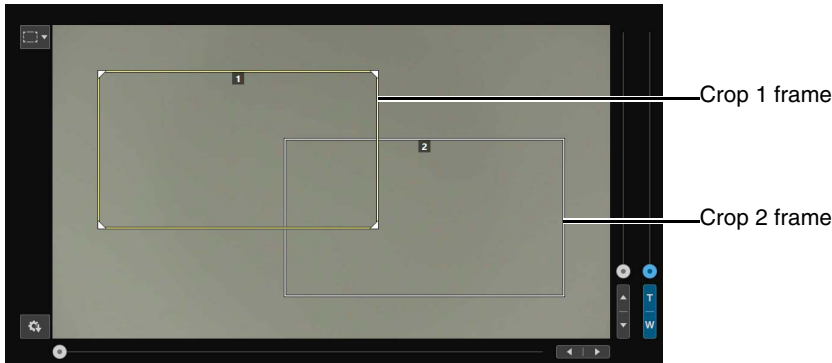

Note

- The crop function can only be used when [System] > [Environment] > [Maximum Resolution] is set to [3840x2160] (P. 99).
- The image output from the HDMI OUT terminal and the 3G-SDI OUT terminal will be the same.
- Cropping settings are also reflected when the camera is turned on.

[Output: 12G-SDI], [Output: HDMI/3G-SDI]

Select the area to output from the 12G-SDI OUT terminal or HDMI OUT/3G-SDI OUT terminal. When set to [Full Screen], the image will be output without cropping.



[Touch Operation Target]



Selects the screen area to operate. The cropping frame can only be moved within the selected area. Additionally, only the area size of the cropping frame for [Crop 1] can be changed.

[View]

When set to [On], the cropping frame is displayed on the screen. Even if the cropping frame is not displayed, the cropped image will be output from the 12G-SDI OUT terminal or HDMI OUT/3G-SDI OUT terminal.

About the cropping frame

When the clip operation menu (P. 21) is  [Crop], click the screen to move the cropping frame to that position (the clicked position being the center of the frame). You can also move the cropping frame by dragging it to the desired position when the mouse pointer inside the cropping frame is .

To change the area size of the cropping frame, drag a corner () or the sides of the frame (when the mouse pointer is ) to adjust it to the desired size.

Note

- The cropping frame cannot be moved outside of the screen.
- The aspect ratio of the cropping frame is fixed to 16:9.

Monitoring Settings

Configure HDMI/SDI output video signal settings.

To display the [Monitoring] tab, select the [Camera Control 2] menu to the left of the settings area.

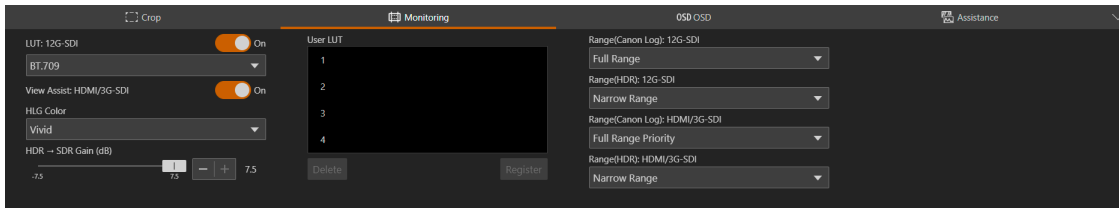

[LUT: 12G-SDI], [View Assist: HDMI/3G-SDI]

While shooting using special gamma curves, you can apply a LUT to the image output from the 12G-SDI OUT terminal to change the gamma/color space to a standard one. Additionally, by activating the view assistance function you can change the gamma/color space of the image output from the HDMI OUT terminal / 3G-SDI OUT terminal to be equivalent to BT.709 Wide DR/BT.709. When set to [On], the LUT/View Assistance function is applied. Whether or not the available LUT/View Assistance function can be applied depends on the [Gamma/Color Space] and [Look File] settings (changing these settings turns off the LUT/View Assistance function) in the custom picture file (P. 38).

LUT

List of LUTs

Applied LUT	Gamma	Color space	Description
[BT.709]	BT.709 Wide DR	BT.709	LUT for viewing on external monitors compatible with BT.709 specifications.
[BT.2020]	BT.709 Wide DR	BT.2020	LUT for viewing on external monitors compatible with ITU-R BT.2020 standards, which define parameters for ultra-high-definition television (4K/8K).
[DCI]	DCI	DCI-P3	LUT for viewing on external monitors that support color spaces and gamma curves that follow the guidelines established by DCI (Digital Cinema Initiatives).
[PQ]	PQ	BT.2020	LUT for viewing HDR (high dynamic range) images on external monitors compatible with the PQ standard defined by ITU-R BT.2100. The signal output will use narrow range (video range) coding.
[HLG]	Hybrid Log-Gamma	BT.2020	LUT for viewing HDR (high dynamic range) images on external monitors compatible with the HLG standard defined by ITU-R BT.2100. The signal output will use narrow range (video range) coding.
[CMT 709]	CMT 709	BT.709	LUT for viewing on external monitors compatible with BT.709 specifications. It produces a look suitable for a cinema production, keeping a wide dynamic range without clipping when log recording.
[User LUT1] to [User LUT4]	Registered gamma curve	BT.709, BT.2020, Unchanged	LUT used to check the registered gamma curve, as well as the color space and range settings on a screen.

Available LUTs

Custom picture file		Available LUTs						
Look Files	[Gamma/Color Space] after the Look File is applied	[BT.709]	[BT.2020]	[DCI]	[PQ]	[HLG]	[CMT 709]	[User LUT1] to [User LUT4]
Off	–	See the following table (A)						
[On]	[Conform to Custom Picture]							
	[SDR BT.709]	–	–	–	–	–	–	–
	[SDR BT.2020]	●	–	–	–	–	–	–
	[HDR PQ (BT.2100)]	●	–	–	–	–	–	–
	[HDR HLG (BT.2100)]	●	–	–	–	–	–	–

Available LUTs (A)

Custom picture file		Available LUTs						
[Gamma/Color Space]		[BT.709]	[BT.2020]	[DCI]	[PQ]	[HLG]	[CMT 709]	[User LUT1] to [User LUT4]
[Canon Log 3 / C.Gamut]		●	●	●	●	●	●	●
[Canon Log 3 / BT.2020]		●	●	–	●	●	–	●
[Canon Log 3 / BT.709]		●	–	–	–	–	–	●
[PQ / BT.2020]		●	–	–	–	–	–	–
[HLG / BT.2020]		●	–	–	–	–	–	–
[BT.709 Wide DR / BT.2020]		●	–	–	–	–	–	–
[BT.709 Wide DR / BT.709]								
[BT.709 Normal / BT.2020]								
[BT.709 Normal / BT.709]		–	–	–	–	–	–	–
[BT.709 Standard / BT.709]								
[Canon 709 / BT.709]								

■ View Assistances

List of View Assistances

Applied View Assistance	Gamma	Color space	Description
[BT.709]	Equivalent to BT.709 Wide DR	Equivalent to BT.709	Changes the image for viewing on external monitors compatible with BT.709 specifications.
[CMT 709]	Equivalent to CMT 709	Equivalent to BT.709	Changes the image for viewing on external monitors compatible with BT.709 specifications. It produces a look suitable for a cinema production, keeping a wide dynamic range without clipping when log recording.

Available View Assistances

Custom picture file		Available View Assistances	
Look Files	[Gamma/Color Space] after the Look File is applied	[BT.709]	[CMT 709]
Off	–	See the following table (B)	
[On]	[Conform to Custom Picture]		
	[SDR BT.709]	–	–
	[SDR BT.2020]	●	–
	[HDR PQ (BT.2100)]	●	–
	[HDR HLG (BT.2100)]	●	–

Available View Assistances (B)

Custom picture file	Available View Assistances	
[Gamma/Color Space]	[BT.709]	[CMT 709]
[Canon Log 3 / C.Gamut]	●	●
[Canon Log 3 / BT.2020]	●	–
[Canon Log 3 / BT.709]	●	–
[PQ / BT.2020]	●	–
[HLG / BT.2020]	●	–
[BT.709 Wide DR / BT.2020]	●	–
[BT.709 Wide DR / BT.709]	–	–
[BT.709 Normal / BT.2020]		
[BT.709 Normal / BT.709]		
[BT.709 Standard / BT.709]		
[Canon 709 / BT.709]		

Note

- If the view assistance function is applied, the signal output will use narrow range (video range) coding.
- The colors modified by using this function are an approximation, and differ from the colors obtained when you set [Gamma/Color Space] in the custom picture file (P. 38) to [BT.709 Wide DR / BT.709].
- If the view assistance function is applied, the colors in the dark areas / highlights of the image may not be displayed accurately.

[HLG Color]

You can change the quality of the color reproduction when the [HLG] LUT is applied.

[BT.2100]

Color reproduction according to ITU-R BT.2100 specifications.

[Vivid]

More saturated color reproduction according to the 'Traditional Colour' approach in ITU-R BT.2390.

[HDR → SDR Gain (dB)]

When using HDR*, you can adjust the SDR gain difference relative to HDR when a LUT or view assistance function that changes the color space to BT.709 is applied to the output.

* When the [Gamma/Color Space] setting in the custom picture file is set to [PQ / BT.2020] or [HLG / BT.2020], or when the [Gamma/Color space] setting after applying a Look File is set to [HDR PQ (BT.2100)] or [HDR HLG (BT.2100)].

[User LUT]

You can register in the camera up to four Look Files and apply them to video output from the 12G-SDI OUT terminal (when using log gamma). You can adjust the output color space and range of user LUTs.

■ Registering a User LUT

- 1 Click the number field of the user LUT to be registered, then click [Register].

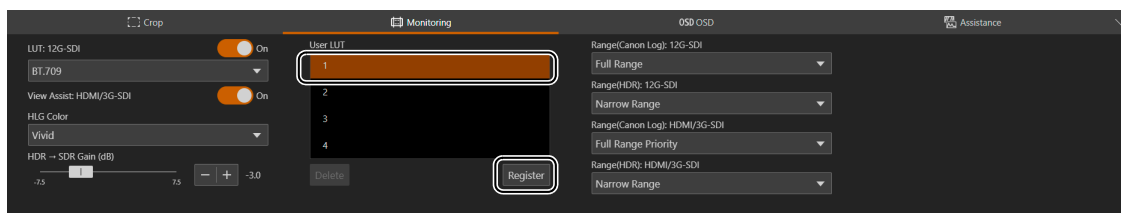

The settings screen is displayed.

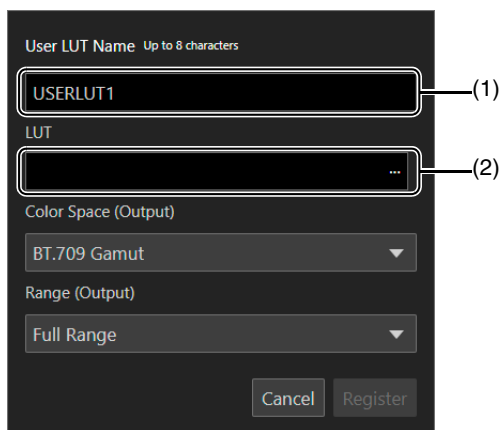

- (1) [User LUT Name]
Enter a user LUT name.
- (2) [LUT]
Select a LUT file.

Note

The characters that can be used in a file name are as follows.
Characters: Single-byte alphanumeric characters
Symbols: ! " # \$ % & ' () * + , - . / : ; < = > ? @ [\] ^ _ { | } ~

- 2 Click [...] and specify the LUT file to be registered.
- 3 Select the color space for the output signal ([Color Space (Output)]).
To leave the color space unchanged, select [Do Not Convert] instead.
- 4 Select the output range ([Range (Output)]).
- 5 Click [Register].

■ Editing a User LUT

- 1 Click the number field of the user LUT to be edited.
- 2 Click [Edit].
The settings screen is displayed.
- 3 Change the settings as needed.
- 4 Click [Register].

 **Note**

The LUT file specified when registering a user LUT cannot be specified again. Register a new user LUT.

■ Deleting a User LUT

1 Select the number field of the user LUT to be deleted.

2 Click [Delete].

A confirmation message is displayed.

3 Click [Apply].

The selected user LUT will be deleted.

[Range (Canon Log): 12G-SDI], [Range (HDR): 12G-SDI], [Range (Canon Log): HDMI/3G-SDI], [Range (HDR): HDMI/3G-SDI]

You can select the output range of video signals (when using log gamma or PQ/HLG HDR) output from the 12G-SDI OUT terminal or HDMI OUT / 3G-SDI OUT terminal.

Applied output range settings

Custom picture file			Applied range settings
Gamma	Look Files	[Gamma/Color Space] after the Look File is applied	[Range (Canon Log): 12G-SDI], [Range (HDR): 12G-SDI], [Range (Canon Log): HDMI/3G-SDI], [Range (HDR): HDMI/3G-SDI]
[Canon Log 3]	Off	–	[Range (Canon Log): 12G-SDI], [Range (Canon Log): HDMI/3G-SDI]
	[On]	[Conform to Custom Picture]	
[PQ]	Off	–	[Range (HDR): 12G-SDI], [Range (HDR): HDMI/3G-SDI]
	[On]	[Conform to Custom Picture]	
[HLG]	Off	–	
	[On]	[Conform to Custom Picture]	
[BT.709 Wide DR]	Off	–	– (Fixed narrow range)
	[On]	[Conform to Custom Picture]	
[BT.709 Normal]	Off	–	
	[On]	[Conform to Custom Picture]	
[BT.709 Standard]	Off	–	
	[On]	[Conform to Custom Picture]	
[Canon 709]	Off	–	
	[On]	[Conform to Custom Picture]	
–	[On]	[SDR BT.709]	[Range (HDR): 12G-SDI], [Range (HDR): HDMI/3G-SDI]
		[SDR BT.2020]	
		[HDR PQ (BT.2100)]	
		[HDR HLG (BT.2100)]	

12G-SDI OUT Terminal

[Full Range]

The signal output will use full range coding.

[Narrow Range]

The signal output will use narrow range (video range) coding.

HDMI OUT Terminal or 3G-SDI OUT Terminal

[Full Range Priority]

The signal output will use full range coding whenever possible but will change the range automatically according to the capabilities of the connected monitor.

[Narrow Range]

The signal output will use narrow range (video range) coding.



Note

- Settings will change depending on the gamma curve component of the [Gamma/Color Space] setting in the custom picture file and the [Gamma/Color Space] setting after a Look File has been applied. When a LUT is applied, settings will change also depending on the gamma curve selected for the output signal. If a user LUT is applied, the output range will be determined by the user LUT's [Range (Output)] setting.

OSD Settings

Settings for the onscreen displays superimposed on the HDMI/SDI output video signal.

To display the [OSD] tab, select the [Camera Control 2] menu to the left of the settings area.

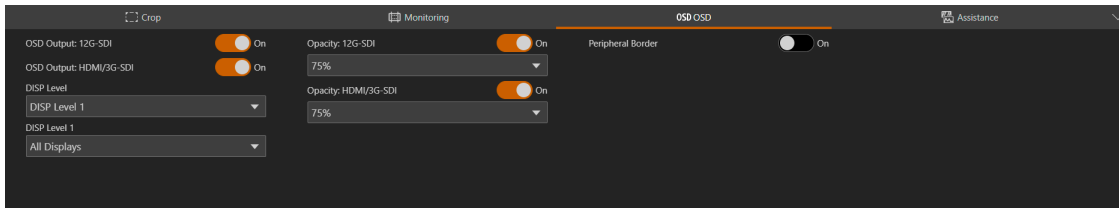

[OSD Output: 12G-SDI], [OSD Output: HDMI/3G-SDI]

When set to [On], onscreen displays are superimposed on the HDMI/SDI output video signal.

Note

When the area to output set in [Crop] settings (P. 50) is set to an option other than [Full Screen], onscreen displays cannot be superimposed.

[DISP Level]

Selects the amount of information shown over the image.

[DISP Level 1]

All onscreen displays. You can choose between [All Displays] or [All Displays (Periph. Border)]. When set to [All Displays (Periph. Border)], all onscreen displays are displayed at a smaller size.



All Displays

[DISP Level 2]

Only the onscreen displays most relevant for shooting. You can select between [Shooting Information Display] and [Markers and Focus Frame Only].

[Opacity: 12G-SDI], [Opacity: HDMI/3G-SDI]

You can make onscreen displays more visible or less conspicuous by changing their opacity level. A lower percentage value indicates lower opacity.

[Peripheral Border]

A peripheral border (frame) is applied and the camera's image is reduced slightly so the onscreen displays are shown mostly around it and not on top of it, partially hiding it.



All Displays (Periph. Border)

Note

When displaying the onscreen displays on the peripheral border, set the resolution in the video output configuration (P. 65) to an option other than 720x480 or 720x576.

About onscreen displays

There are two DISP levels to choose from when adjusting the amount/position of the information shown over the image (P. 57).

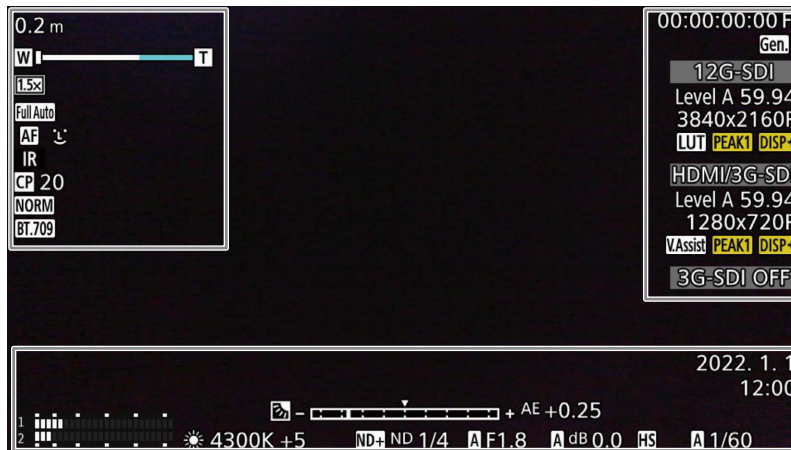









Left side of the screen

Icon/Display	Description
000.0 m	Object distance.
	Zoom (P. 23) The zoom position is an approximation and may differ from the zoom slider's position in the Settings Page (P. 23).
	Digital Tele-Converter (P. 45)
Full Auto	Full Auto Mode (P. 25)
MF AF	Focus Mode (P. 33, P. 37)
	Face AF (P. 34)
IR	Infrared Shooting Mode (P. 26)
CP 00	Custom picture file selected (P. 38)
C.LOG3 / PQ / HLG / Wide DR / NORM / Std. C.Gamut / BT.2020 / BT.709	[Gamma/Color Space] setting in the custom picture file (P. 39).
LOOK	Look Files (P. 43)

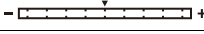
Right side of the screen

Icon/Display	Description
00:00:00.00, 00:00:00:00 F / E	Time Code (P. 93) Time code status (P. 94)
Gen.	Genlock (P. 93)
12G-SDI HDMI/3G-SDI 3G-SDI OFF	Output Terminal Terminal output status (P. 65)
Level A, Level B	Mapping level (P. 66)
00.00	Framerate (fps) (P. 65)
0000x0000P, 0000x0000i	Output signal (P. 65)
LUT V.Assist	A viewing LUT/view assistance has been applied (P. 51)
PEAK1 PEAK2 (in yellow)	Peaking (P. 60)
DISP (in yellow)	Output onscreen displays

Bottom of the screen

Icon/Display	Description
	Audio level meter (P. 70)
 00000 K ±0	White Balance (P. 31)
	Light Metering (P. 29)
	Exposure bar
AE ±0.00	AE Shift (P. 28)
ND 1/00,  ,  , ND - - (in red)	ND filter/ND warning (P. 26)
 F00.0 / closed	Aperture value (P. 26)
 ISO 000000 00.0dB	ISO Speed/Gain (P. 28)
	High Sensitivity Mode (P. 28)
 1/0000.00, 000.00°, 000.00Hz	Shutter Mode (P. 27)
yyyy.mm.dd HH:MM	Date/time.

Note

- Onscreen displays are not superimposed on the IP streaming video.

Assistance Settings

Configure peaking and marker settings.

To display the [Assistance] tab, select the [Camera Control 2] menu to the left of the settings area.

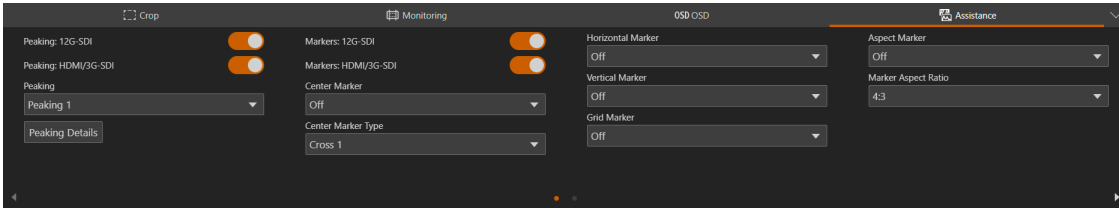

[Peaking: 12G-SDI], [Peaking: HDMI/3G-SDI]

When set to [On], the peaking function is enabled on the HDMI/SDI output video signal.

Note

Peaking cannot be used when the [Color Correction: Assist] setting in the custom picture settings (P. 38) is set to an option other than [Off].

[Peaking]

Select a detailed peaking setting.

[Peaking Details]

Detailed settings related to peaking. Click to display the settings screen.

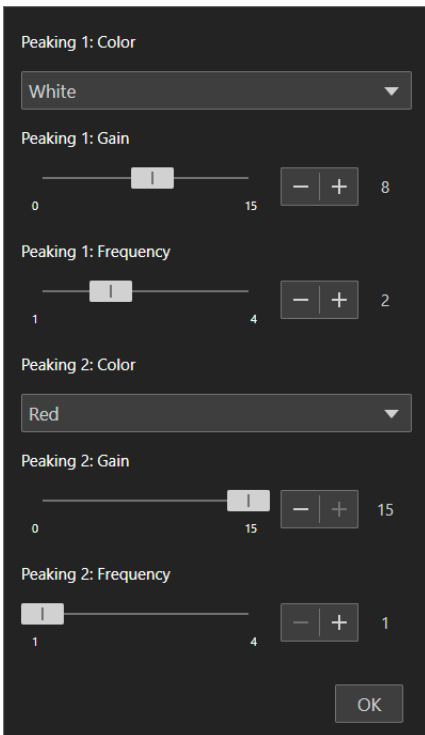

[Peaking 1: Color], [Peaking 2: Color]

Set the color of the two peaking levels independently of each other.

[Peaking 1: Gain], [Peaking 2: Gain], [Peaking 1: Frequency], [Peaking 2: Frequency]

Set the gain and frequency of the two peaking levels independently of each other.

[Markers: 12G-SDI], [Markers: HDMI/3G-SDI]

When set to [On], onscreen markers will be displayed on the HDMI/SDI output video signal.

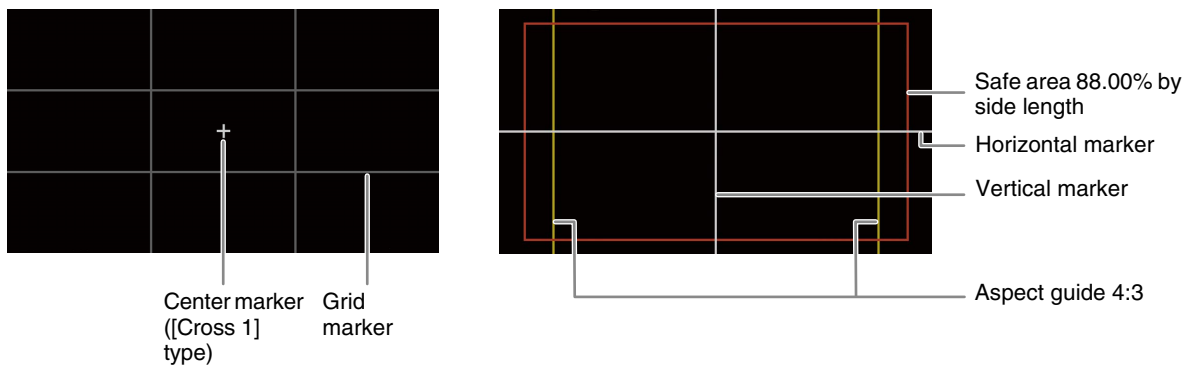

Note

Markers cannot be used when OSD output in the OSD settings (P. 57) is set to off.

[Center Marker]

Displays a marker that indicates the center of the screen. You can select between two types of cross markers, and two types of dot markers.

[Center Marker Type]

Selects the shape of the center marker.

[Horizontal Marker], [Vertical Marker]

Displays a horizontal or vertical line to help you compose level shots. You can also select the color.

[Grid Marker]

Displays a grid that allows you to frame your shots correctly (horizontally and vertically). You can also select the color.

[Aspect Marker]

Indicates various aspect ratios by displaying border lines or by masking the image outside the selected aspect ratio. The aspect ratio can be set freely by the user. A lower percentage value indicates lower mask opacity.

[Marker Aspect Ratio]

Sets the aspect ratio displayed with the [Aspect Marker] setting. By selecting [Custom], you can display the aspect marker ([Aspect Marker]) with a custom aspect ratio.

[Marker Custom Asp. Ratio]

Input the desired aspect ratio to be used when you select [Marker Aspect Ratio] > [Custom].

[Safe Area Marker]

Displays a margin from the edges of the image (using border lines or by masking the image) to indicate the action safe area, text safe area, etc. You can select the core area used as the basis for calculating the safe area and a percentage, relative to the side length or area. A lower percentage value indicates lower mask opacity.

[Basis for Marker Safe Area]

Selects the core area used as the basis for calculating the safe area when displaying [Aspect Marker].

[Whole Picture]

Sets the whole picture as the basis for calculating the safe area.

[Selected Aspect Marker]

Sets the area separated by the aspect marker as the basis for calculating the safe area.

[Marker Safe Area %]

Select the area where the safe area marker is displayed.

Note

Aspect markers will not be displayed when the aspect ratio for [Aspect Marker] is set to [16:9]. The same applies when the aspect ratio is set manually to [1.78:1] using [Custom].

System Settings

Configure advanced camera system settings such as video and audio, server, communications, and security. If you select the [System] menu in the settings area, the video display/operation area disappears and the following appears.

Screen Configuration

When the [System] menu is clicked, categories of the setting items are displayed on the left side of the screen, and the settings screen is displayed on the right side.

Categories of the setting items can also be displayed by clicking the  at the upper right of the screen.

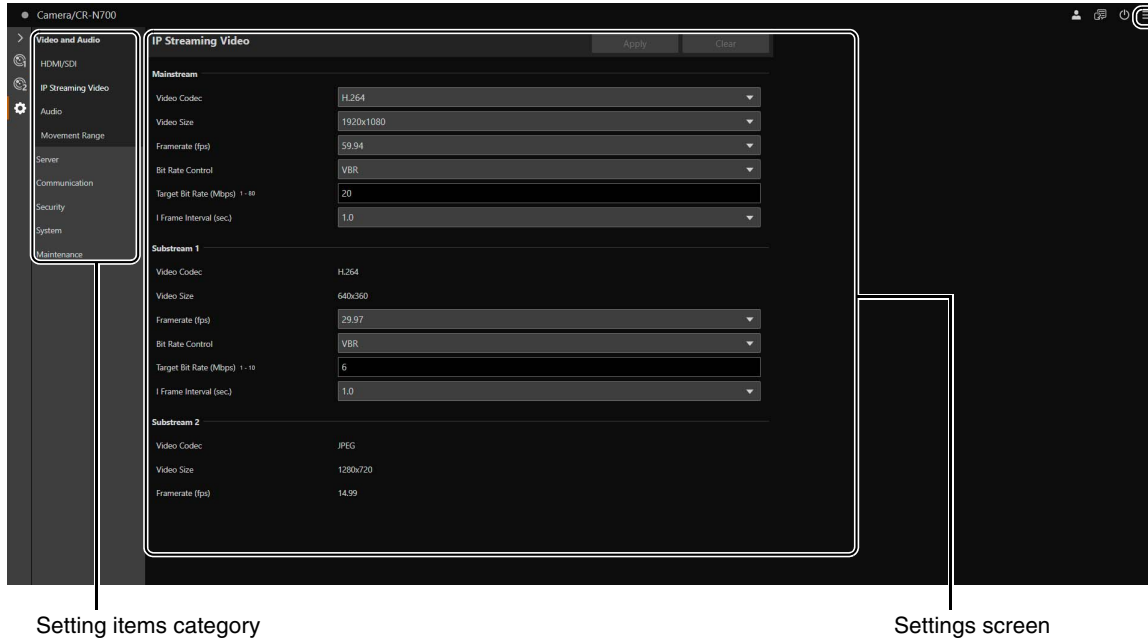

If the width of the screen is narrow, operations must be made from the  menu since the categories of the setting items are hidden.

Setting Items

The system setting items are summarized as follows:

Category	Item	Description
Video and audio	HDMI/SDI	Setting the common output signal method for HDMI/SDI and 3G-SDI mapping (P. 65)
	IP Streaming Video	General settings of the video, such as video size and quality sent from the camera (P. 67)
	Audio	Setting the bit rate for audio input from a microphone connected to the camera or IP audio streaming (P. 69)
	Movement Range	Pan/Tilt movement range settings (P. 71).
Server	HTTP/Video	Setting the HTTP Server and video server (P. 72)
	RTP	Communication setting using RTP Server (P. 73)
Communication	Network	Setting the network to which the camera is connected (P. 75).
	Wireless LAN	Setting the access point or IPv4 settings (P. 78) for direct connection of the camera and Wireless LAN enabled device.
	External Connection (IP)	Setting the communication protocol for IP connection of the camera with external devices such as controllers (P. 80).
	External Connection (serial)	Settings for serial connection of the camera (P. 84)
Security	Certificate Management	Settings for certificate creation and management (P. 86).
	SSL/TLS	Encrypted communications and server certificate settings (P. 87).
	User Management	Add/delete and set operating privileges for administrator account information and authorized users (P. 88).
	Host Access Restrictions	Setting separate access controls for access from IPv4 and IPv6 addresses (P. 90).
System	Camera	Settings for camera operation; camera name, installation conditions and others (P. 91).
	Add-On (Add-On Applications System)	Management of applications installed on the camera (P. 95).
	Date and Time	Camera date and time settings (P. 97).
	Environment	Settings for the frame frequency and maximum resolution (P. 99).
Maintenance	General	Device information and settings, license verification, reboot and initialization settings (P. 100).
	Backup/Restore	Perform backup and restoration (P. 102).
	Update Firmware	Perform firmware update (P. 104).
	Log	Log display and downloading message (P. 105).

Common Operations

Describes common operations in system settings.



Note

If a setting that does not display a dialog in a web browser is enabled, it may not be possible to operate the Settings Page. In this case, close and restart the web browser.

■ Applying Configuration Changes

When a setting is changed on the Settings Page, the [Apply] and [Clear] buttons in the upper right of the Settings Page are no longer grayed out and can be clicked.



In this situation, if [Apply] is clicked, the changed settings will be applied. Click [Clear] to revert to the previous settings.

■ Changes to Settings that Require to Reboot

Settings that require the camera to be restarted for the changed settings to take effect are indicated with a green [Reboot] symbol in the beginning.



When an item that has a [Reboot] symbol is changed, [Apply] in the upper right of the Settings Page changes to [Apply and Reboot].

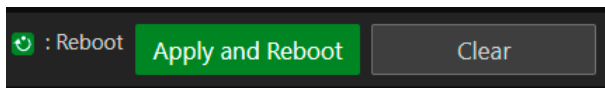

Click [Apply and Reboot] to apply the changes and restart the camera. Click [Clear] to revert to the previous settings.

Important

If switched to another settings screen without clicking [Apply] or [Apply and Reboot], changes will be lost. Be sure to click [Apply] or [Apply and Reboot] to apply changes.

■ Setting Range and Character Limit

For setting items for numeric values and characters, the allowable range and character limit are displayed. Enter within the displayed ranges.



[System] > [Video and Audio] > [HDMI/SDI]

Settings for the output signal format of the 12G-SDI OUT and HDMI™ OUT / 3G-SDI OUT terminals.

HDMI/SDI
Apply
Clear

HDMI/SDI Shared

12G-SDI 3840x2160/59.94P ▼

HDMI/3G-SDI 1920x1080/59.94P ▼

Crop

Crop 1 1920x1080

Crop 2 1920x1080

Output: 12G-SDI Full Screen

Output: HDMI/3G-SDI Full Screen Crop 1 Crop 2

SDI

3G-SDI Mapping Level A ▼

Time Code Output Enable ▼

HDMI/SDI Shared

Settings for the video output signal format for the 12G-SDI OUT terminal and HDMI OUT / 3G-SDI OUT terminal. 12G-SDI OUT terminal settings can be set separately. However, settings for the HDMI OUT and 3G-SDI OUT terminal are shared.

[12G-SDI], [HDMI/3G-SDI]

The video output format is set as a combination of the video size and frame rate.

The selectable HDMI/SDI video output format varies depending on the [Frame Frequency (Hz)] set in [System] > [System] > [Environment].

[Frame Frequency (Hz)]	Video output configuration (video size/frame rate)	
	12G-SDI OUT Terminal	HDMI OUT Terminal / 3G-SDI OUT Terminal
23.98	3840x2160/23.98P, 1920x1080/23.98P	3840x2160/23.98P*, 1920x1080/23.98P
29.97	3840x2160/29.97P, 1920x1080/29.97P, 1920x1080/29.97PsF	3840x2160/29.97P*, 1920x1080/29.97P
59.94	3840x2160/59.94P, 1920x1080/59.94P, 1920x1080/59.94i, 1280x720/59.94P, 720x480/59.94i	3840x2160/59.94P*, 1920x1080/59.94P, 1920x1080/59.94i, 1280x720/59.94P, 720x480/59.94P*
25.00	3840x2160/25.00P, 1920x1080/25.00P, 1920x1080/25.00PsF	3840x2160/25.00P*, 1920x1080/25.00P
50.00	3840x2160/50.00P, 1920x1080/50.00P, 1920x1080/50.00i, 1280x720/50.00P, 720x576/50.00i	3840x2160/50.00P*, 1920x1080/50.00P, 1920x1080/50.00i, 1280x720/50.00P, 720x576/50.00P*

* HDMI OUT terminal only.

The settings and options for each video stream vary depending on the selected video output format. See [System] > [Video and Audio] > [IP Streaming Video] for more information.

Note

When the video size is 3840x2160 or 720x480 (720x576), video is not output from the 3G-SDI OUT terminal.

Crop

Sets output settings for the cropped areas.

[Crop 1], [Crop 2]

Sets the resolution for each cropped area. Depending on the [HDMI/SDI Shared] > selected video output configuration, resolution is displayed as fixed.

[Output: 12G-SDI], [Output: HDMI/3G-SDI]

Available settings for [Crop] > [Output: 12G-SDI] and [Output: HDMI/3G-SDI] are displayed automatically according to the settings for [Crop 1] and [Crop 2].

SDI

Settings for the output signal method of the SDI terminals.

[12G-SDI Mapping], [3G-SDI Mapping]

When the [HDMI/SDI Shared] > selected video output configuration is [1920x1080/59.94P] or [1920x1080/50.00P], select the mapping level of the output signal of the 12G-SDI OUT and 3G-SDI out terminals. A signal conforming to Level A or Level B of the SMPTE ST 425-1 standard is outputted.

[Time Code Output]

Set to [Enable] to superimpose the timecode on the SDI terminal output.

[System] > [Video and Audio] > [IP Streaming Video]

Settings for the general video settings such as size and quality for the video to be distributed via IP. Settings are made for each of the following three streams.

- Mainstream
- Substream 1
- Substream 2

The screenshot shows the 'IP Streaming Video' configuration window with three sections: Mainstream, Substream 1, and Substream 2. Each section has a set of configuration options.

Stream	Video Codec	Video Size	Framerate (fps)	Bit Rate Control	Target Bit Rate (Mbps)	I Frame Interval (sec.)
Mainstream	H.264	1920x1080	59.94	VBR	20	1.0
Substream 1	H.264	640x360	29.97	VBR	6	1.0
Substream 2	JPEG	1280x720	14.99			

The options for [Video Size] and [Framerate (fps)] that can be selected for each video stream vary depending on the frame frequency set in [System] > [System] > [Environment].

Mainstream

Set the Mainstream video to be distributed from the camera.

[Video Codec]

Select the video codec type.

In the following case, the video codec is H.264.

- [System] > [Communication] > [External Connection (IP)] > [RTMP] is [Enable]

Note

- If [I Frame Interval (sec.)] is set to [ALL-I], [H.265] cannot be set.
- When [Video Size] is set to [3840x2160] and [Framerate (fps)] is set to [59.94] or [50.00], cannot be set to [H.264].

[Video Size]

Select a video size.

[Framerate (fps)]

Select the frame rate of the video.

[Bit Rate Control]

Settings for the video bit rate.

In order to control the bit rate strictly in an environment subject to limitations such as the bandwidth, set to [CBR].

Note

When [Video Size] is set to [3840x2160] and [Framerate (fps)] is set to [59.94] or [50.00], cannot be set to [CBR].

[Target Bit Rate (Mbps)]

Enter the target value of the bit rate when [Bit Rate Control] is set to [CBR].

Enter a bit rate as an image quality target when [Bit Rate Control] is set to [VBR]. Depending on the video, the set bit rate may be exceeded.

The maximum value that can be entered differs depending on the settings of [Video Size] and [Framerate (fps)].

[I Frame Interval (sec.)]

Select the interval in seconds to insert an I frame into the video selected in [Video Codec]. Specify [ALL-I] if wanting all frames to be I-frames.

Note

When [Video Codec] is set to [H.265], [ALL-I] cannot be set.

Substream 1

Settings for the video of Substream 1 to be distributed from the camera.

[Video Codec]

H.264 is fixed.

[Video Size]

640 x 360 is fixed.

[Framerate (fps)], [Bit Rate Control], [Target Bit Rate (Mbps)], [I Frame Interval (sec.)]

Refer to each item of [Mainstream].

Note

[Framerate (fps)] of Substream 1 cannot be set to [59.94] or [50.00].

Substream 2

Settings for the video of Substream 2 to be distributed from the camera.

[Video Codec]

JPEG is fixed.

[Video Size]

1280 x 720 is fixed.

[Framerate (fps)]

The set value is displayed according to the frame frequency.

[System] > [Video and Audio] > [Audio]

Settings for the audio input from the microphone connected to the camera and for the bit rate for IP audio streaming.

Audio Apply Clear

General Audio

Audio Input: Enable

Audio Input Mode: MIC Terminal/MIC

Input Volume 1 - 100: 50

Current Volume Level (L): [Slider]

Current Volume Level (R): [Slider]

Attenuator: Disable

IP Audio Streaming

Distribution Bit Rate (kbps): 128

General Audio

Settings for the volume of the audio input and the type of microphone.

[Audio Input]

Select whether to use audio from the microphone.

When [Disable] is selected, Audio cannot be outputted from HDMI/SDI output.

Note

To set [Audio Input] to [Disable], all of the following settings must be changed to [Disable].

- [System] > [Server] > [RTP Server] > Each stream (Main, Sub1, Sub2) > [Audio Transmission]
- [System] > [Communication] > [External Connection (IP)] > [NDI|HX] > [Audio Transmission]
- [System] > [Communication] > [External Connection (IP)] > [RTMP] > [Audio Stream]
- [System] > [Communication] > [External Connection (IP)] > [SRT] > [Audio Stream]

[Audio Input Mode]

Select the type of microphone to connect to the camera: input terminals (INPUT/MIC), input method (LINE/MIC), and with or without power to the microphone.

Setting Value	Input Terminal	Input Method	Power to Microphone
MIC Terminal/LINE	MIC	LINE	-
MIC Terminal/MIC	MIC	MIC	Not Supported
MIC Terminal/MIC (MIC Power On)	MIC	MIC	Supported
INPUT Terminal/LINE	INPUT	LINE	-
INPUT Terminal/MIC	INPUT	MIC	Not Supported
INPUT Terminal/MIC+48V	INPUT	MIC	+48V

Note

To use a microphone that requires phantom powering, turn it on while connected, and then set it to [INPUT Terminal/MIC+48V].

Caution

When using a microphone, set [Audio Input Mode] correctly according to the specifications of the microphone.

Failure to do so may damage the camera or microphone.

[Input Volume]

Settings for the volume to be inputted from the microphone connected to the camera.

[Current Volume Level (L)], [Current Volume Level (R)]

Displays the current volume level in the status bar.

[Attenuator]

Select whether to use the attenuator (20 dB) when the MIC input method is selected for [Audio Input Mode].

IP Audio Streaming

Features settings for IP Audio streaming.

[Distribution Bit Rate (kbps)]

Select the bit rate for distribution.



Important

- Video and audio may not be synchronized.
- Depending on the performance of the computer and the network environment, audio may be choppy.
- If using antivirus software, audio may be choppy.
- If communication is temporarily interrupted by reseating of the LAN cable for example, the audio will be disconnected. In this case, reconnect the device to the camera.

[System] > [Video and Audio] > [Movement Range]

Settings for the pan/tilt movement range.

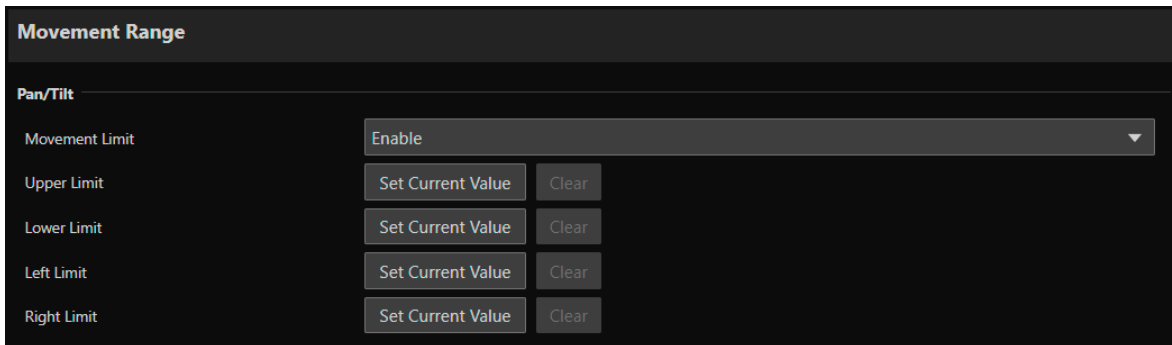

The screenshot shows a dark-themed settings window titled "Movement Range". Under the "Pan/Tilt" section, there is a "Movement Limit" dropdown menu currently set to "Enable". Below this, there are four rows of controls for "Upper Limit", "Lower Limit", "Left Limit", and "Right Limit". Each row contains two buttons: "Set Current Value" and "Clear".

Limit Type	Set Current Value	Clear
Movement Limit	Enable	
Upper Limit	Set Current Value	Clear
Lower Limit	Set Current Value	Clear
Left Limit	Set Current Value	Clear
Right Limit	Set Current Value	Clear

Pan/Tilt

It is possible to limit the pan/tilt movement range.

[Movement Limit]

When set to [Enable], pan/tilt movement range for all operations is limited, including preset/trace execution and Add-On application operations.

[Upper Limit], [Lower Limit], [Left Limit], [Right Limit]

When [Movement Limit] is set to [Enable], sets or clears the pan/tilt movement limit (top, bottom, left, and right edges).

Click [Set Current Value] for each edge to set the current pan/tilt position as the limit.

Click [Clear] to clear the movement limit.

[System] > [Server] > [HTTP/Video]

Setting for the HTTP Server for distributing Settings Page and videos over the network, and video distribution via HTTP.

HTTP/Video Reboot Apply Clear

HTTP Server

Authentication Method: Digest Authentication

HTTP Port: 80

HTTPS Port: 443

Video Server

Maximum Number of Clients: 15

Maximum Connection Time (sec.): 0

HTTP Server

Settings for the authentication method and HTTP port.

Important

A confirmation dialog will appear when the [HTTP port] or [HTTPS port] settings are changed, and the connection to the camera from the active web browser may become disabled. If the changed settings are to be applied, click [OK].

If unable to reconnect to the camera from the web browser after restarting the camera, a message appears with a suggested URI, if any, to reconnect to the camera.

If unable to connect to the camera through the displayed URI, contact your system administrator.

[Authentication Method]

Select the authentication method to be used by the HTTP Server.

[HTTP Port]

Enter the HTTP port.

In general, use [80] (factory default setting).

[HTTPS Port]

Enter the HTTPS port.

In general, use [443] (factory default setting).

Video Server

Settings for clients which can connect to the Video Server.

[Maximum Number of Clients]

Enter the maximum number of clients that can connect to the camera simultaneously.

If [0] is entered, only the administrator is allowed to connect.

Important

If there are many clients to distribute, the video frame rate may decrease or the audio may be cut off.

[Maximum Connection Time (sec.)]

Enter the maximum time, in seconds, that individual client can connect to the camera.

If [0], the connection time is unlimited.

[System] > [Server] > [RTP]

Settings for video and audio streaming using RTP.

RTP

RTP Server

RTP: Enable

RTSP Authentication Method: Digest Authentication

RTSP Port: 54,104 ~ 65535: 554

Audio Settings

Audio Compression Method: AAC-LC 48kHz

Multicast Address: 0.0.0.0

Multicast Port: 0,1024 ~ 65535 (even numbers only): 0

Multicast TTL: 0 ~ 255: 1

RTP Mainstream

Video Type: H.264 192x1080

Multicast Address: 0.0.0.0

Multicast Port: 0,1024 ~ 65535 (even numbers only): 0

Multicast TTL: 0 ~ 255: 1

Audio Transmission: Enable

RTP Substream 1

Video Type: H.264 640x360

Multicast Address: 0.0.0.0

Multicast Port: 0,1024 ~ 65535 (even numbers only): 0

Multicast TTL: 0 ~ 255: 1

Audio Transmission: Enable

RTP Substream 2

Video Type: H.264 1280x720

Multicast Address: 0.0.0.0

Multicast Port: 0,1024 ~ 65535 (even numbers only): 0

Multicast TTL: 0 ~ 255: 1

Audio Transmission: Enable

RTP Server

Settings for use of RTP, RTSP authentication method and port number.

[RTP]

Select whether to use RTP.

[RTSP Authentication Method]

Select a RTSP authentication method. Since RTSP authentication method is set independently from HTTP Server authentication method, it is necessary to configure the setting for each authentication method.

[RTSP Port]

Enter the RTSP port.

In general, use [554] (factory default settings).

Audio Settings

Settings for multicast audio transmission.

[Audio Compression Method]

Displays the audio compression method and the frequency. [AAC-LC 48kHz] as fixed value.

[Multicast Address]

Enter multicast address for audio transmission as follows.

IPv4: in the range of 224.0.0.0 to 239.255.255.255

IPv6: address starting with ff00::/8

[Multicast Port]

Enter multicast port for audio transmission.

[Multicast TTL]

Enter the effective range for multicast distribution.

The TTL (Time To Live), representing the effective range for multicast distribution, is decremented each time the signal passes through a router. When it reaches 0, distribution through a router becomes impossible.

For example, if TTL is set to [1], multicast distribution is confined to the local segment only and cannot pass through the router.



Note

With one of the following settings, audio multicast distribution is disabled.

- Set [0.0.0.0] (IPv4) or [::0::] (IPv6) for [Multicast Address].
- Set [0] for [Multicast Port] or [Multicast TTL].

RTP Mainstream, RTP Substream 1, RTP Substream 2

Settings for RTP stream distribution, to be configured for each stream.

[Video Type]

Displays [Video Codec] and [Video Size] set for each video stream in [System] > [Video and Audio] > [IP Streaming Video].

[Multicast Address]

Enter multicast address for RTP stream as follows.

IPv4: in the range of 224.0.0.0 to 239.255.255.255

IPv6: address starting with ff00::/8

[Multicast Port]

Enter multicast port for RTP stream.

[Multicast TTL]

Enter the effective range for multicast distribution of RTP stream.

The TTL (Time To Live), representing the effective range for multicast distribution, is decremented each time the signal passes through a router. When it reaches 0, distribution through a router becomes impossible.

For example, if TTL is set to [1], multicast distribution is confined to the local segment only and cannot pass through the router.

[Audio Transmission]

Select whether to use the audio transmission of RTP stream.

When [Disable] is set for [System] > [Video and Audio] > [Audio] > [General Audio] > [Audio Input], [Enable] cannot be set.



Note

- With one of the following settings, the multicast distribution of RTP stream is disabled.
 - Set [0.0.0.0] (IPv4) or [::0(::)] (IPv6) for [Multicast Address] .
 - Set [0] for [Multicast Port] or [Multicast TTL].
- URL for RTP stream
rtsp://IP address: port/rtpstream/config1(to 3)
Example: rtsp://192.168.100.1:554/rtpstream/config1
 - Distribution method depends on the request for distribution from the RTP client application.
 - config1 requests the distribution of Mainstream, config2 requests Substream 1, and config3 requests Substream 2.
- Video quality of [Bit Rate Control] of Main and Sub1 uses the settings in [System] > [Video and Audio] > [IP Streaming Video] (P. 67)
- [Video Distribution] in [System]> [Security]> [User Management]> [User Authority] is not reflected in RTP.
- In an environment using proxy server or firewall, the video from the RTP stream may not be displayed. In such a case, contact your system administrator.
- When the host access restriction is applied to a client during the RTP over UDP stream distribution, it may take from a few seconds to several tens of seconds to stop the distribution.

[System] > [Communication] > [Network]

Settings for connecting to the network.

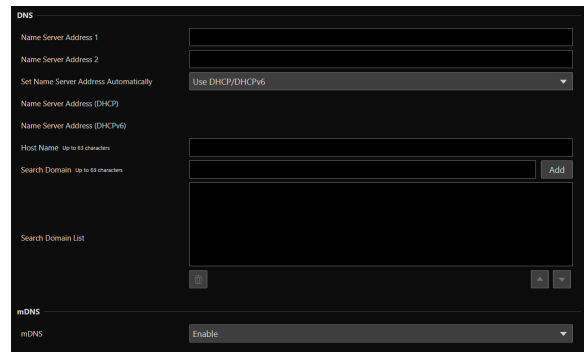
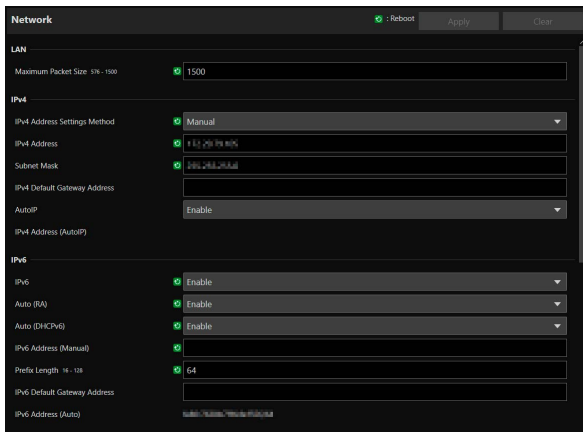

Important

If changing settings related to network connection, it might not be possible to connect to the camera from the web browser. In this case, by clicking [Apply] or [Apply and Reboot], a dialog for confirmation will be displayed. Click [OK] to apply the change. If unable to reconnect to the camera from the web browser after the camera is restarted due to a configuration change, a message appears with a suggested URI, if any to reconnect to the camera. If unable to connect to the camera through the displayed URI, contact the system administrator.

LAN

Settings for the transmission data size from the camera.

[Maximum Packet Size]

Enter the maximum size for the packets transmitted from the camera. In general, it is not necessary to change from 1500. When using IPv6, it is necessary to set 1280 or higher.

When using ADSL, by slightly decreasing the value, transmission efficiency may be improved.

IPv4

Settings for connection to the camera by IPv4. IPv4 address can be acquired automatically from the DHCP Server or can be set manually.

Important

- Regarding [IPv4 Address], [Subnet Mask] and [IPv4 Default Gateway Address] for manual setting of IPv4, contact your system administrator.
- If there is any error in the settings of [IPv4 Address], [Subnet Mask] or [IPv4 Default Gateway Address], access via network may not be possible. In such a case, search cameras using the Camera Search Tool, and set the address again.

[IPv4 Address Settings Method]

Select the IPv4 address settings method.

For [Manual], enter a fixed IPv4 address to [IPv4 Address].

For [Auto (DHCP)], a value acquired from DHCP Server will be set automatically to [IPv4 Address (DHCP)] and [IPv4 Default Gateway Address (DHCP)].

Important

When using IPv4 address settings in [Auto (DHCP)], in an environment with a router between the DHCP Server and the camera, IPv4 address may not be assigned correctly. In such a case, select [Manual] to set the fixed IPv4 address.

[IPv4 Address]

When [IPv4 Address Settings Method] is [Manual], enter the fixed IPv4 address.

[Subnet Mask]

When [IPv4 Address Settings Method] is [Manual], enter the subnet mask value specified for each network.

[IPv4 Default Gateway Address]

When [IPv4 Address Settings Method] is [Manual], enter a value. Make sure to set, when connecting the camera to a subnet different from IP connection device such as controller.

[AutoIP]

Select whether to use AutoIP. When the AutoIP address is enabled, IP address automatically set will be displayed in [IPv4 Address (AutoIP)].

IPv6

Settings for connection to the camera using IPv6. IPv6 address can be acquired automatically from the RA or the DHCPv6 Server, or can be set manually.

Important

Regarding [IPv6 Address (Manual)], [Prefix Length] and [IPv6 Default Gateway Address] for manual setting of IPv6, contact your system administrator.

[IPv6]

Select whether to use IPv6,

[Auto (RA)]

Select [Enable], when automatically setting the address using RA (Router Advertisement, network information transmitted automatically from the router).

[Auto (DHCPv6)]

Select [Enable], when automatically setting the address using DHCPv6.

[IPv6 Address (Manual)]

For setting the address manually, enter a fixed IPv6 address.

[Prefix Length]

For setting the address manually, enter a prefix length.

[IPv6 Default Gateway Address]

For setting the address manually, enter a default gateway address. Make sure to set, when connecting the camera to a subnet different from IP connection device such as controller.

[IPv6 Address (Auto)]

When [IPv6] is [Enable] and [Auto (RA)] or [Auto (DHCPv6)] is [Enable], the address automatically acquired will be displayed.

DNS

Settings for the DNS Server address. DNS Server address can be set manually or can be acquired automatically from the DHCP/DHCPv6 Server.

[Name Server Address 1], [Name Server Address 2]

Enter the name server address to be registered. When only one address is to be registered, leave [Name Server Address 2] blank.

Note

If [Name Server Address 1] cannot be used, make access to [Name Server Address 2]. However, it is assumed that [Name Server Address 2] set beforehand.

[Set Name Server Address Automatically]

Select the server for setting automatically the name server address.

When using DHCP, set [IPv4 Address Settings Method] to [Auto (DHCP)] (P. 75).

When using DHCPv6, set [IPv6] to [Enable] and [Auto (DHCPv6)] to [Enable] (P. 76).

[Name Server Address (DHCP)]

When [Set Name Server Address Automatically] is set as [Use DHCP] or [Use DHCP/DHCPv6], the name server address acquired from the DHCP Server will be displayed.

[Name Server Address (DHCPv6)]

When [Set Name Server Address Automatically] is set as [Use DHCPv6] or [Use DHCP/DHCPv6], the name server address acquired from the DHCPv6 Server will be displayed.

[Host Name]

The host name of the camera can be registered with alphanumeric characters to the name server.

[Search Domain]

When adding a domain name to the search domain list, enter the domain name and click [Add].

If a domain name is specified in the search domain list, it will be handled in the form of host name + domain name simply by specifying the host name without the domain name in the specified server such as NTP and RTMP.

[Search Domain List]

Displays a list of domain names added in [Search Domain].

Queries are sent to the DNS Server in order from the top of the list of domain names.

With the ▲ or ▼ button on the right, the order of the domain names can be changed.

Select a domain name and click  to delete the domain name.

mDNS

Settings for use of multicast DNS. When using mDNS, IP address and host name information of the camera is notified to other hosts on the network.

[mDNS]

Select whether to use mDNS.

For using NDI|HX as a communication protocol (P. 80), set [mDNS] to [Enable].

[System] > [Communication] > [Wireless LAN]

Settings for the access point for directly connecting the camera and the wireless LAN supported devices. By setting different IP addresses for the Wireless LAN and the Wired LAN, it possible to choose and use according the purposes.

Wireless LAN 🔄 : Reboot Apply Clear

Interface

Wireless LAN Enable

Access Point

SSID Up to 32 characters XXXXX

Authentication Method WPA2-PSK/WPA3-SAE mix

Password 8 to 63 characters *****

Confirm Password 8 to 63 characters *****

Channel Setting 1

IPv4

IPv4 Address 🟢 192.168.1.1

Subnet Mask 🟢 255.255.255.0

Interface

Settings for use of the wireless LAN.

[Wireless LAN]

Select whether to use the wireless LAN.

Access Point

When [Wireless LAN] is set as [Enable], set the SSID and the authentication method etc., so that the camera functions as the access point.

[SSID]

Enter the network name (SSID). Enter in single-byte alphanumeric characters, numbers, or symbols.

[Authentication Method]

Fixed as WPA2-PSK/WPA3-SAE mix.

[Password]

Enter a password for the access point. Enter in single-byte alphanumeric characters, numbers, or symbols.

[Confirm Password]

Enter the same password as above for confirmation.

[Channel Setting]

When connecting multiple devices at the same frequency, set the channel to avoid radio interference.



Note

If the SSID is changed, it is also required to change the password.

IPv4

Settings of IPv4 for connecting the wireless LAN and the wired LAN at the same time.

[IPv4 Address]

Enter the fixed IPv4 address.

[Subnet Mask]

Enter specified subnet mask value for each network.



Note

The wireless connection must be on a different subnet than the wired LAN. If the specified IP address is in the same subnet as the wired LAN, an error occurs.

[System] > [Communication] > [External Connection (IP)]

Settings for communication for connecting controllers, etc. via IP.

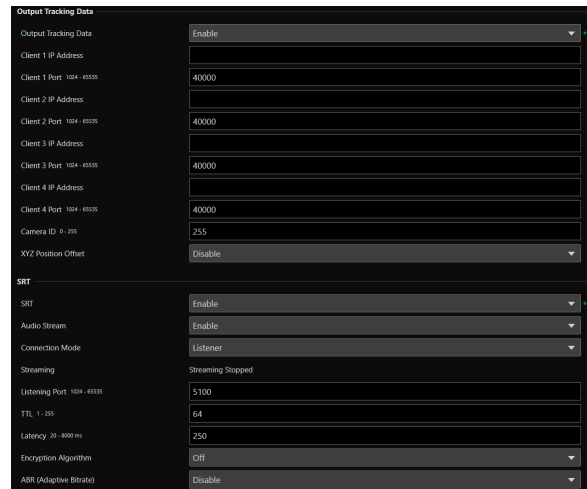
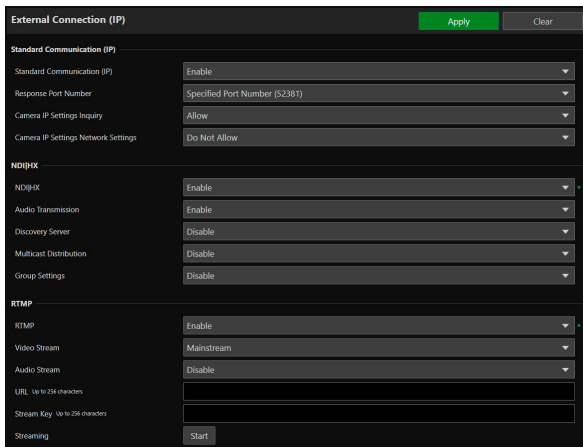

Standard Communication (IP)

Settings for operating the cameras from the controller connected by the standard IP communication.

[Standard Communication (IP)]

Select whether to use [Standard Communication (IP)] for the connection with the controller.

[Response Port Number]

Select whether to use a fixed port number (52381) or a source port number when communicating with the controller.

[Camera IP Settings Inquiry]

Select whether to allow the inquiry on the camera IP settings from the controller.

[Camera IP Settings Network Settings]

Select whether to allow to change the network settings of the camera from the controller.

NDI|HX

Settings for exchanging data with NDI|HX supported devices.

[NDI|HX]

Select whether to use [NDI|HX] as the communication protocol.

For setting to [Enable], go to [System] > [Communication] > [Network] > [mDNS] and select [Enable] (P. 77).

[Audio Transmission]

Select whether to use the audio transmission.

When [Disable] is set for [System] > [Video and Audio] > [Audio] > [General Audio] > [Audio Input], [Enable] cannot be set.

[Discovery Server]

Select whether to use the Discovery Server.

When set to [Enable], it notifies the Discovery Server only of the IP address and does not notify other hosts of the IP address nor hostname.

[Discovery Server IP Address]

Enter the IP address of the Discovery Server.

[Multicast Distribution]

Select whether to use the multicast distribution.

Note

For multicast distribution, set the multicast distribution enabled in the NDI client side as well.

[Multicast TTL]

Enter the effective range for multicast distribution.

The TTL (Time To Live), representing the effective range for multicast distribution, is decremented each time the signal passes through a router. When it reaches 0, distribution through a router becomes impossible.

For example, if TTL is set to [1], multicast distribution is confined to the local segment only and cannot pass through the router.

[Group Settings]

Select whether to use the group settings.

When a group name to which the camera belongs is specified, the camera connects only to NDI clients with the same group name.

[Group Name], [Group List]

Enter the group name.

By clicking [Add], the entered group name will be displayed in the group list.

Able to sort the list items in ascending order by clicking  and in descending order by clicking .

Select a group in the group list and click  to delete the group.

RTMP

A communication protocol for the streaming playback of video and audio, and sending and receiving the data.

[RTMP]

Select whether to use [RTMP] as the communication protocol.

Note

When [H.265] is set for [System] > [Video and Audio] > [IP Streaming Video] > [Mainstream] > [Video Codec], RTMP cannot be used.

[Video Stream]

Select the type of the video stream. Substream 2 cannot be used.

[Audio Stream]

Select whether to use the audio stream.

When [Disable] is set for [System] > [Video and Audio] > [Audio] > [General Audio] > [Audio Input], [Enable] cannot be set.

[URL]

Enter the URL of the server set on the distribution server side.

Enter the string of characters starting with rtmp:// or rtmps://.

[Stream Key]

Enter the stream key set on the distribution server side.

[Streaming]

By clicking [Start] to start the streaming, the button becomes [Stop].

By clicking [Stop], the streaming ends.

Output Tracking Data

Configures the output of camera tracking data (pan, tilt, zoom, etc.) required when using the virtual studio system in a format compliant with the free-d protocol. The supported message type is Type D1.

[Output Tracking Data]

Select whether to use the camera's Output Tracking Data.

[Client (1 to 4) IP Address]

Enter the IP address of the client that will receive the camera tracking data.

[Client (1 to 4) Port]

Enter the number corresponding to each [Client (1 to 4) IP Address].

[Camera ID]

Enter the ID that identifies the camera. Be sure to use single-byte numeric characters.

[XYZ Position Offset]

Select whether to specify the camera position.

[X], [Y], [Z]

Enter the value for each.

Note

- The data to be stored and output are as follows. When a still image is displayed during preset movement, values other than Camera ID and Checksum are not changed.
Camera ID: Stores the ID set in [Camera ID].
Camera Pan Angle / Camera Tilt Angle / Camera Roll Angle: Stores the camera angles in the format specified by the free-d protocol.
 - Pan: -170° to 170°
 - Tilt: -30° to 90°
 - Roll: Angle: 0° (fixed)Camera X-Position / Camera Y-Position / Camera Height (Z-Position) : Stores the value set in [XYZ Position Offset].
Camera Zoom: Stores Zoom type and zoom position.
Camera Focus: Stores the Focus value.
Spare/Undefined Data: Stores the iris value.
Checksum: Stores the Checksum value calculated by the method specified in the free-d protocol.
- If [G-LOCK/SYNC Term.] is [Genlock Input], packets are sent along with the genlock signal.
- If lag occurs in the camera tracking data's transmission interval, it may be stabilized by closing the Settings Page or stopping IP streaming.
- If you output tracking data to multiple clients, the data is sent in order starting with the lowest client number.
To avoid a delay between transmissions, use a lower client number. The amount of delay depends on the system and network conditions.

SRT

Configures settings for exchanging data with SRT (Secure Reliable Transport) compliant devices.

[SRT]

Select whether to use [SRT] as the communication protocol.

[Audio Stream]

Select whether to use the audio stream.

When [Disable] is set for [System] > [Video and Audio] > [Audio] > [General Audio] > [Audio Input], [Enable] cannot be set.

[Connection Mode]

Sets the connection mode of the camera. Select [Caller] if you want the camera to connect to an external device, or select [Listener] if you want the camera to listen for connections from an external device.

[Streaming]

If the [Connection Mode] is [Caller], clicking [Start] will start the streaming and the button will be [Stop]. By clicking [Stop], the streaming ends.

[Destination], [Destination Port]

Enter the IP address/host name/port number of the connection destination when [Connection Mode] is [Caller].

[Listening Port]

Enter the port number of the connected device when [Connection Mode] is [Listener].

[TTL]

Enter the TTL (Time To Live) of the packet.

The TTL, which represents the valid range of the packet, is decremented by 1 each time it crosses a router, and when it reaches 0, it cannot be delivered beyond the router. For example, setting the TTL to [1] results in delivery only to a local segment.

[Latency]

Sets the delay time for SRT delivery. Delay time is the time it takes for a lost packet to be recovered. The unit is "ms" (milliseconds).

[Stream ID]

Sets an ID to identify the stream when [Connection Mode] is [Caller]. Enter in single-byte alphanumeric characters, numbers, or symbols.

[Encryption Algorithm]

Select the encryption algorithm (AES-128 / AES-192 / AES-256 / Off).

**Important**

When using encryption, the [Mainstream] > [Target Bit Rate (Mbps)] setting will be restricted.

[Passphrase]

Sets the passphrase to be used for encryption. Enter in single-byte alphanumeric characters, numbers, or symbols. The same passphrase as the connected device must be set.

[ABR (Adaptative Bitrate)]

Dynamically changes the bit rate within the target bit rate range (P. 67), depending on the network bandwidth. Reduces video pauses and distortion caused by network congestion.

[System] > [Communication] > [External Connection (Serial)]

Settings for communication by the serial connection of controllers, etc.

External Connection (Serial)	
Serial Port	
Serial Port	Enable
Serial Port Connection Type	RS422
Baud Rate (bps)	9600
Data Length (bit)	8
Start Bit (bit)	1
Stop Bit (bit)	1
Parity	None
Standard Communication (Serial)	
Standard Communication (Serial)	Enable
Serial Device Address	Auto

Note

Connect the Remote Camera Controller RC-IP100/RC-IP1000 via IP. This camera cannot be controlled by the serial connection.

Serial Port

Detail settings for the serial port.

[Serial Port]

Select whether to use the serial port.

[Serial Port Connection Type]

RS-422 as fixed value.

[Baud Rate (bps)]

Select the Baud Rate value.

[Data Length (bit)]

Data length of serial communication is fixed at 8 bit.

[Start Bit (bit)]

The length of the start bit is fixed at 1 bit.

[Stop Bit (bit)]

The length of the stop bit is fixed at 1 bit.

[Parity]

The settings for the error detection code is fixed to None

Note

In the next item, if the [Standard Communication (Serial)] is set as [Enable], the settings for the baud rate of the serial communication, data length, stop bit, and parity will be changed as follows.

- Baud rate : Speed of Standard Communication (Serial)
- Data length (bit) : 8
- Stop bit (bit) : 1
- Parity : None

Standard Communication (Serial)

Settings for connection with standard serial communication.

[Standard Communication (Serial)]

Select whether to use standard serial communication.

[Serial Device Address]

Select the address of the camera.

When [Auto] is selected, addresses will be automatically assigned.

[System] > [Security] > [Certificate Management]

Manage the server certificates. It is also possible to create a self-signed certificate to use, for example, for operation test.

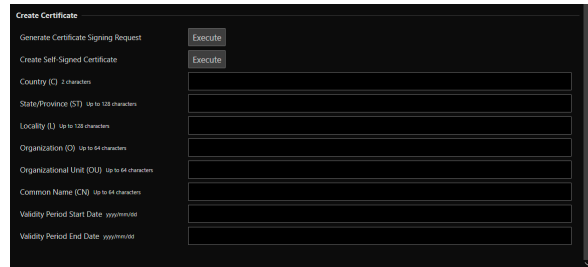
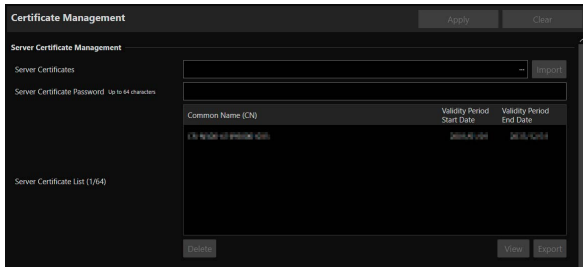

Server Certificate Management

Manage the server certificates.

[Server Certificates]

Perform this operation to import server certificates.

Click [...] and specify the certificate file to be imported, and then click [Import].

[Server Certificate Password]

Set the password to use when importing and exporting the server certificate.

[Server Certificate List]

Click [View] to display the information of server certificates, as a list. Certificate's validity is displayed in GMT (Greenwich Mean Time).

Specify the certificate and click [Export] to export the certificate information. Click [Delete] to delete it from the list.

Create Certificate

Create server certificates.

Important

It is advised to use self-signed certificate for such as operation tests that do not require full security. It is recommended to acquire and install a server certificate issued from CA for a full-scale system operation.

[Generate Certificate Signing Request]

Click [Execute] to create a server private key and generate a certificate signing request.

Once processed, the certificate signing request will be displayed in a separate window.

[Create Self-Signed Certificate]

Enter the following items, click [Apply], and click [Execute] to create a self-signed certificate.

Note

Creating a certificate takes time, so it is recommended to stop the video distribution processes etc.

[Country (C)]

Enter the ISO3166-1 alpha-2 country code.

[State/Province (ST)], [Locality (L)], [Organization (O)], [Organizational Unit (OU)], [Common Name (CN)]

Enter state/province name, locality, organization name, organizational unit and common name in alphanumeric characters (spaces or printable characters).

Enter an FQDN format host name, etc. to set the common name (required).

[Validity Period Start Date], [Validity Period End Date]

Set the validity period of the certificate to be created (required when creating a self-signed certificate).

[System] > [Security] > [SSL/TLS]

Settings for encrypted communications and server certificates.

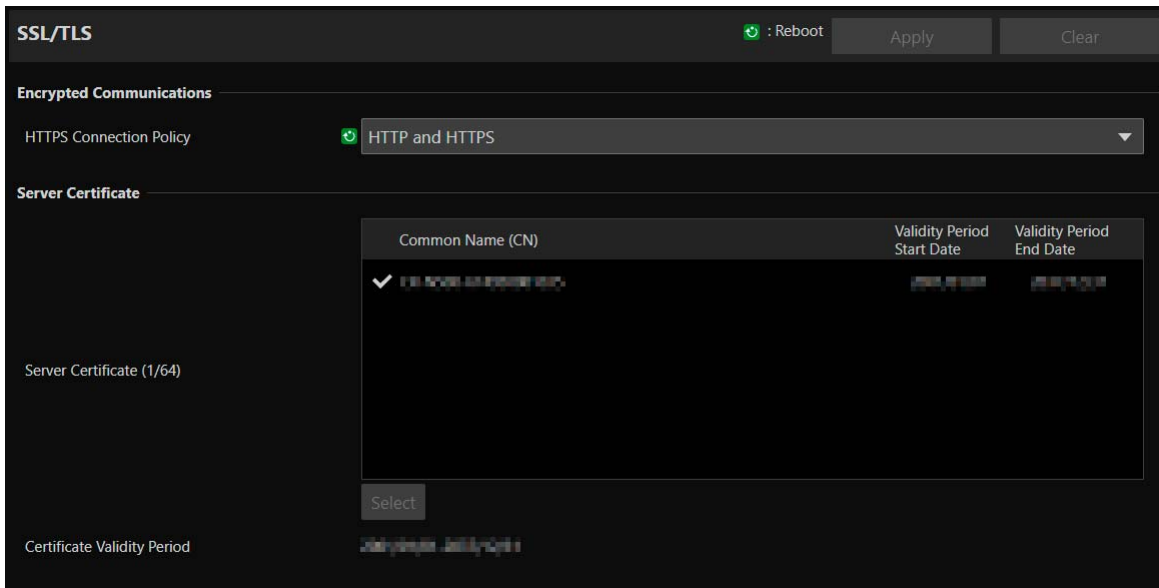

Encrypted Communications

Settings for encrypted communications.

[HTTPS Connection Policy]

Set SSL/TLS communication with HTTPS connections.

Select [HTTP] if SSL/TLS communication is not performed.

Select [HTTPS] or [HTTP and HTTPS] to perform SSL/TLS communication. Connections using SSL/TLS are enabled after rebooting.

If [HTTPS] is selected, HTTP access is also redirected to HTTPS to perform SSL/TLS communication.

Important

- Even if SSL/TLS communication is set to use here, SSL/TLS communication is not performed unless a certificate has not been installed.
- Video distribution performance decreases when performing SSL/TLS communication.

Server Certificate

Settings for server certificate for use.

[Server Certificates]

Select a certificate to use from the certificates registered in [System] > [Security] > [Certificate Management] > [Server Certificate Management], and click [Select]. The selected certificate will take effect after the reboot.

[Certificate Validity Period]

Displays the validity period of the selected certificate.

Note

Depending on the server certificate used by the camera and the computer connected to the camera, it may be necessary to install the root certificate, the intermediate CA certificate, or the certificate selected and exported in [Server Certificate List].

[System] > [Security] > [User Management]

Settings for account to access the camera via an IP connection, such as from a controller.

The screenshot shows the 'User Management' interface with the following sections:

- Administrator Account:** Fields for Administrator Name (5 to 15 characters), Password (8 to 32 characters), and Confirm Password (8 to 32 characters).
- Authorized User Account:** Fields for User Name (5 to 15 characters), Password (8 to 32 characters), and Confirm Password (8 to 32 characters), followed by an 'Add' button.
- User List:** A large empty box with a trash icon and sort buttons (A-Z and Z-A).
- User Authority:** A table with columns for 'Camera Control' and 'Video Distribution', and rows for 'Authorized User' and 'Guest User'. Both rows have checked boxes in both columns.

	Camera Control	Video Distribution
Authorized User	<input checked="" type="checkbox"/>	<input checked="" type="checkbox"/>
Guest User	<input checked="" type="checkbox"/>	<input checked="" type="checkbox"/>

"Administrator", "authorized user", and "guest user" are the three types of accounts that are able to access the camera. For the minimum user settings and permissions required, refer to "Measures Suitable to the Users' Environment 1: User Management" (P. 138).

Administrator:

The administrator can access the Settings Page for all settings including granting privileges to authorized users and guest users. Access the camera with the administrator name and password registered with administrator account.

Authorized User:

This account is used to access the camera by authenticating with a user name and password. It is required to enter a user name and password of the controller or other connecting devices.

Guest User:

The account is used to access the camera without user authentication.

Important

- Multiple administrator accounts cannot connect to a camera at the same time.
- Authorized user and guest user accounts can connect to the camera from multiple devices at the same time.
- When using NDI|HX, RTMP, or SRT, access cannot be controlled by [User Management].

Administrator Account

Settings for changing the administrator account information that was set at initial setting.

Important

- To ensure system security, set the administrator password that should not be easily guessed by third parties. Be sure not to forget the new password.
- If administrator password is forgotten, restore to the factory default settings (P. 124). Note, however, that this will reset all camera settings to factory default settings including the administrator account, the network information, date and time.

[Administrator Name]

Enter the administrator name using alphanumeric characters, hyphens (-), and underscores (_). However, hyphens (-), and underscores (_) cannot be used at the beginning.

[Password]

Enter the administrator password. Use at least two character types from alphanumeric characters, numbers, and symbols.

[Confirm Password]

Enter the same password as above for confirmation.

Authorized User Account

Add authorized users.

[User Name], [Password], [Confirm Password]

To add the authorized user, enter the user name and password, then click [Add].

Enter the user name using alphanumeric characters, hyphens (-), and underscores (_).

Up to 15 authorized users can be added.

For password, use at least two character types from alphanumeric characters, numbers, and symbols.

[User List]

Displays a list of added authorized users.

Able to sort the list items in ascending order by clicking  and in descending order by clicking .

Select a user in the list and click  to remove the registered user.

User Authority

Set the privileges for authorized users and guest users. This setting enables to set access restrictions for the Settings Page.

[Camera Control], [Video Distribution]

Select the items for granting users privileges.

An authorized user has higher privileges than a guest user.

If [Video Distribution] is not selected, the Settings Page is not displayed. To display the Settings Page, enter the user name and password of an account with video distribution privilege in the dialog displayed when the Settings Page is opened or when switching accounts.

Important

However, when connected to the RTP server as an authorized user, it is disabled to restrict guest users' privileges.

[System] > [Security] > [Host Access Restrictions]

Access control can be performed individually by address to access over the network. Set IPv4 and IPv6, respectively.

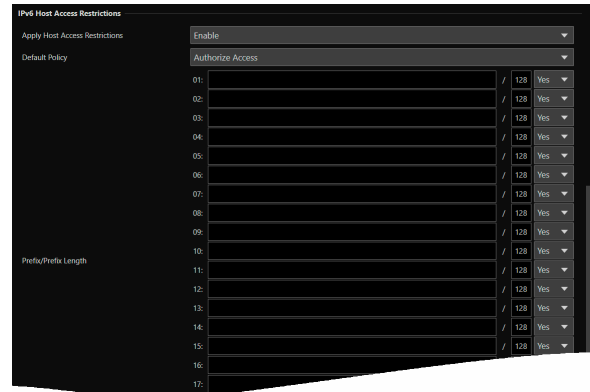
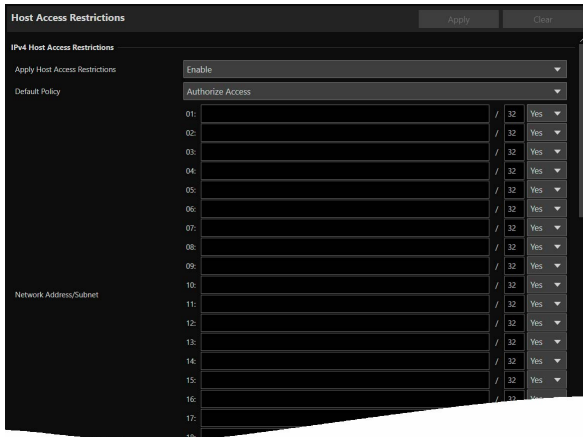

Important

- To prohibit access via a proxy server in HTTP connection, a proxy server address must be set.
- If host access restriction is set mistakenly, access to the Settings Pages themselves may be prohibited, in which case restoring the factory default settings will become the only means of recovery.

Note

If the same address is entered, the setting that is displayed higher on the list will be applied.

IPv4 Host Access Restrictions

Specify the hosts from which IPv4 access is permitted and prohibited. This setting is common to wired and wireless LANs.

[Apply Host Access Restrictions]

Select whether to use IPv4 host access restrictions.

[Default Policy]

Select whether to allow or block access from IPv4 addresses that have not been specified in [Network Address/Subnet].

[Network Address/Subnet]

Enter IPv4 addresses into the list and select [Yes] or [No] for access for each address.

It is possible to specify the subnet to set access restrictions by network or host.

If set to [No], access to all ports is blocked.

IPv6 Host Access Restrictions

Specify the hosts from which IPv6 access is permitted and prohibited.

[Apply Host Access Restrictions]

Select whether to use IPv6 host access restrictions.

[Default Policy]

Select whether to allow or block access from IPv6 addresses that have not been specified in [Prefix/Prefix Length].

[Prefix/Prefix Length]

Enter IPv6 addresses (prefixes) into the list and select [Yes] or [No] for access for each address.

It is possible to specify the prefix length to set access restriction by network or host.

If set to [No], access to all ports is blocked.

[System] > [System] > [Camera]

Camera system settings.

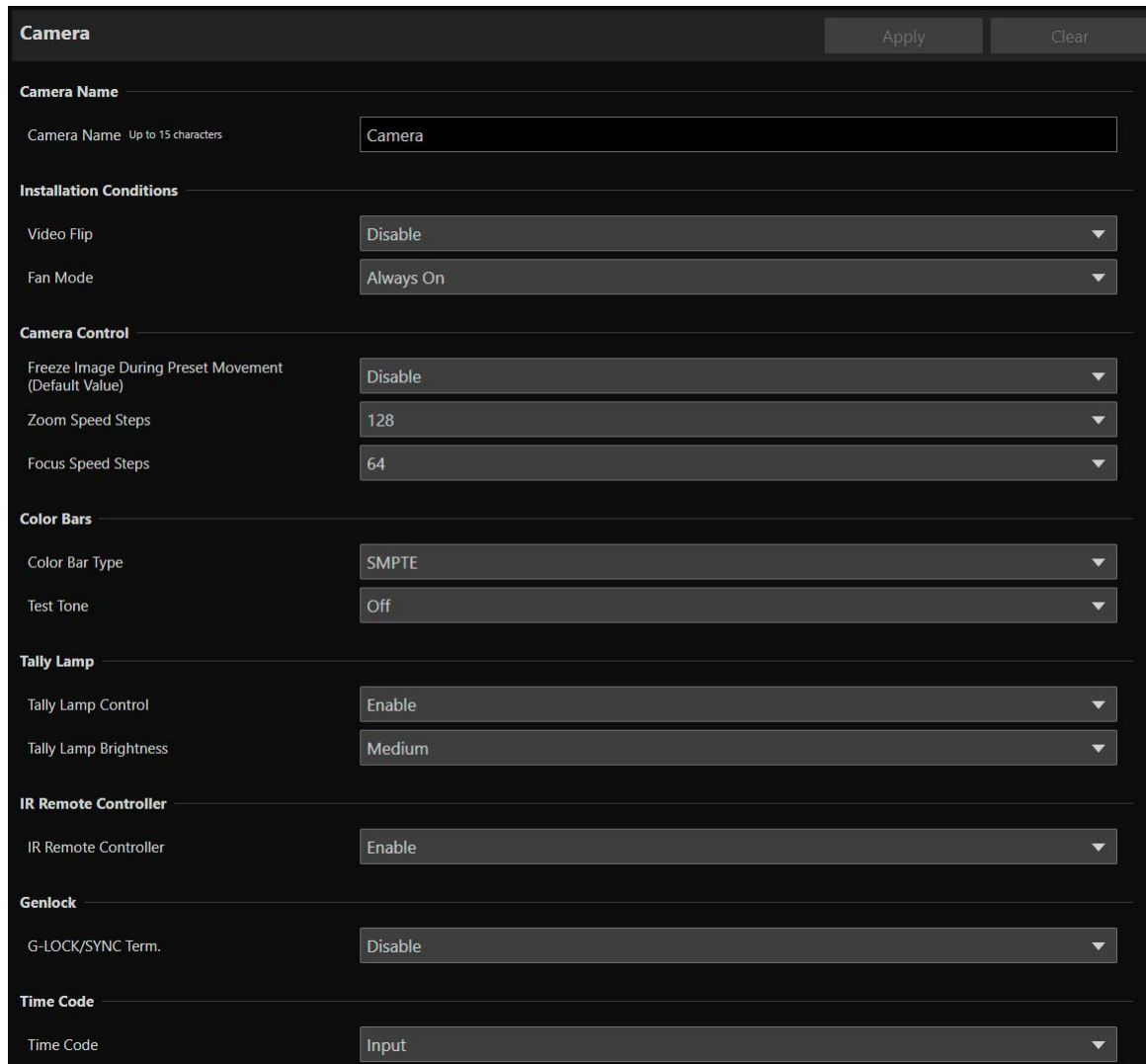

Section	Setting	Value
Camera Name	Camera Name (Up to 15 characters)	Camera
Installation Conditions	Video Flip	Disable
	Fan Mode	Always On
Camera Control	Freeze Image During Preset Movement (Default Value)	Disable
	Zoom Speed Steps	128
	Focus Speed Steps	64
Color Bars	Color Bar Type	SMPTE
	Test Tone	Off
Tally Lamp	Tally Lamp Control	Enable
	Tally Lamp Brightness	Medium
IR Remote Controller	IR Remote Controller	Enable
Genlock	G-LOCK/SYNC Term.	Disable
Time Code	Time Code	Input

Camera Name

Settings for the camera name.

[Camera Name]

Enter any camera name.

Installation Conditions

Settings for camera use suitable for the location the camera will be installed.

[Video Flip]

Select whether to vertically flip the video.

Select the setting suited to the camera installation method, such as ceiling mount or placing on a desk.

[Fan Mode]

You can change the fan's operation mode from the menu.

[Auto]

If the internal temperature of the camera is too high, the fan will be activated automatically. When the camera's temperature has decreased sufficiently, the fan will be turned off.

[Always On]

The fan runs at all times.

Note

- Depending on the ambient temperature and other shooting conditions, the fan may not turn off even if you set its operating mode to [Auto].

Camera Control

Settings related to camera control.

[Freeze Image During Preset Movement (Default Value)]

Sets whether to display a still image by default during preset movement.

[Zoom Speed Steps]

Select the number of zoom control speed steps when operating the zoom function using an external device, such as a controller.

[Focus Speed Steps]

Select the number of focus control speed steps when operating the manual focus function using an external device, such as a controller or via the Settings Page.

Color Bars

Settings for color bars and test tones (audio reference signal).

When outputting color bars, set [Other Functions] > [Color Bars] to [On].

[Color Bar Type]

You can choose from SMPTE, EBU and ARIB color bars.

[Test Tone]

The camera can output a 1 kHz audio reference signal with the color bars. You can select one of the following audio levels: [Off], [-12dB], [-18dB] or [-20dB].

Tally Lamp

Settings for the tally lamp.

[Tally Lamp Control]

Select whether to use tally lamp control.

[Tally Lamp Brightness]

Select the brightness of the tally lamp when [Tally Lamp Control] is set to [Enable].

IR Remote Controller

Settings for the IR remote controller.

[IR Remote Controller]

Select whether to use IR remote controller.

For details on IR remote controller, refer to "Chapter 3 IR Remote Controller" (P. 106).

Genlock

Genlock enables to synchronize the video signal of the camera with the external video device.

Use the GEN-LOCK/SYNC terminal to input external sync signals (analog black burst signal or HD ternary signal) to the camera. After changing the function of the GEN-LOCK/SYNC terminal to [HD Sync Output], you can use the camera's video signal as a reference sync signal (tri-level HD signal) to synchronize an external device to this camera.

[G-LOCK/SYNC Term.]

Select whether to use Genlock. If used, select the GEN-LOCK terminal function.

[Genlock Input]

Select this function when inputting an external reference signal to the camera.

[HD Sync Output]

Select this function when outputting a reference video signal from the camera. The reference signal's configuration is determined by the video output configuration of the 12G-SDI OUT terminal and [SYNC Scan Mode] settings.

[Genlock Adjustment]

Adjusts the H phase of the genlock in the range of approximately ± 0.4 H around the phase difference 0.

[SYNC Scan Mode]

When outputting a reference video signal

Note

- When a synchronizable Genlock signal is inputted, synchronization will stabilize after approximately 10 seconds.
- If an incorrect Genlock signal is inputted, synchronization may not be stable.

Time Code

You can use the camera's TIME CODE terminal to synchronize this camera's time code to an external signal. You can also output the camera's time code signal. From the menu, set the TIME CODE terminal's input/output mode in advance.

[Time Code]

Selects the TIME CODE terminal's input/output mode.

[Input]

Select this setting when inputting an SMPTE-standard LTC timing signal to the TIME CODE terminal. Be sure to set this setting before connecting an external device.

[Output]

The time code signal output from the TIME CODE terminal will be a SMPTE-standard LTC timing signal.

■ About the time code running mode

The time code running mode is fixed to Free Run.

■ About drop or non-drop frame

When the frame rate is set to 59.94P, 59.94i or 29.97P, the time code is fixed to drop frame (DF). When the frame rate is set to an option other than 59.94P, 59.94i or 29.97P, the time code is fixed to non-drop frame (NDF).

The time code display will change depending on the setting. When set to DF, the time code will appear as [00:00:00.00]; when set to NDF, it will appear as [00:00:00:00].

Note

- Use a 24-frame time code signal when the frame rate is set to 23.98P, a 25-frame time code signal when it is set to 25.00P, 50.00i or 50.00P and a 30-frame time code signal for other frame rates.
- When a suitable external time code signal is received, the camera's own time code will be synchronized to it and the synchronization will be maintained even if you disconnect the cable from the TIME CODE terminal.
- When an external time code signal is received, the DF/NDF selection will follow the external time code signal's settings.

- Turning the camera on/off while the cable is not connected will cause the synchronization to be reset. The correct time code will be restored once you reconnect the cable.
- A letter appears next to the time code onscreen display superimposed on the HDMI/SDI output video signal (P. 58) depending on the setting/status.
 - When the time code running mode is Free Run: [F]
 - When the time code signal is coming from an external source: [E]

[System] > [System] > [Add-On]

Perform management such as adding and updating applications and licenses.

The screenshot displays the 'Add-On Management' interface. At the top, there is an 'Add/Update' section with a search bar and an 'Install' button. Below this is the 'Add-On List' section, which contains a table with the following data:

Name	Running
Auto Tracking Application RA-AT001	Running

A 'Delete' button is located below the table. To the right of the table, a bracket labeled 'Application list' spans the 'Add-On List' and 'Delete' button areas. Below the table, the 'Free Space' is shown as 20184 KB (19.7 MB) and the 'Locking Code' is displayed as a series of asterisks. A bracket labeled 'Information about the selected application' spans the entire bottom section of the interface. A callout box labeled '(1)' points to the application name 'Auto Tracking Application RA-AT001' in the list. The detailed settings for this application include: Vendor (Canon Inc.), Start Up/Stop (Running/Stop), Version (1.1.0), License (with an 'Import' button), Enable: Trial License (- 2023/11/03), Add-On Top Page (with an 'Open' button), Automatic Startup (On), Log (with 'View' and 'Download' buttons), Back Up Settings (with an 'Execute' button), Restore Settings (with an 'Execute' button), Encryption Password (0,8 to 32 characters), and Restore Default: Settings (with an 'Execute' button).

Add-On Management

Displays a list of the installed applications. In addition, you can also add and delete applications.

[Add/Update]

Click [...], specify the application to add/update, and click [Install].

[Add-On List]

Displays a list of applications and their status.

[Delete]

Select the application you want to delete, then click [Delete].
When a confirmation message is displayed, click [OK].

[Free Space]

Displays the free Add-On space. This allows you to estimate the space for applications that can be installed.

[Locking Code]

Displays the camera locking code (camera unique information). This is used when registering a license.

Information About the Selected Application

Information about the selected application* is displayed and you can perform tasks such as updating a license.

* The name of the currently selected application is displayed in (1).

[Vendor]

Displays the name of the application vendor.

[Start Up/Stop]

Displays the status of the application. The application can be controlled by clicking [Start Up] or [Stop]. You can run up to four applications at the same time.

[Version]

Displays the version of the application.

[License]

- Import: Click [...], specify a license file, and click [Import].
- Status: If [Disable] or [Not Registered] is displayed, check the license term or registration status again.
- Term: Displays the license term.
- Delete: Click [Delete] to delete the license file.

[Add-On Top Page]

When [Open] is clicked, [Add-On Top Page] is displayed, where you can configure the application settings. It can also be displayed by clicking [Camera Control 1] > [Other Functions] > [Add-On] (P. 49).

[Automatic Startup]

Select whether to automatically start up the application when the camera starts up. Up to four applications can be set.

[Log]

When [View] is clicked, the log messages for the application are displayed. When [Download] is clicked, the message list can be downloaded as a file.

[Back Up Settings]

Back up the settings of the selected application.

[Restore Settings]

Restore settings from the backup file created with [Back Up Settings].

Depending on the application, there may be functions that operate by referring to the camera settings. In that case, the camera's setting values must also be restored (P. 102).

[Encryption Password]

You can set a password to use when backing up and restoring settings. The password is used to encrypt the backup data itself. Use at least two character types from single-byte alphabetic characters, numbers, and symbols.

When restoring from encrypted backup data, enter the password set during the backup.

[Restore Default Settings]

Initializes the setting values of the selected application.



Note

- Even if a firmware update is performed for the camera and applications, the license is inherited.
- If [License status has changed. Please restart the Add-On.] is displayed, click [Stop] to stop the application, and then click [Start Up] to restart it.

Auto Tracking Application (Lite)

By using the Auto Tracking Application (Lite) installed with this firmware, you can automatically track and shoot subjects. In the Auto Tracking Application (Lite), some functions are unavailable or their settings cannot be changed*. For details on the functions and available operations, refer to the Auto Tracking Application User Manual.

All features are available when you purchase and activate a license for the Auto Tracking Application.

* In the application's settings screen,  is displayed on setting items.

[System] > [System] > [Date and Time]

Settings for camera date and time.

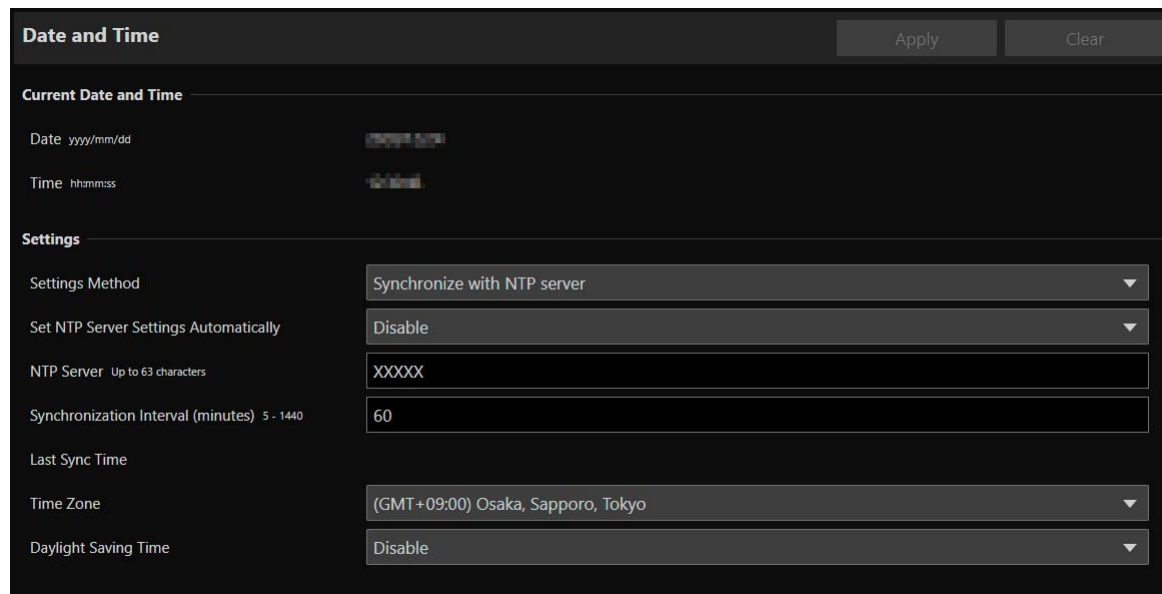

Date and Time		Apply	Clear
Current Date and Time			
Date	yyyy/mm/dd		
Time	hh:mm:ss		
Settings			
Settings Method	Synchronize with NTP server		
Set NTP Server Settings Automatically	Disable		
NTP Server	XXXXX		
Synchronization Interval (minutes)	60		
Last Sync Time			
Time Zone	(GMT+09:00) Osaka, Sapporo, Tokyo		
Daylight Saving Time	Disable		

Current Date and Time

The date and time set in the camera are displayed.

Settings

It is possible to change the date and time setting method, time zone and daylight saving time set at initial setting.

[Settings Method]

Select the date and time setting method.

[Set manually]

Set the desired date and time in [Date] and [Time].

Set the time in 24-hour format in <hour:minute:second> order.

[Synchronize with NTP server]

Synchronize with the time of NTP server specified in the displayed [Set NTP Server Settings Automatically].

[Set NTP Server Settings Automatically]

Select one of the following setting methods:

[Disable]

Enter the IP address or host name of the NTP server in [NTP Server].

[Use DHCP]

The camera's time is synchronized with the time of the NTP server at the address acquired from the DHCP server.

The acquired NTP server address is displayed in [NTP Server (DHCP)].

In order to set this, change [System] > [Communication] > [Network] > [IPv4] > [IPv4 Address Settings Method] to [Auto (DHCP)] (P. 75).

[Use DHCPv6]

The camera's time is synchronized with the time of the NTP server at the address acquired from the DHCPv6 server. The acquired NTP server address is displayed in [NTP Server (DHCPv6)].

In order to set this, change [System] > [Communication] > [Network] > [IPv6] > [IPv6] to [Enable], then set [Auto (DHCPv6)] to [Enable] (P. 76).

[Use DHCP/DHCPv6]

The camera's time is synchronized with the time of the NTP server at the address acquired from the DHCP server or DHCPv6 server.

If the NTP server address can be acquired from both the DHCP server (IPv4) and DHCPv6 server, the NTP server address acquired from the DHCP server (IPv4) will be used.

[Synchronization Interval (minutes)]

Enter the query interval for the specified NTP server.

[Last Sync Time]

The time last synchronized with the specified NTP server will be displayed.

[Synchronize with computer time]

The date and time will be synchronized with that of the computer currently accessing the camera. After clicking [Apply], [Settings Method] will change to [Set manually].

[Time Zone] is not automatically selected, so set it if necessary.

**Note**

If the NTP server IP address is incorrect or a connection with the NTP server cannot otherwise be established, [Last Sync Time] will not be updated, or will be left blank.

[Time Zone]

Select the appropriate GMT (Greenwich Mean Time) time difference.

When the time zone is changed and [Apply] is selected, the date and time will be automatically changed based on the selected time zone.

[Daylight Saving Time]

Select whether to automatically adjust for daylight saving time to suit the time zone.

[System] > [System] > [Environment]

Settings for the frame frequency and maximum resolution.

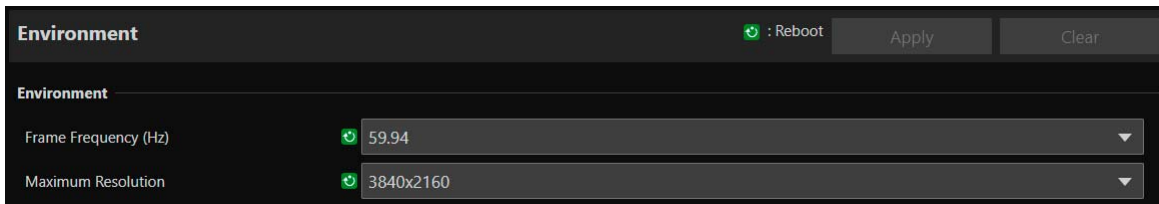

Environment

Sets the frame frequency and maximum resolution. The HDMI/SDI output signal format and the frame rate of the IP streaming video are selected according to the frame frequency and maximum resolution.

[Frame Frequency (Hz)]

Frame frequency can be changed by the initial settings. Options for [Exposure] > [Shutter Mode] > [Slow (sec.)] also will be changed, so check the settings of presets if they were registered.

[Maximum Resolution]

Maximum resolution can be changed by the initial settings. When using the advanced zoom or crop functions, be sure to use a compatible maximum resolution setting (P. 45, P. 50).

[System] > [Maintenance] > [General]

Check camera information such as the firmware version, and perform maintenance on the camera system.

General Reboot

Device Information

Model Name CR-N700

Firmware Version

Serial Number

Build Number

MAC Address (Wired LAN)

MAC Address (Wireless LAN)

Tool

See Third Party Software License Conditions View

Pan/Tilt Initialization Execute

Reboot Execute

Initialization

Network Settings and Management Information Save

Restore Default Settings Execute

Device Information

[Model Name], [Firmware Version], [Serial Number], [Build Number], [MAC Address (Wired LAN)], [MAC Address (Wireless LAN)]

Displays information about the camera.

Tool

Displays license, initialization of the Pan/Tilt settings, and rebooting the camera.

[See Third Party Software License Conditions]

Third party software license information is displayed as a list.

[Pan/Tilt Initialization]

If the Pan/Tilt position shifts, click [Execute] to initialize the position.

[Reboot]

Reboots the camera.

Initialization

Initialize the camera.



Important

- Do not turn off the power to the camera while performing [Restore Default Settings]. Turning off the camera at this stage may result in disabling its ability to boot correctly.
- Once [OK] is clicked, the process of restoring the default settings cannot be interrupted.

[Network Settings and Management Information]

When set to [Save], initialization will be performed except for the following settings.

- Network Settings
- NTP Server
- HTTP Server
- Host Access Restrictions
- Time Zone
- Certificates
- SSL/TLS
- Administrator Name
- Administrator Password

When set to [Do not save], initialization will be performed all the settings excluding camera's date and time, Add-On applications, and licenses.

Since the network settings will be initialized, connection to the camera will not be enabled. Use the Camera Search Tool to configure the initial settings.



Note

Even if the [Network Settings and Management Information] is set to [Save], the [Wireless LAN] setting will be initialized.

[Restore Default Settings]

After rebooting, follow the selection in [Network Settings and Management Information] to restore the default settings.



Note

- Before clicking [Execute] in [Restore Default Settings], it is recommended to back up the current settings.
- It is possible to restore the factory default settings by using the RESET switch, but be aware that all the settings except the camera date and time will be restored to the factory default settings (P. 124).

[System] > [Maintenance] > [Backup/Restore]

Save/restore camera settings.

Backup/Restore Reboot

Backup

Encryption Password 0.8 to 32 characters

Back Up Settings Execute

Restore

Restore Target All Settings

Encryption Password 0.8 to 32 characters

Restore Settings Execute

Important

Do not turn off the power to the camera while performing [Back Up Settings] or [Restore Settings]. Turning off the camera at this stage may result in disabling its ability to boot correctly.

Backup

Settings related to backup.

[Encryption Password]

Able to set a password to use when backing up and restoring. This is the password for encrypting the backup data itself. When restoring from encrypted backup data, enter the password set when backing up. Use at least two types of single-byte alphanumeric characters, numbers, or symbols.

[Back Up Settings]

All settings except date and time will be backed up. The administrator account and certificates used in SSL/TLS, including private key will also be backed up.

Note

The settings are not restored if the password set when backing up and the password set when restoring do not match.

Restore

Settings related to restoring.

[Restore Target], [Restore Settings]

Selects the target settings to be restored, from the backup file created with [Back Up Settings].

If [Other than Network Settings and Management Information] is selected, settings other than network settings, administrator information, registered user information, time zone, certificates, and access restrictions are restored. After restoring, the camera will be rebooted.

Important

- Be aware that if restored from a backup file of another camera, problems such as duplicate addresses on the network or overwriting with a different Administrator Password may cause problems such as being unable to connect to the camera.
- When restoring the settings, do not use a backup file created with a firmware version newer than that of the camera to restore.

Note

When restoring settings, even protected custom picture files in the camera will be replaced.

[Encryption Password]
Same as for [Backup].

[System] > [Maintenance] > [Update Firmware]

Perform firmware update.

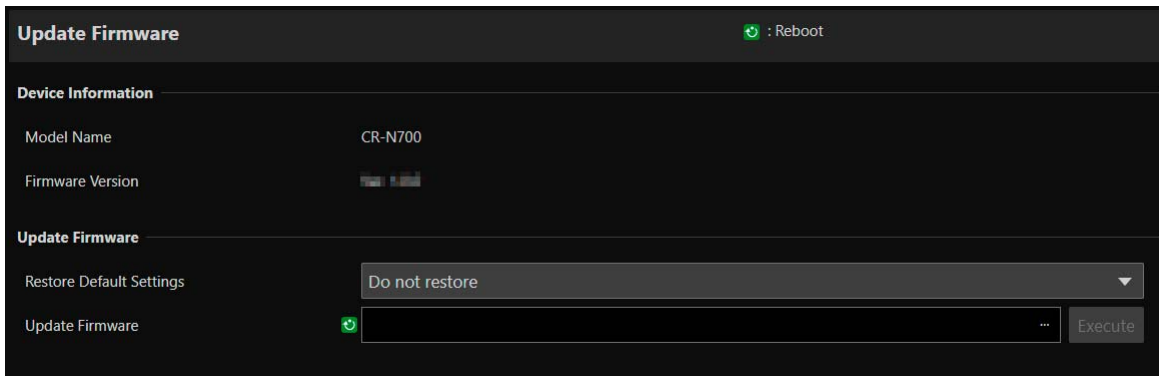

Update Firmware Reboot

Device Information

Model Name: CR-N700

Firmware Version: 1.0.0

Update Firmware

Restore Default Settings: Do not restore

Update Firmware Execute

Device Information

[Model Name], [Firmware Version]
Camera information is displayed.

Update Firmware

Performs firmware update.



Important

Do not turn off the power to the camera while performing [Update Firmware]. Turning off the camera at this stage may result in disabling its ability to boot correctly.

[Restore Default Settings]

Updating the firmware restores to the default settings.

If set to [Restore], everything is restored except the following settings.

- Network Settings
- NTP Server
- HTTP Server
- Host Access Restrictions
- Time Zone
- Certificates
- SSL/TLS
- Administrator Name
- Administrator Password
- Add-On applications and licenses



Note

- Even if the [Restore Default Settings] is set to [Do not restore], the [Wireless LAN], [Custom Picture] and [User LUT] settings will be restored.
- You can back up/restore settings using [System] > [Maintenance] > [Backup/Restore] on the Settings Page (P. 102).

[Update Firmware]

Click [...] to select the firmware file for updating and click [Execute]. When a confirmation message is displayed, click [OK] to start Update Firmware. During update, the camera's front STATUS lamp will blink.

After update firmware is performed, the camera will be rebooted.

[System] > [Maintenance] > [Log]

Display and download log messages.

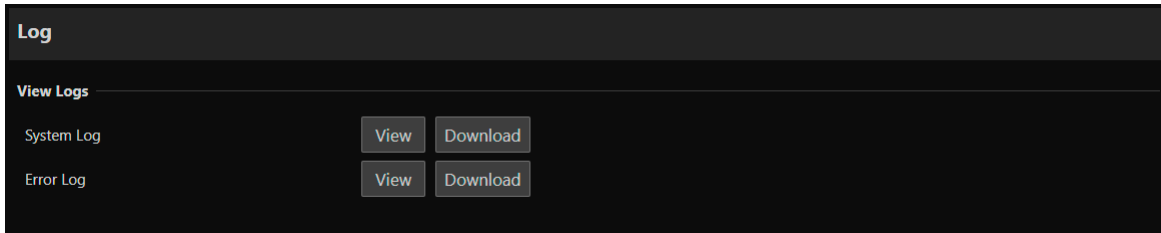

View Logs

Displays the history of camera operation and connection.

[System Log], [Error Log]

When [View] is clicked, log messages from the time the camera was turned on is displayed.

When [Download] is clicked, the message list can be downloaded as a file.

For details on log message, refer to "List of Log Messages" (P. 113).

Chapter 3

IR Remote Controller

This chapter explains the features and handling of the included IR remote controller.

Names and Functions of Parts

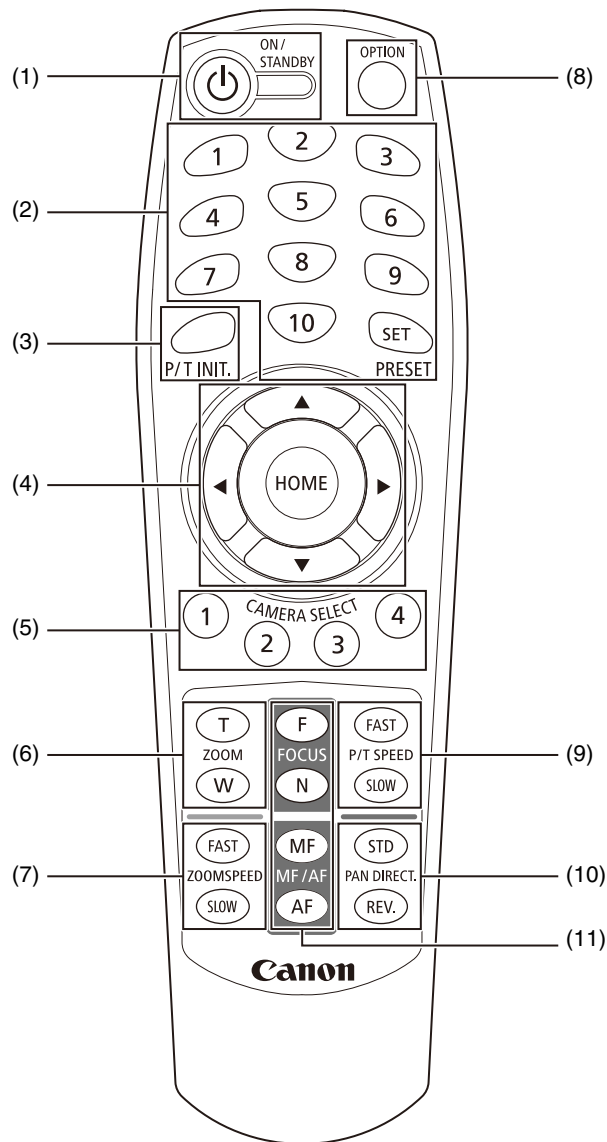

(1) ON/STANDBY button

Use the button to switch between the camera on and standby mode. Set it to standby if required to stop HDMI/SDI output or IP distribution of videos.

When the camera receives the remote controller's signal, the POWER lamp on the front of the camera blinks twice (green).

The POWER lamp lights up (orange) when the camera is in standby, and blinks (green) when the camera is returning to standby.

(2) PRESET

Set or call a preset.

If a number (1 to 10) is pressed while pressing the SET button, the current camera settings such as camera angle, zoom and focus are saved as a preset to that number. Press the number (1 to 10) to call the registered preset.

Note

- Registrable presets are 1 to 10. Presets unable to register are 11 to 100.
- If any preset is registered to 1 to 10, the new setting is overwritten.
- When calling a preset with the IR Remote Controller, the preset is called at the speed set in advance in P/T SPEED.
- Presets from the IR remote controller are unable to be deleted.

•The image at the time of preset registration is saved as a thumbnail.

(3) **P/T INIT. button**

If the pan/tilt position is shifted, press the P/T INIT. button to initialize the position.

(4) **▲, ▼, ◀, ▶, HOME button**

Press ▲ or ▼ button to change the camera angle in the tilt direction, or press ◀ or ▶ button to change the camera angle in the pan direction.

Press the HOME button to return the camera angle to the home position (P. 47).

(5) **CAMERA SELECT**

Press the number of the camera wanting to operate with the IR remote controller.

Use the SERVICE switch on the back of the camera to set the camera number.

 **Note**

If there is a camera set to the same camera number nearby, the IR remote controller may operate the cameras simultaneously. It is recommended to use a different camera number for cameras installed nearby.

For details on setting the camera number, refer to "Installation Guide/Important Information".

(6) **ZOOM**

Press the T button to zoom in (telephoto), and the W button to zoom out (wide angle).

(7) **ZOOMSPEED**

Adjusts the zoom speed.

Press the FAST button to increase the operating speed or the SLOW button to decrease it.

(8) **OPTION button**

Not supported (for future expansion).

(9) **P/T SPEED**

Adjusts the pan/tilt speed.

Press the FAST button to increase the operating speed or the SLOW button to decrease it.

(10) **PAN DIRECT.**

Press the REV. button to reverse the panning direction.

Press the STD button to return to the original direction.

(11) **FOCUS, MF/AF**

Use for focusing.

Press the AF button to adjust the focus automatically. To adjust the focus manually, press the MF button, then the F (FAR) button and the N (NEAR) button to adjust.

Handling the Remote Controller

■ Battery Replacement

Remove the battery cover on the back of the remote controller, and insert two new AAA batteries by paying attention to the + positive and - negative directions. Close the battery cover tightly until it snaps.

■ Precautions

- If the remote controller does not work, replace the battery with a new one.
- Do not drop or damage the remote controller.
- Avoid getting liquid on the remote controller. This may cause the remote controller to malfunction.

Chapter 4

Appendix

This chapter explains the measures to take when trouble occurs or a log message is displayed during camera use.

It also explains how to reset the camera to the factory default settings, perform routine maintenance, major specifications and camera security measures.

Troubleshooting

Before contacting the dealer from where the product was purchased or Canon Customer Service Center, check the following items. If a log message is displayed, check the details of the message and the corresponding countermeasures in the log message list.

Note

A problem caused by the security software may occur. Configure to exclude the camera, or the software where the problem occurred, in the security software.

Problem	Countermeasures
The camera does not launch.	<ul style="list-style-type: none"> • If a PoE++ hub is being used, check if the LAN cable is connected correctly. • If an external DC power supply is being used, check if the cable that connects the camera to the power supply is connected correctly. If properly connected, but the camera still does not launch, check if the power required to start the camera system (12 V DC) is being supplied correctly. • Turn the camera off and restart (Refer to "Installation Guide/Important Information"). • Some PoE++ supported hubs limit the power used per port or the total power consumed by each port. If the limit is exceeded, it may not start, so check the instructions of PoE++ supported hub for use.
Settings Page is not displayed.	<ul style="list-style-type: none"> • Check if the LAN cable is connected correctly. • Check if the network to which the camera is connected is set up correctly. In particular, check if the IP address, subnet mask and default gateway address are set within the ranges supported by the applicable network. • If the IP address was changed, the new address will not become effective until the camera is rebooted. • Check if the correct URI (camera IP address) is entered in the web browser. • Check whether the connection is from a computer whose access is blocked in [System] > [Security] > [Host Access Restrictions] (P. 90). • Configure to exclude the camera, or the software where the problem occurred, in the security software.
Unable to connect to the camera in wireless LAN.	<ul style="list-style-type: none"> • Exceeds the maximum number of devices that can be connected to the camera via wireless LAN. Disconnect the wireless LAN connection of the devices that do not use the camera. • There is a possibility that the signal is bad or there is signal interference by electronic equipment around the camera. Refer to "Cautions and Troubleshooting for Wireless LAN Connection" (P. 19) and respond accordingly. • Reset the camera (P. 100) and start from the initial settings again (P. 14).
Unable to operate the camera from the IR remote controller.	<ul style="list-style-type: none"> • Go to [System] > [System] > [Camera], and select [Enable] for [IR Remote Controller] (P. 92). • Check the IR remote controller's CAMERA SELECT number and the setting of the SERVICE switch on the rear of the camera.
The camera cannot be operated from the IR remote controller that supports Standard Communication (Serial).	<ul style="list-style-type: none"> • RS-422 connection is not working correctly. Check the connection to the RS-422 terminal and the wiring of the RS-422 cable. • The remote controller and the setting of serial connection on the Settings Page are different. Select [System] > [Communication] > [External Connection (Serial)], check [Serial Device Address], and set the camera number to the same as that of the remote controller. Also set Baud Rate (9600 bps or 38400 bps) to the same setting.
There is no audio during IP distribution.	<ul style="list-style-type: none"> • If there is no audio, check the settings in [System] > [Video and Audio] > [Audio] as well as the sound and audio device settings for the computer. • Audio cannot be heard on the Settings Page.
The ND filter indicator (P. 58) superimposed on the HDMI/SDI output video signal appears in red or as [- -].	<ul style="list-style-type: none"> • The ND filter mechanism may not be working properly. Contact a Canon Customer Service Center.
Pan/tilt does not operate as intended.	<ul style="list-style-type: none"> • Check if the pan/tilt movement range is limited in [System] > [Video and Audio] > [Movement Range].
There is no video or audio on the external monitor during HDMI/SDI output.	<ul style="list-style-type: none"> • The camera is not properly connected to an external monitor. Check the cable connections, reseal the cable, or turn the camera off and restart. • Set the external monitor according to the output signal of the camera. • Replace the cable.

Problem	Countermeasures
Peaking and markers are not displayed on the external monitor. LUT/View Assistance is not applied on the screen.	<ul style="list-style-type: none"> Check the settings to see that the desired function is enabled on the desired monitor/video output. Onscreen displays output has not been enabled. Activate the output of the camera's onscreen displays (P. 57).
There is no audio.	<ul style="list-style-type: none"> Set [System] > [Video and Audio] > [Audio] > [General Audio] > [Audio Input Mode] correctly, depending on the microphone connected. If an external microphone requires phantom power for the INPUT terminal, set [System] > [Video and Audio] > [Audio] > [General Audio] > [Audio Input Mode] to [INPUT Terminal/MIC+48V].
The sound is distorted or reduced.	<ul style="list-style-type: none"> Shooting near loud sounds (fireworks, concerts, etc.) may distort or make the sound smaller than it actually is. In [System] > [Video and Audio] > [Audio] > [General Audio] > [Input Volume], adjust the volume of the input audio.
Forgot the administrator password.	<ul style="list-style-type: none"> It is possible to initialize all settings of the camera excluding date and time using the RESET switch (P. 124). After performing initialization, use the Camera Search Tool to register the administrator account again. The IP address and subnet mask, etc. also need to be set again because the network settings are initialized.
The tally lamp does not light.	<ul style="list-style-type: none"> In [System] > [System] > [Camera], set [Tally Lamp Control] to [Enable].
The STATUS lamp on the front of the camera is blinking.	<ul style="list-style-type: none"> The firmware of the camera is being updated. It may take a while. The pan/tilt position is shifted. Executing [Pan/Tilt Initialization] in [System] > [Maintenance] > [General] > [Tool] initializes the pan/tilt position. If using an IR remote controller, press the P/T INIT button to initialize. If the POWER lamp is also blinking, there may be some abnormality occurred to the camera. Restart the camera. If the problem is still not solved, contact the sales representative.
Out of focus.	<ul style="list-style-type: none"> When autofocus is used to control the focus, some subjects may be difficult to focus on automatically. If this happens, adjust the focus manually. When [AF Mode] is set to [AF-Boosted MF], start focusing manually until you approach the in-focus position. If the lens is dirty, please clean it. For details, refer to "Cleaning the Lens" (P. 131).
Subject appears bent diagonally.	<ul style="list-style-type: none"> When shooting a fast-moving subject with the camera or when the angle of view changes during shooting, the subject may appear to be bent diagonally. This is a phenomenon that occurs when a CMOS image sensor is used, and is not a camera malfunction.
The image rotates in the opposite direction to the camera operation.	<ul style="list-style-type: none"> Make sure [System] > [System] > [Camera] > [Installation Conditions] is set to [Video Flip] correctly (P. 91). If connecting to a remote controller, the setting of the controller may be reverse. For details, refer to the instruction manual of controller.
Files cannot be saved.	<ul style="list-style-type: none"> Operation System prohibits saving to certain folders. Accordingly, an attempt to save a file may fail. Specify [Documents], [Pictures] and other folders.

■ POWER/STATUS Lamp

POWER lamp	STATUS lamp	Status
Green light BLINKING	OFF	Initializing (Starting and restarting)
Green light ON	OFF	POWER ON
Green light BLINKING (twice)	OFF	Signal received from IR remote controller
Orange light ON	Orange light ON	Standby
Green light BLINKING	OFF	Changing to or from standby
OFF	Orange light ON	Insufficient power
OFF	Orange light BLINKING	Pan/Tilt position error, firmware being updated
Green light BLINKING	Orange light BLINKING	Device failure, fan error

List of Log Messages

Log Messages on the Camera

The list of log messages displayed in [System] > [Maintenance] > [Log] > [View Logs] on the Settings Page (P. 105). Log messages are classified into the following types.

Category	Level	Code	Fault level
crit	Error	4xx	Software-level failure (Task operations will stop)
err	Error	3xx	Operational error (Operations will continue)
warning	Warning	2xx	Non-operational error
notice	Warning	1xx	Error external to the system
info	Information	0xx	Information on normal operation



Note

If no content is recorded in a log for approximately two hours, "-- MARK --" will be recorded in the message area.

Error Log

System Error

S303 Error on saving settings [err]

Description	Can't update files of system settings (S303)
Meaning	An error generated while the system was saving a setting, Can't update system settings.
Countermeasure	If the error is detected after rebooting, initialize to the factory default settings. If the problem persists, contact the dealer.

S320 PAN/TILT operation error [err]

Description	%1 error occurred. [%2] (S320)
%1	PAN TILT
%2	Error details
Meaning	An error occurred during operation or stopping of PAN/TILT.
Countermeasure	Check if there is anything that interferes with the PAN/TILT operation, such as the contact of the camera head with something. After resolving, execute [Pan/Tilt Initialization] (P. 100). If it is still not resolved, it may be a camera failure, so contact the dealer.

S330 Broken Fan [err]

Description	FAN does not rotate. (S330)
Meaning	The fan does not rotate or a significant decrease in speed is detected.
Countermeasure	If the error is still detected after rebooting, it may be a fan failure, so contact the dealer.

S332 Fan Operation has failed [err]

Description	Cannot control FAN. (S332)
Meaning	IO is not available to control the fan.
Countermeasure	If the error is still detected after rebooting, it may be a fan failure, so contact the dealer.

S350 Error in resuming from or switching to standby [err]

Description	Failed to resume from standby or switch to standby (S350)
Meaning	Failed to resume from or switch to the standby status.
Countermeasure	If the error is still detected after rebooting, contact the dealer.

S360 Audio Video synchronize error [err]

Description	Audio Video synchronize error. (S360)
Meaning	Video/Audio synchronize error
Countermeasure	If the error is still detected after rebooting, it may be a failure, so contact the dealer.

S430 Temperature sensor failure [crit]

Description	cannot get temperature (S430)
Meaning	Cannot get the temperature from the temperature sensor.
Countermeasure	If the error is still detected after rebooting, it may be a failure of the board, so contact the dealer.

S370 Thumbnail creation error [err]

Description	Can't create thumbnail (S370)
Meaning	There was an error when creating a thumbnail. Thumbnail cannot be saved.
Countermeasure	If still detected after restarting, it is necessary to initialize to factory settings, or contacting the dealer.

■ Audio server error

B301 Audio device error [err]

Description	cannot use audio device for %1 [%2:%3] (B301)
%1	Send/Receive type (rx tx)
%2	Error type (open write flush)
%3	Error number
Meaning	Detected an error in the audio device.
Countermeasure	If the error is still not cleared, contact the dealer.

B402 Audio server initialization failed [err]

Description	wvaudio initialization error [%1] (B402)
%1	Error number
Meaning	The audio server could not be initialized. The audio server stops.
Countermeasure	If the error is still detected after rebooting, it may be a failure, so contact the dealer.

B403 Settings change failed [err]

Description	cannot set config [%1:%2] (B403)
%1	Error notification number
%2	Error number
Meaning	The settings could not be updated. The audio server stops.
Countermeasure	If the error is still detected after rebooting, it may be a failure, so contact the dealer.

■ Video error

V400 Video input initialization error [crit]

Description	video %1 initialization failure - %2 (%3) (V400)
%1	Video number
%2	Procedure details
%3	Error details
Meaning	The video input function was stopped because the video input system could not be initialized.
Countermeasure	If the error is still detected after rebooting, it may be a failure, so contact the dealer.

V401 Video input command error [crit]

Description	video command error - %1 (V401)
%1	Procedure details
Meaning	The video input function was stopped because a video input command could not be processed. Or, it may not operate in the desired setting.
Countermeasure	If the error is still detected after rebooting, it may be a failure, so contact the dealer.

V402 Video input frozen [crit]

Description	video %1 stalled (V402)
%1	Video number
Meaning	The video input function was stopped because the video input from the camera stopped.
Countermeasure	If the error is still detected after rebooting, it may be a failure, so contact the dealer.

V403 Internal error in intelligent service [err]

Description	cannot work intelligent (%1)(%2)(%3). (V403)
%1	Error number
%2	Reason for error
%3	Error information
Meaning	An internal error occurred in intelligent service.
Countermeasure	If the error is still detected after rebooting, it may be a failure, so contact the dealer.

V404 Intelligent service startup error [crit]

Description	intelligent initialization error (%1)(%2). (V404)
%1	Error number
%2	Reason for error
Meaning	A startup error occurred in intelligent service.
Countermeasure	If the error is still detected after rebooting, it may be a failure, so contact the dealer.

V405 Internal error in intelligent service [crit]

Description	intelligent working error (%1)(%2). (V405)
%1	Error number
%2	Reason for error
Meaning	An internal error occurred in intelligent service.
Countermeasure	If the error is still detected after rebooting, it may be a failure, so contact the dealer.

■ Standard communication (IP) error

D401 Standard communication (IP) initialization failed [crit]

Description	Standard Com initialization error[%1] (D401)
%1	Error number
Meaning	Standard communication (IP) could not be initialized.
Countermeasure	If the error is still detected after rebooting, it may be a failure, so contact the dealer.

■ RTP error

R401 RTP initialization failed [crit]

Description	RTP initialization error[%1] (R401)
%1	Error number
Meaning	RTP could not be initialized.
Countermeasure	If the error is still detected after rebooting, it may be a failure, so contact the dealer.

■ NDI|HX error

P401 NDI|HX initialization failed [crit]

Description	NDI HX initialization error[%1] (P401)
%1	Error number
Meaning	NDI HX could not be initialized.
Countermeasure	If the error is still detected after rebooting, it may be a failure, so contact the dealer.

■ SRT error

T401 SRT initialization failed [crit]

Description	SRT initialization error [%1] (T401)
%1	Error number
Meaning	SRT could not be initialized.
Countermeasure	If the error is still detected after rebooting, it may be a failure, so contact the dealer.

■ Output Tracking Data error

F301 Output Tracking Data startup error [err]

Description	free-d initialization error [%1] (F301)
%1	Error number
Meaning	Output Tracking Data startup failed.
Countermeasure	If the error is still detected after rebooting, it may be a failure, so contact the dealer.

■ Add-On error

A381 License date/time inconsistency detection error [err]

Description	Date/Time inconsistency was detected. (A381)
Meaning	License date/time inconsistency was detected.
Countermeasure	Contact the dealer because the license may be locked.

Warning log

■ Audio server warning

B203 Audio message send failure [warning]

Description	audio message send error %1 [%2] (B203)
%1	Message type
%2	Error number
Meaning	Failed to send audio message.

B204 Audio message receive error [warning]

Description	audio message rcv error [%1:%2] (B204)
%1	Error notification number
%2	Reason for error
Meaning	Failed to receive audio message.

■ Camera application warning

C211 Camera control command overflow [warning]

Description	command queue overflowed (C211)
Meaning	The camera control command queue overflowed, and some commands were discarded.
Countermeasure	Send the camera control command again after a while.

C222 Recall preset during the color bars output [warning]

Description	Can't run preset, because color bars is on. (C222)
Meaning	Preset was recalled during the color bars output.
Countermeasure	Turn off the color bars output and recall the preset again.

C232 Trace execution during the color bars output [warning]

Description	Can't run trace, because color bars is on. (C232)
Meaning	Tracing was executed during the color bars output.
Countermeasure	Turn off color bars output and try tracing again.

C241 Invalid Look File data error [warning]

Description	Illegal input Lookfile data format (C241)
Meaning	There is invalid data in the registered Look File.
Countermeasure	Check the Look File format.

C242 Look File data analysis error [warning]

Description	Illegal Lookfile analysis result (C242)
Meaning	Invalid result in the registered Look File data analysis.
Countermeasure	Check if there is an abnormal value in the Look File.

C243 Look File checksum error [warning]

Description	lookfile checksum error (C243)
Meaning	There is a checksum error in the registered Look File.
Countermeasure	Check if the backup file is correct.

C244 Look File hash mismatch error [warning]

Description	lookfile hash mismatch error %1[%2] (C244)
%1	CP User LUT
%2	Number
Meaning	There is a hash mismatch in the registered Look File.
Countermeasure	Register the Look File again according to the target and number.

■ RTP warning

R101 RTSP authentication failure [notice]

Description	RTSP Error: error_code=401: Unauthorized (R101)
Meaning	RTSP authentication failed.

R102 RTSP connection failure [notice]

Description	RTSP Error: error_code=%d: (R102)
%d	400: When an invalid RTSP request is received etc. 503: The maximum number of RTP connections has been exceeded, or a request for multiple session streaming with tunneling for the same stream has been received, etc.
Meaning	RTSP connection has failed.

R103 RTP session disconnected [notice]

Description	session closed: num_of_sessions=%1 (R103)
%1	Total number of client sessions
Meaning	The session was disconnected from the client due to a factor other than TEARDOWN. (For example, TCP FIN)

R104 RTP session deleted [notice]

Description	session removed: num_of_sessions=%1 (R104)
%1	Total number of client sessions
Meaning	The session was deleted due to errors. (Session Timeout or when an invalid RTSP request is received)

■ Add-On warning

A111 Notice for application to be installed [notice]

Description	Incorrect Add-On installation package. (A111)
Meaning	The installation or update was canceled because an invalid application package was detected.
Countermeasure	Install the correct application.

A112 Camera firmware and application version inconsistency notice [notice]

Description	Mismatched Add-On framework version. (A112)
Meaning	The installation or update was canceled due to an ineligible version of the application.
Countermeasure	Verify the camera firmware and application version.

A113 Notice for application to be installed [notice]

Description	Add-On package version is older than current version. (A113)
Meaning	The update was canceled because the version of the application package is out of date.
Countermeasure	Install the latest application. To downgrade the currently installed application, first uninstall the application and then install the required version of the application. Please note that the application settings and license file will be deleted at that time.

A114 Application uninstallation notice [notice]

Description	Add-On application (%1) not stopped. (A114)
%1	Application name
Meaning	Update or uninstall canceled because the application is running.
Countermeasure	Close the application.

A115 Notice of application not supporting camera [notice]

Description	Mismatched platform. (A115)
Meaning	The installation or update was canceled because the application is not compatible with the device.

A116 Notice of application not supporting camera [notice]

Description	Add-On application does not support this device. (A116)
Meaning	The installation or update was canceled because the application is not compatible with the device.
Countermeasure	Contact the dealer and ask whether there is another way.

A117 Notice of free space in application area being insufficient [notice]

Description	No space left on device. (A117)
Meaning	The installation or update was canceled due to insufficient storage capacity.
Countermeasure	Delete an installed application with low priority.

A120 Application license file installation notice [notice]

Description	Add-On application (%1) not installed. (A120)
%1	Application name
Meaning	The license installation was canceled because the application is not installed.
Countermeasure	Check the combination of the application and the license file.

A121 Application license file notice [notice]

Description	Add-On license file (%1) incorrect. (A121)
%1	Application name
Meaning	The license installation or update was canceled because an invalid license was detected.
Countermeasure	Install the correct license file.

A122 Application license overwriting error [notice]

Description	Add-On license overwrite error. (A122)
Meaning	The update was canceled because a license combination that does not allow for updates was uploaded.

A125 Application license file uninstallation notice [notice]

Description	Add-On license (%1) not installed. (A125)
%1	Application name
Meaning	The license uninstallation was canceled because the license is not installed.
Countermeasure	Specify the correct license file.

A126 Password mismatch when restoring application settings [notice]

Description	Add-On config file password mismatch. (A126)
Meaning	The restoring process was canceled because the password for [Back Up Settings] and [Restore Settings] does not match.

A127 Application uninstallation error [notice]

Description	Add-On application (%1) can not be uninstalled. (A127)
%1	Application name
Meaning	The operation was canceled because the application cannot be uninstalled.
Countermeasure	Check the application to be uninstalled. Pre-installed applications cannot be deleted.

A171 Number of applications registrable automatically exceeded [notice]

Description	Number of Add-On applications to register exceeded limit. (A171)
Meaning	Automatic startup registration was suspended because the upper limit for applications registrable for automatic startup was exceeded.
Countermeasure	Cancel the registration of one of the already registered automatic startup applications and then configure the automatic startup setting for the desired application again.

A181 Application pre-installation failure [notice]

Description	Add-On application pre-install operation timed out. (A181)
Meaning	Timeout for the application preinstallation process.
Countermeasure	Uninstall low-priority applications and reboot the camera.

■ SRT warning

T201 SRT connection failure [warning]

Description	SRT connection error: %1 (T201)
%1	caller connection: Connection error (in Caller mode)
Meaning	SRT connection has failed.

■ Output Tracking Data warning

F201 Output Tracking Data transmission failure [warning]

Description	free-d message output error IP: %1 (F201)
%1	Destination IP address
Meaning	Tracking data transmission failed.

■ Video warning

V201 Intelligent service message receiving failure [warning]

Description	intelligent message rcv error %1 (%2). (V201)
%1	Error number
%2	Reason for error
Meaning	Failed to receive intelligent service message.

Notification log

■ System notification

S001 System started [info]

Description	starting paramd (S001)
Meaning	Parameter management module started.

S002 System settings changed [info]

Description	Updated system settings. (S002)
Meaning	Settings not requiring rebooting were changed.

S020 Thumbnail creation module start/stop [info]

Description	%1 thumbnaild (S020)
%1	starting stopping
Meaning	Thumbnail creation module started/ stopped.

S070 Change to certificate [info]

Description	%1: succeeded to %2 certificate (S070)
%1	ssl
%2	generate import delete export
Meaning	A certificate was created/imported/ deleted/exported

S080 The power required to start the camera system is not supplied [info]

Description	Insufficient power to boot the camera system. (S080)
Meaning	The power required to start the camera system is not being supplied.
Countermeasure	Use a DC or PoE++ supported L2 switch as the power source.

S046 Connect a device through a wireless LAN [info]

Description	Connected : %1 (S046)
%1	MAC address of the connected device
Meaning	Device successfully connected.

S047 Disconnect a device connected through a wireless LAN [info]

Description	Disconnected: %1 (S047)
%1	MAC address of the connected device
Meaning	Disconnected from the device.

S043 Wireless LAN Interface Enabled [info]

Description	wireless interface enabled (S043)
Meaning	The wireless LAN interface is enabled.

S045 Wireless LAN Interface Disabled [info]

Description	wireless LAN interface disabled (S045)
Meaning	The wireless LAN interface has been disabled.

S050 IPv4 address assigned to wired LAN interface [info]

Description	IPv4 Address %1 %2 was assigned to the wired I/F (S050)
%1	Set IPv4 address
%2	"from router" for DHCPv4 address
Meaning	IPv4 address is set for wired LAN.

S051 IPv6 address assigned to wired LAN interface [info]

Description	IPv6 Address %1 %2 was assigned to the wired I/F (S051)
%1	Set IPv6 address
%2	"from router" for DHCPv6/RA address
Meaning	IPv6 address is set for wired LAN.

S052 IPv4 address assigned to wireless LAN interface [info]

Description	IPv4 Address %1 was assigned to the wireless I/F (S052)
%1	Assigned IPv4 address
Meaning	IPv4 address is assigned to wireless LAN.

S054 IPv4 address for wired LAN interface is released [info]

Description	IPv4 Address %1 %2 was released from the wired I/F (S054)
%1	Released IPv4 address
%2	"from router" for DHCPv4 address
Meaning	IPv4 address assigned to wired LAN is released.

S055 IPv6 address for wired LAN interface is released [info]

Description	IPv6 Address %1 %2 was released from the wired I/F (S055)
%1	Released IPv6 address
%2	"from router" for DHCPv6/RA address
Meaning	IPv6 address assigned to wired LAN is released.

S056 IPv4 address for wireless LAN interface is released [info]

Description	IPv4 Address %s was released to the wireless I/F (S056)
%1	Released IPv4 address
Meaning	IPv4 address assigned to wireless LAN is released.

S140 Wired LAN and wireless LAN interface on the same subnet [notice]

Description	same subnet ethernet interface and wireless LAN interface (S140)
Meaning	The wired and wireless LANs are configured on the same subnet.

S351 Cannot communicate with imaging module [err]

Description	Cannot communicate with IMC (S351)
Meaning	Communication with the imaging module failed.
Countermeasure	If the error is still detected after rebooting, contact the dealer.

S352 Cannot communicate with imaging module [err]

Description	Data corruption detected in communications with IMC (S352)
Meaning	The contents of communication with the imaging module are invalid.
Countermeasure	If the error is still detected after rebooting, contact the dealer.

S353 Cannot communicate with imaging module [err]

Description	Communication timeout with IMC (S353)
Meaning	Communication with the imaging module timed out.
Countermeasure	If the error is still detected after rebooting, contact the dealer.

■ HTTP Server Notification

H001 System started/stopped [info]

Description	%1 httpd (H001)
%1	starting stopping
Meaning	HTTP Server started/stopped.

H145 Authentication failure [notice]

Description	Authentication failed for %1, IP: %2 (H145)
%1	Implemented countermeasures against URL XSS vulnerability (Equivalent to ftpd)
%2	IP address
Meaning	Authentication failed.

■ wvhttp notification

W001 System started/stopped [info]

Description	%1 wvhttp (W001)
%1	starting stopping
Meaning	wvhttp server started/stopped.

W030 Startup and shutdown of wvhttp Client [info]

Description	%1%2 host=<Host>, user=<User>, prio=<Priority>(W030)
%1	W (wvhttp session V (Session-less video client) N (Session-less event client)
%2	+ : Connect, - : Disconnect
Meaning	The camera server client was connected or disconnected.

W031 Transmitted video data size [info]

Description	%1 = host=<Host>, user=<User>, video=<Number of frames> (W031)
%1	W (wvhttp session V (Session-less video client)
Meaning	When a client disconnected, the total data that was sent to the client is displayed in number of frames.

W103 Authentication failure [notice]

Description	Authentication failed, IP: <IP address> (W103)
Meaning	Authentication failed.

■ Audio server notification

B001 Audio server started/stopped [info]

Description	%1 audio. (B001)
%1	starting stopping
Meaning	The audio server started/stopped.

B101 Received unusual request [notice]

Description	%1 unusual request[%2] (B101)
%1	Client host IP address
%2	Unusual type (400 404)
Meaning	Refused the request due to command error (400) and parameter error (404).

■ Camera application notification

C001 Camera control module started/stopped [info]

Description	%1 camerad (C001)
%1	starting stopping
Meaning	The camera control module started/stopped.

C002 Camera application started/stopped [info]

Description	starting cameraappl (C002)
Meaning	The camera application started.

■ Video notification

V001 Video server started/stopped [info]

Description	%1 video (V001)
%1	starting stopping
Meaning	The video server started/stopped.

V002 Intelligent service started/stopped [info]

Description	%1 intelligent. (V002)
%1	starting stopping
Meaning	The intelligent service started/stopped.

■ Standard communication (IP) notification

D001 Standard communication (IP) notification started/stopped [info]

Description	%1 Standard Com (D001)
%1	starting stopping
Meaning	The standard communication (IP) started/stopped.

■ RTP notification

R001 RTP started/stopped [info]

Description	%1 RTP (R001)
%1	starting stopping
Meaning	The RTP started/stopped.

R002 RTSP PLAY request received [info]

Description	PLAY received: client_IP=%1, num_of_sessions=%2 (R002)
%1	Client IP address <ul style="list-style-type: none"> Displays "HTTP tunneling connection" if the streaming protocol is HTTP tunneling.
%2	Total number of client sessions
Meaning	RTSP PLAY request was received.

R003 RTSP TEARDOWN request received [info]

Description	TEARDOWN received: client_IP=%1, num_of_sessions=%2 (R003)
%1	Client IP address <ul style="list-style-type: none"> Displays "HTTP tunneling connection" if the streaming protocol is HTTP tunneling.
%2	Total number of client sessions
Meaning	RTSP TEARDOWN request was received.

■ NDI|HX notification

P001 Starting and stopping of NDI|HX [info]

Description	%1 NDI HX (P001)
%1	starting stopping
Meaning	The NDI HX started/stopped.

■ RTMP notification

P011 rtmpcd started/stopped [info]

Description	%1 rtmpcd (P011)
%1	starting stopping
Meaning	rtmpcd has started/stopped.

P012 RTMP stream start [info]

Description	RTMP start: %1 (P012)
%1	success error
Meaning	Starting of RTMP stream succeeded/failed.

P013 RTMP stream stopped [info]

Description	RTMP stop: %1 (P013)
%1	normal setting disconnected
Meaning	RTMP stream stopped due to normal processing/change of settings/disconnection.

■ SRT notification

T001 SRT started/stopped [info]

Description	%1 SRT (T001)
%1	starting stopping
Meaning	The SRT started/stopped.

T002 SRT delivery start [info]

Description	start SRT stream: IP=%1 (T002)
%1	Destination IP address
Meaning	SRT delivery started.

T003 SRT delivery stop [info]

Description	stop SRT stream: IP=%1 (T003)
%1	Destination IP address
Meaning	SRT delivery stopped.

■ Output Tracking Data notice

F001 Output Tracking Data function start and stop [info]

Description	%1 free-d (F001)
%1	starting stopping
Meaning	Output Tracking Data function started/stopped.

F002 Tracking data transmission start and stop [info]

Description	%1 free-d message output IP: %2 (F002)
%1	start stop
%2	Destination IP address
Meaning	Tracking data transmission started/ stopped.

■ Add-On notification

A001 Application installation and uninstallation [info]

Description	Add-On application %1 (%2). (A001)
%1	Install Uninstall
%2	Application ID
Meaning	An application was installed/updated/ uninstalled.

A002 License installation and uninstallation [info]

Description	Add-On license %1 (%2). (A002)
%1	Install Uninstall
%2	Application ID
Meaning	A license was installed/updated/ uninstalled.

Restoring to the Factory Default Settings

If the settings have been forgotten and want to set the camera from the beginning, restore the factory default settings first. It is recommended to use [System] > [Maintenance] > [Backup/Restore] on the Settings Page to create a backup file before restoring the factory default settings (P. 102).

Important

If restored to the factory default settings, the camera will be unable to connect because the administrator account is also initialized. Use the Camera Search Tool to configure the initial settings.

Note

For the factory default settings, refer to P. 126.

Restoring to the Initial Settings from a Web Browser

Use [System] > [Maintenance] > [General] > [Initialization] > [Network Settings and Management Information] > [Do not save] on the Settings Page (P. 100).

Restoring to the Factory Default Settings with the RESET Switch on the Camera

If the IP address or the Administrator password on the camera is forgotten, operating the camera via the network is not possible. In this case, press the RESET switch to reset the camera.

1 Turn the camera off.

The camera does not have a power switch. In order to turn the camera on or off, connect or disconnect the power supply cable.

2 Turn on the power while pushing the RESET switch, confirm that the POWER lamp lights up (green), and then release the RESET switch after about five seconds.

The RESET switch is located in a recessed area. Push the switch using the tip of a pointed object such as a clip. When the POWER lamp stops blinking (green), the reset procedure is complete.

Note

The Add-On applications and licenses will not be deleted (application setting values are initialized). If you want to delete them*, press down the 3rd SERVICE switch from the left and then perform the operation of step 2. When the reset completes, turn off the power and return the switch to its original position.

* The Auto Tracking Application (Lite) reverts to the version that was previously installed at the time of purchase or firmware update.

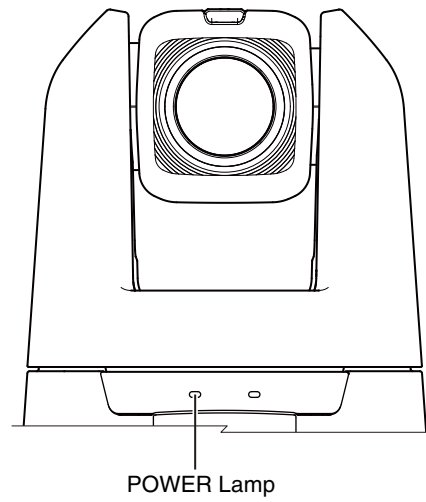
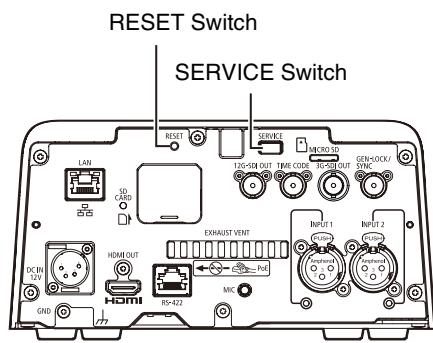

List of Factory Default Settings

Item	Factory Default Settings
• Exposure	
Shooting Mode	Full Auto
ND Filter	Off
Infrared Shooting (IR)	Off
ISO/Gain	Gain
High Sensitivity Mode	Off
Shockless Gain	Off
Iris Limit	On
Slow Shutter for IR Shooting	Off
Iris Increment	1/4 stop
Fine Increment	Off
Shutter Increment	1/4 stop
Gain Increment	Normal
Flicker Reduction	Off
Diffraction correction	Off
• WB	
Shockless WB	Off
Color Temperature Increment	Mired
• Focus	
Focus Mode	AF
AF Mode	Continuous
AF Frame Size	Whole Area
Face AF	Face Det. & Tracking
Face Detection AE	Off
Eye Detection	Off
AF Speed	Normal
AF Response	Normal
Focus Limit	Off
• Custom Picture	
CP File	C1: BT.709 Normal
 (Lock)	Lock
Gamma/Color Space	BT.709 Normal / BT.709
Color Matrix	Video
Look Files	–
HLG Color	Vivid
Edit	Black: Master Pedestal 0
	Black: Master Black Red 0

Item	Factory Default Settings
Black: Master Black Green	0
Black: Master Black Blue	0
Black Gamma: Level	0
Black Gamma: Range	0
Black Gamma: Point	0
Knee: Activate	On
Knee: Automatic	On
Knee: Slope	0
Knee: Point	95
Knee: Saturation	0
Low Key Saturation: Activate	Off
Low Key Saturation: Level	0
Sharpness: Level	0
Sharpness: Detail Frequency	0
Sharpness: Coring Level	0
Sharpness: Limit	0
Noise Reduction	Auto
Noise Reduction: Spatial Filter	0
Noise Reduction: Frame Correlation	0
Skin Detail: Effect Level	Off
Skin Detail: Assist	Off
Skin Detail: Hue	0
Skin Detail: Chroma	16
Skin Detail: Area	16
Skin Detail: Y Level	16
White Balance: R Gain	0
White Balance: G Gain	0
White Balance: B Gain	0

Item	Factory Default Settings
Over 100%	Through
Color Matrix Tuning: Gain	0
Color Matrix Tuning: Phase	0
Color Matrix Tuning: R-G	0
Color Matrix Tuning: R-B	0
Color Matrix Tuning: G-R	0
Color Matrix Tuning: G-B	0
Color Matrix Tuning: B-R	0
Color Matrix Tuning: B-G	0
Color Correction: Select Area	Off
Color Correction: Assist	Off
Area A: Setting Phase	0
Area A: Setting Chroma	16
Area A: Setting Area	16
Area A: Setting Y Level	16
Area A: Revision Level	0
Area A: Revision Phase	0
Area B: Setting Phase	0
Area B: Setting Chroma	16
Area B: Setting Area	16
Area B: Setting Y Level	16
Area B: Revision Level	0
Area B: Revision Phase	0
• PTZ/IS	
Digital Zoom	Off
Pan/Tilt Acceleration	Medium
Image Stabilizer	Standard
• Preset	
Speed Specification	On

Item	Factory Default Settings
Speed Mode	Time
Time (sec.)	2 seconds
Freeze Image During Movement	Off
• Other Functions	
Color Bars	Off
• Crop	
Output: 12G-SDI	Full Screen
Output: HDMI/3G-SDI	Full Screen
Touch Operation Target	On
Crop 1	On
Crop 2	On
• Monitoring	
LUT: 12G-SDI	Off
View Assist: HDMI/3G-SDI	Off
Range (Canon Log): 12G-SDI	Full Range
Range (HDR): 12G-SDI	Narrow Range
Range (Canon Log): HDMI/3G-SDI	Full Range Priority
Range (HDR): HDMI/3G-SDI	Narrow Range
• OSD	
OSD Output: 12G-SDI	Off
OSD Output: HDMI/3G-SDI	Off
Peripheral Border	Off
• Assistance	
Peaking: 12G-SDI	Off
Peaking: HDMI/3G-SDI	Off
Peaking	Peaking 1
Peaking Details	White
Peaking 1: Color	8
Peaking 1: Gain	2
Peaking 1: Frequency	2
Peaking 2: Color	Red
Peaking 2: Gain	15
Peaking 2: Frequency	1
Markers: 12G-SDI	Off
Markers: HDMI/3G-SDI	Off
Center Marker	Off
Center Marker Type	Cross 1
Horizontal Marker	Off
Vertical Marker	Off

Item	Factory Default Settings
Grid Marker	Off
Aspect Marker	Off
Marker Aspect Ratio	4:3
Marker Custom Aspect Ratio	2.56:1
Safe Area Marker	Off
Basis for Marker Safe Area	Whole Picture
Marker Safe Area %	95.00% (Side Length)

System

Item	Factory Default Settings
<ul style="list-style-type: none"> HDMI/SDI Shared 	
12G-SDI	3840x2160/59.94P
HDMI/3G-SDI	1920x1080/59.94P
<ul style="list-style-type: none"> Crop 	
Crop 1	1920x1080
Crop 2	1920x1080
Output: 12G-SDI	Full Screen
Output: HDMI/3G-SDI	Full Screen Crop 1 Crop 2
<ul style="list-style-type: none"> SDI 	
12G-SDI Mapping	Level A
3G-SDI Mapping	Level A
Time Code Output	Enable
<ul style="list-style-type: none"> Mainstream 	
Video Codec	H.264
Video Size	1920x1080
Framerate (fps)	59.94
Bit Rate Control	VBR
Target Bit Rate (Mbps)	20
I Frame Interval (sec.)	1.0
<ul style="list-style-type: none"> Substream 1 	
Video Codec	H.264
Video Size	640x360
Framerate (fps)	29.97
Bit Rate Control	VBR
Target Bit Rate (Mbps)	6
I Frame Interval (sec.)	1.0
<ul style="list-style-type: none"> Substream 2 	
Video Codec	JPEG
Video Size	1280x720
Framerate (fps)	14.99

Item	Factory Default Settings
<ul style="list-style-type: none"> General Audio 	
Audio Input	Enable
Audio Input Mode	MIC Terminal/LINE
Input Volume	50
<ul style="list-style-type: none"> IP Audio Streaming 	
Distribution Bit Rate (kbps)	128
<ul style="list-style-type: none"> Pan/Tilt 	
Movement Limit	Disable
<ul style="list-style-type: none"> HTTP Server 	
Authentication Method	Digest Authentication
HTTP Port	80
HTTPS Port	443
<ul style="list-style-type: none"> Video Server 	
Maximum Number of Clients	15
Maximum Connection Time (sec.)	0
<ul style="list-style-type: none"> RTP Server 	
RTP	Disable
RTSP Authentication Method	Digest Authentication
RTSP Port	554
<ul style="list-style-type: none"> Audio Settings 	
Audio Compression Method	AAC-LC 48kHz
Multicast Address	0.0.0.0
Multicast Port	0
Multicast TTL	1
<ul style="list-style-type: none"> RTP Mainstream 	
Video Type	H.264 1920x1080
Multicast Address	0.0.0.0
Multicast Port	0
Multicast TTL	1
Audio Transmission	Enable
<ul style="list-style-type: none"> RTP Substream 1 	
Video Type	H.264 640x360
Multicast Address	0.0.0.0
Multicast Port	0
Multicast TTL	1
Audio Transmission	Enable
<ul style="list-style-type: none"> RTP Substream 2 	
Video Type	JPEG 1280x720
Multicast Address	0.0.0.0
Multicast Port	0
Multicast TTL	1

Item	Factory Default Settings
Audio Transmission	Enable
• LAN	
Maximum Packet Size	1500
• IPv4	
IPv4 Address Settings Method	Auto (DHCP)
AutoIP	Enable
IPv4 Address (AutoIP)	–
• IPv6	
IPv6	Enable
Auto (RA)	Enable
Auto (DHCPv6)	Enable
IPv6 Address (Manual)	(Blank)
Prefix Length	64
IPv6 Default Gateway Address	(Blank)
IPv6 Address (Auto)	–
• DNS	
Name Server Address 1	(Blank)
Name Server Address 2	(Blank)
Set Name Server Address Automatically	Use DHCP/DHCPv6
Host Name	(Blank)
Search Domain	(Blank)
Search Domain List	(Blank)
• mDNS	
mDNS	Enable
• Interface	
Wireless LAN	Disable
• Standard Communication (IP)	
Standard Communication (IP)	Enable
Response Port Number	Specified Port Number (52381)
Camera IP Settings Inquiry	Allow
Camera IP Settings Network Settings	Do Not Allow
• ND H HX	
ND H HX	Disable
• RTMP	
RTMP	Disable
• Output Tracking Data	
Output Tracking Data	Disable
• SRT	
SRT	Disable

Item	Factory Default Settings
• Serial Port	
Serial Port	Enable
Serial Port Connection Type	RS422
Baud Rate (bps)	9600
Data Length (bit)	8
Start Bit (bit)	1
Stop Bit (bit)	1
Parity	Not Supported
• Standard Communication (Serial)	
Standard Communication (Serial)	Enable
Serial Device Address	Auto
• Server Certificate Management	
Server Certificate	(Blank)
Server Certificate Password	(Blank)
Server Certificate List	(Blank)
• Create Certificate	
Country (C)	(Blank)
State/Province (ST)	(Blank)
Locality (L)	(Blank)
Organization (O)	(Blank)
Organizational Unit (OU)	(Blank)
Common Name (CN)	(Blank)
Validity Period Start Date	(Blank)
Validity Period End Date	(Blank)
• Encrypted Communications	
HTTPS Connection Policy	HTTP and HTTPS
• Server Certificate	
Server Certificate	(Blank)
• Administrator Account	
Administrator Name	(Blank)
Password	(Blank)
Confirm Password	(Blank)
• Authorized User Account	
User Name	(Blank)
Password	(Blank)
Confirm Password	(Blank)
User List	(Blank)
• User Authority	
Authorized User	Camera Control <input checked="" type="checkbox"/>
	Video Distribution <input checked="" type="checkbox"/>
Guest User	Camera Control <input checked="" type="checkbox"/>
	Video Distribution <input checked="" type="checkbox"/>

Item	Factory Default Settings
<ul style="list-style-type: none"> IPv4 Host Access Restrictions Apply Host Access Restrictions 	Disable
<ul style="list-style-type: none"> IPv6 Host Access Restrictions Apply Host Access Restrictions 	Disable
<ul style="list-style-type: none"> Camera Name Camera Name 	Camera
<ul style="list-style-type: none"> Installation Conditions Video Flip 	Disable
<ul style="list-style-type: none"> Fan Mode 	Always On
<ul style="list-style-type: none"> Camera Control Freeze Image During Preset Movement (Default Value) 	Disable
<ul style="list-style-type: none"> Zoom Speed Steps 	128
<ul style="list-style-type: none"> Focus Speed Steps 	64
<ul style="list-style-type: none"> Color Bars Color Bar Type 	SMPTE
<ul style="list-style-type: none"> Test Tone 	Off
<ul style="list-style-type: none"> Tally Lamp Tally Lamp Control 	Enable
<ul style="list-style-type: none"> Tally Lamp Brightness 	Medium
<ul style="list-style-type: none"> IR Remote Controller IR Remote Controller 	Enable
<ul style="list-style-type: none"> Genlock G-LOCK/SYNC Term. 	Disable
<ul style="list-style-type: none"> Genlock Adjustment 	0
<ul style="list-style-type: none"> SYNC Scan Mode 	P
<ul style="list-style-type: none"> Time Code 	Input
<ul style="list-style-type: none"> Add-On Management Add/Update 	(Blank)
<ul style="list-style-type: none"> Add-On List 	Auto Tracking Application RA-AT001
<ul style="list-style-type: none"> Auto Tracking Application RA-AT001 Start Up/Stop 	Stop
<ul style="list-style-type: none"> License 	(Blank)
<ul style="list-style-type: none"> Automatic Startup 	Off
<ul style="list-style-type: none"> Restore Settings 	(Blank)
<ul style="list-style-type: none"> Encryption Password 	(Blank)
<ul style="list-style-type: none"> Current Date and Time 	
<ul style="list-style-type: none"> Settings Settings Method 	Set manually
<ul style="list-style-type: none"> Time Zone 	(GMT+09:00) Osaka, Sapporo, Tokyo
<ul style="list-style-type: none"> Daylight Saving Time 	Disable

Item	Factory Default Settings
<ul style="list-style-type: none"> Environment Frame Frequency (Hz) 	59.94
<ul style="list-style-type: none"> Maximum Resolution 	3840x2160
<ul style="list-style-type: none"> Initialization Network Settings and Management Information 	Save
<ul style="list-style-type: none"> Backup/Restore Encryption Password 	(Blank)
<ul style="list-style-type: none"> Restore Target 	All Settings
<ul style="list-style-type: none"> Encryption Password 	(Blank)
<ul style="list-style-type: none"> Restore Settings 	(Blank)
<ul style="list-style-type: none"> Update Firmware Restore Default Settings 	Do not restore

Routine Maintenance

Before any maintenance, turn off the power.

Cleaning the External Surface

- 1 Wet a soft cloth with water or a mild detergent and lightly wipe off any dirt.
- 2 Wipe with a dry cloth.

Cleaning the Lens

Remove any dust or dirt particles using a non-aerosol type blower. Use a clean, soft lens-cleaning cloth to gently wipe the lens.

- Scratches on the lens surface may result in poor video capture.
- Autofocus functionality may be degraded if the lens surface is dusty or dirty.

Specifications

For the latest information on this product (firmware and software, user manuals, operating environment, etc.), refer to the Canon website.

CR-N700 Main Unit

■ Camera

Image Sensor	Type 1.0 (1.0 in.) single-plate CMOS sensor Total pixels: approx. 13.40 megapixels Effective pixels: approx. 8.29 megapixels (3840 x 2160)
Lens	f=8.3 – 124.5 mm, F/2.8 – 4.5, 15x optical zoom, 9-bladed iris diaphragm 35mm equivalent focal length: approx. 25.5 (W) – 382.5 mm (T)
Digital Zoom	20x
Lens Configuration	18 elements in 14 groups (including 2 aspheric elements)
Minimum Focusing Distance	1 cm (0.39 in.) at full wide angle, 60 cm (2.0 ft.) throughout the zoom range
Angle of View	Horizontal: 73.0° (W) – 5.7° (T) Vertical: 45.2° (W) – 3.2° (T)
Shutter Speed	1/3 – 1/2000 sec. (specific values depend on the frame frequency) Automatic, speed (1/3-stop increments, 1/4-stop increments), slow, clear scan, angle, off
Iris	Manual (1/3-stop increments, 1/4-stop increments, fine adjustment available), automatic aperture
ISO Speed/Gain	ISO speed: 200 – 12800 Gain: -6.0 dB – 21.0 dB
ND Filter	Built-in (Off, 1/4, 1/16, 1/64), motor operated
White Balance	Auto (AWB), Set A, Set B, preset settings (daylight: 5600 K*, tungsten lamp: 3200 K*), color temperature setting (2000 K – 15000 K), Manual * Color temperatures are given for reference purposes only. Color temperature and color compensation (CC) adjustment available for all settings except custom white balance and AWB.
Focus	Focus mode: Manual, AF-boosted MF, Continuous AF, Face AF, Tracking AF type: Dual Pixel CMOS AF, Contrast AF
Gamma	[Canon Log 3], [PQ], [HLG], [BT.709 Wide DR], [BT.709 Normal], [BT.709 Standard]
Image Stabilizer	Optical-shift image stabilizer (Standard, Powered IS)
Min. Subject Illumination	59.94 Hz: Approx. 3 lux (shutter speed: 1/60, 59.94P) 50.00 Hz: Approx. 2.5 lux (shutter speed: 1/50, 50.00P) – Gain set to 21 dB, [High Sensitivity Mode] set to [On]
Sensor Sensitivity	59.94 Hz: F12 (at 59.94P) 50.00 Hz: F13 (at 50.00P) – 2000 lux, 89.9% reflection, [High Sensitivity Mode] set to [On]
Pan and Tilt	Pan operation range: Horizontal ±170° Pan operation speed: 0.1° – 100°/sec. Tilt operation range: Vertical -30° – +90° Tilt operation speed: 0.1° – 100°/sec.
Infrared Shooting	Available

Server

Video Output Format	12G-SDI	<p>3840x2160: 59.94P, 50.00P, 25.00P, 29.97P, 23.98P 1920x1080: 59.94P, 59.94i/29.97PsF, 50.00P, 50.00i/25.00PsF, 25.00P, 29.97P, 23.98P 1280x720: 59.94P, 50.00P 720x480*1 : 59.94i 720x576*2 : 50.00i *1 Frame Frequency: 59.94 Hz *2 Frame Frequency: 50.00 Hz</p> <p>– Color sampling: 4:2:2, 10 bit</p>
Video Output Format	HDMI/3G-SDI	<p>3840x2160*1 : 59.94P, 50.00P, 25.00P, 29.97P, 23.98P 1920x1080: 59.94P/59.94i, 50.00P/50.00i, 25.00P, 29.97P, 23.98P 1280x720: 59.94P, 50.00P 720x480*1*2 : 59.94P 720x576*1*3 : 50.00P *1 HDMI only *2 Frame Frequency: 59.94 Hz *3 Frame Frequency: 50.00 Hz</p> <p>– Color sampling: 4:2:2, 10 bit – Same video format required for HDMI and 3G-SDI (cannot select different formats for 3G-SDI and HDMI) – When 3840x2160 or 720x480 (720x576) is selected, video will not be outputted to 3G-SDI.</p>
Video Output Format	IP	<p>Frame Frequency: 59.94 Hz 3840x2160: 59.94 fps*, 29.97 fps, 14.99 fps, 5.00 fps 1920x1080: 59.94 fps, 29.97 fps, 14.99 fps, 5.00 fps 1280x720: 59.94 fps, 29.97 fps, 14.99 fps, 5.00 fps 640x360: 59.94 fps, 29.97 fps, 14.99 fps, 5.00 fps Frame Frequency 29.97 Hz 3840x2160: 29.97 fps, 14.99 fps, 5.00 fps 1920x1080: 29.97 fps, 14.99 fps, 5.00 fps 1280x720: 29.97 fps, 14.99 fps, 5.00 fps 640x360: 29.97 fps, 14.99 fps, 5.00 fps Frame Frequency: 50.00 Hz 3840x2160: 50.00 fps*, 25.00 fps, 12.50 fps, 5.00 fps 1920x1080: 50.00 fps, 25.00 fps, 12.50 fps, 5.00 fps 1280x720: 50.00 fps, 25.00 fps, 12.50 fps, 5.00 fps 640x360: 50.00 fps, 25.00 fps, 12.50 fps, 5.00 fps Frame Frequency: 25.00 Hz 3840x2160: 25.00 fps, 12.50 fps, 5.00 fps 1920x1080: 25.00 fps, 12.50 fps, 5.00 fps 1280x720: 25.00 fps, 12.50 fps, 5.00 fps 640x360: 25.00 fps, 12.50 fps, 5.00 fps Frame Frequency: 23.98 Hz 3840x2160: 23.98 fps, 11.99 fps, 5.99 fps 1920x1080: 23.98 fps, 11.99 fps, 5.99 fps 1280x720: 23.98 fps, 11.99 fps, 5.99 fps 640x360: 23.98 fps, 11.99 fps, 5.99 fps * H.265 only</p> <p>– Color sampling: 4:2:0, 8 bit – Depending on the selected frame frequency, JPEG is fixed to one pattern (fixed format, cannot be selected) Resolution: 1280x720 59.94/29.97 Hz: 14.99 fps 50.00/25.00 Hz: 12.50 fps 23.98 Hz: 11.99 fps</p>
Protocol	XC (Canon's original), RTSP/RTP, NDI HX, RTMP/RTMPS, Standard Communication (Serial), Standard Communication (IP), SRT, free-d	
Preset	Number of presets: Max. 100 (including home position)	

■ Interface

Communication Control	LAN, Wi-Fi, Serial, IR
Network Terminal	LAN x 1, RJ45, 1000Base-T
12G-SDI OUT Terminal 3G-SDI OUT Terminal	BNC jack (output only) x 1, 0.8 Vp-p/75 Ω, unbalanced Video SD (SMPTE ST 259) HD (SMPTE 292) 3G (SMPTE 424, 425) 6G (SMPTE ST 2081) 12G (SMPTE ST 2082) Audio SD (SMPTE ST 272) Other than SD (SMPTE ST 299) Embedded audio, Time code (VITC/LTC) Assistance displays can be output (onscreen displays, peaking)
GEN-LOCK/SYNC terminal	BNC jack x 1, 1.0 Vp-p/75 Ω [Genlock Input] setting: input only; [HD Sync Output] setting: output only, tri-level HD signal
TIME CODE Terminal	BNC jack (input and output), input: 0.5 - 18 Vp-p/100 kΩ Output: 1.3 Vp-p/50 Ω or less
HDMI OUT Terminal	HDMI connector x 1, output only Assistance displays can be output (onscreen displays, peaking).
RS-422 Terminal	RJ45 connector x 1
INPUT 1 Terminal INPUT 2 Terminal	INPUT (3-pin jack) (pin1: shield, pin2: hot, pin3: cold), 2 sets, balanced Sensitivity (MIC): -60 dBu (Manual volume center, full scale -18 dB)/Att.: 20 dB Sensitivity (LINE): +4 dBu (Manual volume center, full scale -18 dB) Power supply: 48 V DC
MIC Terminal	Ø3.5 mm stereo mini jack (unbalanced, plug-in power supported) Sensitivity (MIC): -72 dBV (Manual volume center, full scale -18 dB)/Att.: 20 dB Sensitivity (LINE): -10 dBV (Manual volume center, full scale -18 dB) Power supply: 2.4 V DC

■ Others

Operating/Storage Environment	Temperature: 0°C – +40°C (+32°F – +104°F) Humidity: 10% – 90% (without condensation)
Power Supply	PoE: PoE++ power supply via LAN connector (IEEE802.3bt compliant) (PoE and PoE+ cannot be used) External power supply: 12 V DC supported Input: 10.8 V – 20 V DC, 3.5 A (acceptable maximum load current) 4-pin XLR connector
Power Consumption	PoE++ Input: Approx. 37.4 W* max. (body only) DC Input: Approx. 36.7 W max. (body only) * Class 5 (40.0 W required) for power supply devices
Dimensions (W x H x D)	Approx. 200 x 269 x 208 mm (7.87 x 10.59 x 8.19 in.) (excluding protrusions)
Weight	Approx. 4.4 kg (9.7 lb.) (body only)
Supported Controllers	Hardware: RC-IP100, RC-IP1000 Software: Remote Camera Control Application

Accessories

■ IR Remote Controller

Power Supply	DC 3.0 V Battery size AAA x 2 are used.
Reach Distance	Approx. 8 m (26.2 ft.) vertical and horizontal $\pm 25^\circ$ (front of light receiver)
Body dimensions (W x H x D)	46.5 x 25 x 159 mm (1.83 x 0.98 x 6.26 in.)
Weight	Approx. 60 g (0.14 lb.)

Operating Environment

For either environment, setting conditions and video display/audio support is as follows.

- Must be configured to allow use of JavaScript, and web storage
- Only JPEG format is supported for displaying video
- Does not support audio

■ Settings Page (Computer Environment)

OS	Windows 11 Windows 10 64-bit	macOS 14
CPU	Intel Core i7-8700 or greater	
Memory	8 GB or more	
Web Browser	Microsoft Edge (Chromium), Google Chrome	Safari
Display	Resolution 1920x1080 or greater	

■ Settings Page (Verified Mobile Environments)

- As of April 2024

OS	iOS 17, iPadOS 17	Android 14
Web Browser	Safari	Google Chrome

Security Measures

If the camera is connected to a network and used, it may become a target of cyber attacks such as unauthorized access from unintended third parties. Since this camera has a variety of server functions built in, although they can be convenient, there is a risk of being attacked by a third party unless operated with security measures. To completely eliminate all risks is impossible, however, by studying various risk angles and taking measures based on the security policies, it is possible to decrease the risk of cyber attacks.

This section explains the security hardening measures to the camera settings. Refer to this section and implement necessary measures according to the environment under the customer's responsibility, which will lead to safer camera operation. System administrators are advised to read.

Important

To the full extent permitted by laws and regulations, neither Canon Inc. nor any of its subsidiaries or affiliates shall be liable for any losses, direct, incidental or consequential damages, or liabilities that may be incurred as a result of network security incidents such as unauthorized accesses.

The security hardening measures explained in this section are mainly for the cameras, which are a part of an entire system as shown in the figure below. For the entire system's security hardening, measures must be taken according to the customer's network environment and/or purpose of the camera use.

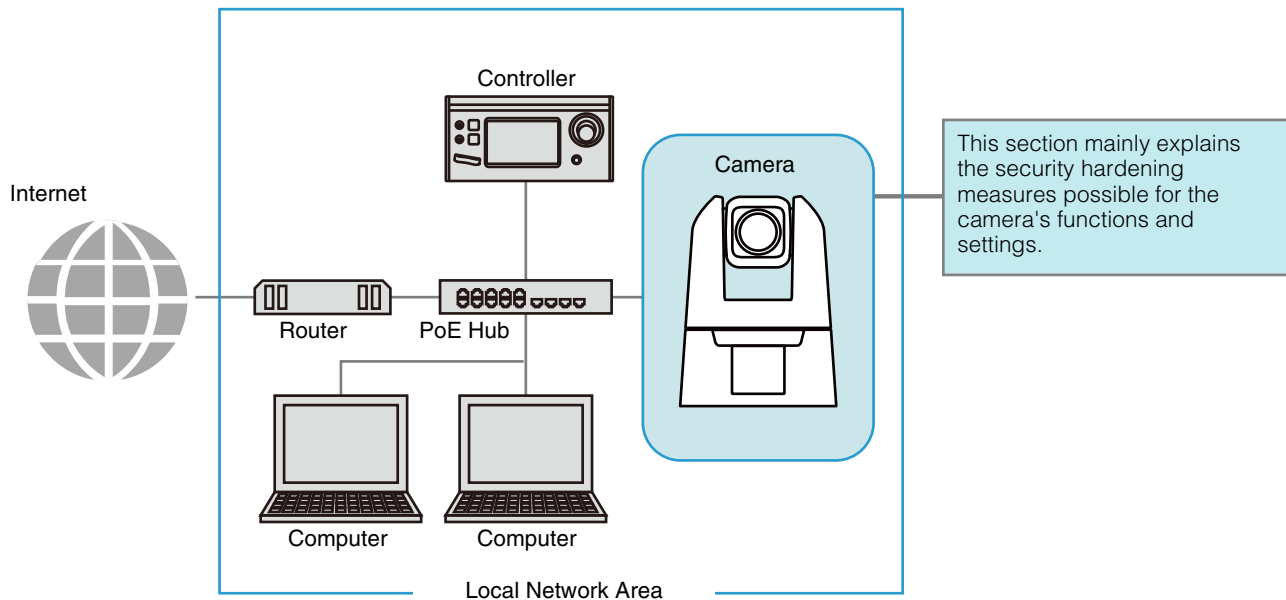

In order to reduce the security risk, it is effective to block access physically and/or virtually if it is unnecessary to be made accessible from an external network, such as the internet.

When access from a remote location is unnecessary and the devices accessing the camera can be limited, using only specific devices in the same local area network will enhance security. When it is necessary to access the camera from a remote location, it is important to use a method that can communicate safely, such as using a VPN (Virtual Private Network) that can block access from the outside.

Basic Measure 1: Setting Administrator Name and Password

The administrator account has authority over all of the camera's settings and operations. If the administrator account is illegally used by an unauthorized party and tampering is done, there is a risk the camera will not be accessible. In order to prevent spoofing of the administrator account, the most fundamental measure for safe operation of the camera is to make the administrator name and password in an array of letters that are difficult to guess by unauthorized users. Strictly manage the administrator account and refrain from settings such as the same administrator account on multiple cameras. The administrator account needs to be set when the camera is started for the first time. After setting, editing can be done on the camera's Settings Page (P. 89).

■ Setting a Strong Administrator Name and Password

In order to strengthen the administrator name and password, consider the following points:

- Combine at least 10 characters of alphanumeric characters or symbols and special characters permitted for the camera.
- Combine upper and lower case characters.
- Avoid commonly used words and string of characters that are easy to guess.

■ Other Passwords

For the camera, in addition to the administrator account, the password for Wireless LAN (P. 78), Server Certificate (P. 86), Authorized User (P. 89), and Encrypting Backup Information (P. 102) are to be set. Set these passwords in an array of letters that are difficult to guess by unauthorized parties and manage them appropriately.

Basic Measure 2: Using the Latest Firmware

The camera's firmware is updated as needed in order to improve performance of the functions and bug fixes. From the security point of view, it is important to always keep it updated because the measures against known vulnerabilities are applied to the latest firmware.

Check Canon's website regularly, at the initial setting after purchasing the camera and during its operation, to verify whether the latest firmware is provided.

The firmware version can be confirmed and updated on the camera's Settings Page (P. 100, P. 104).

Basic Measure 3: Setting Date and Time

Set the correct date and time for the camera. It is recommended to set the time to an NTP server if connected to the Internet. If there are indications that suspicious unauthorized access occurred, it may be possible to confirm the date and time of occurrence by checking the log.

Date and time is set on the camera's Settings Page (P. 97).

Basic Measure 4: Monitoring the Log

Camera connection status and operating conditions are recorded and saved as a log in the camera embedded memory.

Check the logs periodically to quickly find any signs of suspicious unauthorized access, such as repeated user authentication failures. For details on the log, refer to "List of Log Messages" (P. 113).

The logs will be deleted if any of the following operations are performed: rebooting, initialization, and restoring to the factory default settings.

The log will also be deleted if exceeding a certain size.

The log saved in the camera embedded memory can be confirmed on the camera's Settings Page (P. 105).

Measures Suitable to the Users' Environment 1: User Management

"Administrator", "authorized user", and "guest user" are the three types of accounts that are able to access the camera. The administrator account has authority over all of the camera's settings and operations. Only the administrator account can access the [System] menu on the Settings Page. Therefore, in order to prevent leaks to unauthorized users, it is important to strictly manage information on the administrator account.

In addition to the administrator, an authorized user and guest user with privileges granted can access the camera from a controller or access the Settings Page. The administrator should understand what an authorized user and guest user are able to do, and set the minimum necessary authorization level and users.

"Authorized Users" Means Users Who Require Authentication

To allow only specific users, except the administrator, to control the camera and distribute the video, set up an authorized user. In the authorized user settings, register account information (user name and password) and grant privileges (allow video distribution only, allow camera control, etc.). The same authority is given to all authorized users, therefore it is necessary to be careful to give authority to authorized users. Regularly review and manage the authorized users, and set the minimum necessary authorization level and users.

It is important to disable all the authorities of the guest users, which is described later, when wanting to restrict access to only authorized users. Unless these are disabled, access from the guest users will not be restricted.

"Guest Users"

Guest user means a guest account which does not need a user name and password. By enabling authorities for the guest users, anyone will be able to access the camera without requiring user authentication. Also, this would allow camera control and video distribution commands without authentication. Therefore, guest users authority should be set only when security is ensured, for example, if used within the network that prohibits the external access, etc., otherwise disable all authority of the guest users.

When allowing access by guest users, grant only the minimum necessary privileges to them, since the same privileges are given to all guest users, just as to all the authorized users.

User management is set on the camera's Settings Page (P. 88).

Measures Suitable to the Users' Environment 2: Host Access Restrictions

By specifying the hosts that can access the camera, the risk of unauthorized access can be reduced.

In order to restrict hosts to access the camera, allow communication with only specified hosts, and prohibit all other communication. Oppositely, there is also the method of prohibiting communication with specified hosts and allowing communication with all others.

Depending on the user's environment, the range of access restriction can be grouped on a network basis, or it can be set for each host. However, if mistakenly setting the administrator's IP address to prohibit communication, access from the administrator to the camera will be prohibited and there will be no other way than to restore to the factory default settings. Caution is needed when setting the access restrictions.

Host access restrictions are set on the camera's Settings Page (P. 90).

Measures Suitable to the Users' Environment 3: Setting to the Digest Authentication

When accessing the cameras via [HTTP Server] and [RTP Server], select [Digest Authentication] for the authentication method. When [Basic Authentication] is selected, the password can be easily leaked to unauthorized parties because the password will be sent on the network without being encrypted.

It is necessary to set the authentication method of the HTTP Server and the RTP Server respectively. Authentication method is set on the camera's Settings Page respectively (P. 72, P. 73). Confirm that the application supports the Digest Authentication.

Measures Suitable to the Users' Environment 4: Changing the Port Number

It is important to limit unspecified access to prevent unauthorized access to the camera. The port number is an entrance to the communication between the camera and the external device, and a number is set for each communication protocol. A common number is used for the port number and network devices can be connected easily.

Thus, there is a risk of it being used for intrusion by unauthorized parties. In case there is a need to change the port number due to concern of security, make sure that the port numbers are not redundant with those of other communication protocols, and set it within the specified range. If the port number is changed, specify the port number in addition to the IP address in order to access the camera.

Example: Changing the Port Number

When connecting by the HTTPS, set "https://{Camera's IP address}:{Port Number}".

When the HTTPS port number is changed to 10443

https://192.168.100.1:10443

HTTP Port Numbers/HTTPS Port Numbers

HTTP/HTTPS port number is set on the camera's Settings Page (P. 72)

It is also possible to change the following port numbers:

- RTSP Port (P. 73)
- Multicast Port (P. 73)

Measures Suitable to the Users' Environment 5: Encrypting Communication

In order to securely communicate between the camera and the external device, it is recommended that all communication be via HTTPS connection (encrypted communication combining SSL/TLS and HTTP). SSL (Secure Sockets Layer)/TLS (Transport Layer Security) is a technology to encrypt communication on the network and prevent hacking and tampering of communication contents by an unauthorized party. Even if the data is hacked during communication, by encrypting the communication in the proper way, the contents of the data are protected and safety can be secured.

Self-Signed Certificate and Server Certificate

To encrypt communication via HTTPS connection, use a self-signed certificate or a server certificate issued from a CA (Certificate Authority). Self-signed certificates are sufficient to do encryption, however, a warning screen will be displayed in the web browser, and there is a risk of impersonation. Therefore, it is advised to use it in the cases for an operation test and others.

It is recommended to acquire and install a server certificate issued from CA for a full-scale system operation.

Encrypting communications by HTTPS connection is set on the camera's Settings Page (P. 87).

Note

Even if setting the HTTPS connection as mentioned above, the video delivered via RTP/RTSP cannot be encrypted (SRT delivery can be encrypted). In order to securely communicate the video to deliver, it is necessary to deal with the whole system.

Measures Suitable to the Users' Environment 6: Disabling Unused Functions

The camera has functions to support various purposes and network environments. However, unless those functions are properly set, there is a risk of unauthorized access from outside parties. In order to use the camera safely, it is also necessary to disable the setting of unused functions.

The following describes the functions that need to be addressed in the operating environment and usage situation, such as enabling only the necessary functions or disabling the functions after the setting is completed.

AutoIP

When [AutoIP] (P. 76) is enabled, even in environments where there is no DHCP server, IPv4 link-local addresses (169.254.xxx.xxx) are assigned to the camera. Therefore, by assigning a computer to the same network as the IPv4 address and using the Camera Search Tool, the camera can be detected and initial settings can be made.

Although [AutoIP] is enabled by factory default settings, it is recommended to disable [AutoIP] when the initial setting of the network is completed so that it will not be used for unauthorized purposes.

mDNS (multicast Domain Name System)

[mDNS] (P. 77) is a function to notify devices on the network of the camera IP address and host name information simultaneously so that the camera can be detected even in an environment without a DNS server.

In the factory default settings, the setting of [mDNS] is enabled, but to prevent unauthorized use by third parties, disable it after the initial network settings are completed.

Wireless LAN

[Wireless LAN] (P. 78) allows users to access and operate the camera directly.

If it is unnecessary to connect the camera to a computer or mobile device using a Wireless LAN, set [Wireless LAN] to [Disable].

RTP (Real-time Transport Protocol)

By using [RTP Server] (P. 73), video and audio data can be delivered to the specified multicast address. It is recommended to set [RTP] to [Disable] when the devices connecting to the camera do not require RTP protocol.

Standard Communication (IP), NDI|HX, RTMP, Output Tracking Data, SRT

When using [Standard Communication (IP)], [NDI|HX], [RTMP], [Output Tracking Data] and [SRT], it is possible to distribute videos using each protocol, operate the camera, etc. (P. 80)

If it is unnecessary to connect the camera to a device using these protocols, set each item to [Disable].



Important

- [Video Distribution] under the [User Authority] (P. 89) is not reflected to the RTP.
- When using NDI|HX, RTMP, SRT or tracking data output, access cannot be controlled by [User Management] (P. 88).

Precautions When Disposing the Camera

When disposing the camera, initialize the camera and delete all setting information such as network settings and administrator account.

For camera initialization, refer to Settings Page (P. 100). When disposing the camera, set [Network Settings] to [Do not save]. If unable to access the Settings Page, use the RESET switch on the camera to restore to the factory default settings.

Encrypting Backup Information

The backup information of the camera settings is used when restoring the camera to the user's previously saved settings. It is possible to manage the backup information more securely by setting [Encryption Password] for the backup information. Handle the set password with care.

Backup information encryption is set on the camera's Settings Page (P. 102).

Index

A

Access Point	78
Add-On	95
Administrator	88
Administrator Account	89
AE Response	29
AE Shift	28
AF (Auto Focus)	33
Application	95
Assistance Settings	60
Audio	69
Audio Settings (RTP)	73
Authorized User	88
Authorized User Account	89
Autofocus	33

B

Backup/Restore	102
Bit Rate Control	68

C

Camera Name	91
Camera Search Tool	14
Canon 709	38
Canon Log 3	39
Certificate Management	86
Cinema Gamut	40
Color Bars	49, 92
Color Matrix	40
Color space	40
Create Certificate	86
Custom Picture Settings	38

D

Date and Time	97
DCI-P3	51
Device Information	100
Diffraction Correction	29
Digital Tele-Converter	24, 45
Digital Zoom	24, 45
DISP Level	57
DNS	76

E

Editing Custom Picture settings	40
Encrypted Communications	87
Environment	99
Error Log	113
Exposure	25
External Connection (IP)	80
External Connection (Serial)	84
Eye Detection	34, 37

F

Face Detection AE	34, 37
Face Detection AF	34
Factory Default Settings	124, 126
Fan Mode	92
Firewall	13
Flicker Reduction	29
Focus	33
Frame Frequency (Hz)	99
Framerate (fps)	67

G

Gain (dB)	28
Gamma	39
Gamma/Color Space	39
General Audio	69
Genlock	93
Guest User	88

H

HDMI/SDI	65
Host Access Restrictions	90
HTTP Server	72

I

Image Stabilizer	45
Infrared Shooting (IR)	26
Initial Settings	14
Initialization	100
Installation Conditions	91
IP Audio Streaming	70
IP Streaming Video	67
IPv4 (Wired LAN)	75

IPv4 (Wireless LAN)	79
IPv4 Host Access Restrictions	90
IPv6 Host Access Restrictions	90
IR Remote Controller	92, 106
Iris (Aperture Value)	26
IS (Image Stabilizer)	45
ISO Speed	28

K

Knee	41
------------	----

L

LAN	75
Language	21
Light Metering	29
Limit for Auto Mode	28
Log Messages	113
Look Files	43
LUT	51

M

Mainstream	67
Manual Focus	36
Markers	61
mDNS	77
MF (Manual Focus)	36
Movement Limit	71

N

ND Filter	26
NDI HX	80
Network	75
Noise Reduction	41
Notification log	119

O

Onscreen Displays	58
Operating Environment	135
Other Functions	49
Output Range	55
Output Tracking Data	81

P

Pan	23
Peaking	60
Power ON	21

Preset	46
PTZ	45

R

Reference sync signal	93
RESET Switch	124
RTMP	81
RTP Server	73
RTP Stream	74

S

SDI	66
Security Measures	136
Serial Port	84
Server	72
Server Certificate	87
Server Certificate Management	86
Settings Page	18, 20
Sharpness	41
Shooting Mode	25
Shutter Mode	27
Specifications	132
SRT	82
SSL/TLS	87
Standard Communication (IP)	80
Standard Communication (Serial)	85
Standby	21
Substream 1	68
Substream 2	68
System	62

T

Tally Lamp	20, 92
Tilt	23
Time Code	93
Time Code Input/Output	93
Troubleshooting	111

U

Update Firmware	104
User Authority	89
User Management	88

V

Video Codec	67
Video Server	72
Video Size	67

View Assistance 51
View Logs 105

W

Warning log 116
WB (White Balance) 31
White Balance Mode 31
Wireless LAN 18, 78

Z

Zoom 23

